



Product Catalogue



ABF *Low Pressure* *Centrifugal Fan*



Technical Specifications

LOW PRESSURE CENTRIFUGAL FAN

ABF series are single suction high efficiency and low noise fans. The maximum temperature of the suction fluid should be 120 ° C. In order to work at a higher temperature, modifications to the fan manufacturing are required.

Made of high quality corrosion resistant S355 steel and coated with epoxy paint. Can be made of stainless steel for corrosive and high temperature environments. Fans are radial fans with backward curved blades. It is possible to drive the fan with belt pulley, direct coupling or elastic coupling.

Optionally, it can be manufactured with Ex-Proof feature.

Usage Areas

It can be used for suction of clean and light dusty fluids, cooling, ventilation, drying, mechanical extraction and toxic gas exhaust.

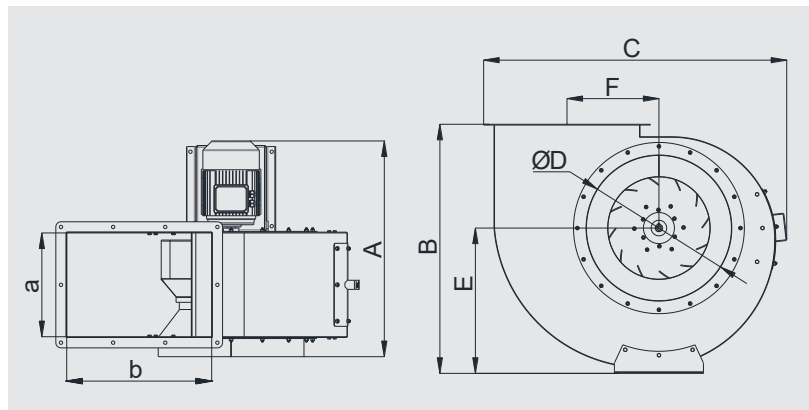
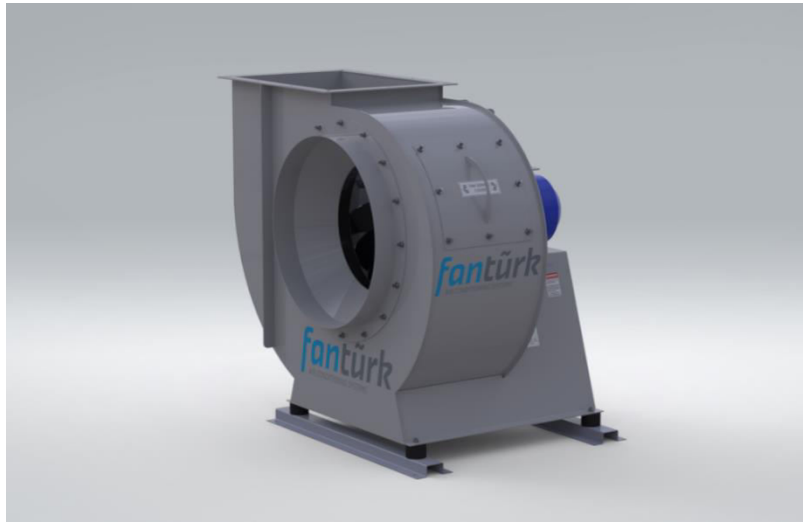

MODEL	A	B	C	Inlet	Outlet	E	F	VOLTAGE	FREQUENCY	MOTOR POWER	CURRENT	MOTOR SPEED	SOUND PRESSURE LEVEL	WEIGHT
	mm	mm	mm	ØD	a x b									
ABF 250/0,25	500	645	775	380	355 x 250	379	230	380	50	0,25	0,9	1360	64	49
ABF 250/0,37	500							380	50	0,37	1,2	1360	65	50
ABF 250/2,2	575							380	50	2,2	4,5	2850	77	58
ABF 250/3	640							380	50	3	6	2900	78	63
ABF 280/0,55	670	720	860	420	400 x 280	408	250	380	50	0,55	1,6	1370	67	63
ABF 280/4	730							380	50	4	7,4	2900	79	76
ABF 280/5,5	560							380	50	5,5	11	2900	82	93
ABF 315/1,1	635	800	940	460	450 x 315	462	280	380	50	1,1	2,6	1390	70	84
ABF 315/7,5	765							380	50	7,5	13,6	2900	84	114
ABF 315/11	900							380	50	11	19,5	2930	85	143
ABF 355/0,37	635	880	1065	520	500 x 355	523	328	380	50	0,37	1,2	930	60	95
ABF 355/0,55	635							380	50	0,55	1,6	930	62	98
ABF 355/2,2	745							380	50	2,2	5	1420	72	106
ABF 355/15	945							380	50	15	28,3	2935	79	166
ABF 355/18,5	945							380	50	18,5	34	2935	82	177
ABF 400/1,1	730	960	1160	565	560 x 400	560	355	380	50	1,1	2,9	930	65	114
ABF 400/4	800							380	50	4	8,2	1430	73	135
ABF 450/2,2	850	1090	1320	640	630 x 450	640	400	380	50	2,2	5,4	950	68	167
ABF 450/5,5	910							380	50	5,5	11,2	1440	75	182
ABF 450/7,5	910							380	50	7,5	15,4	1450	76	194
ABF 500/4	970	1280	1480	725	710 x 500	731	460	380	50	4	9	960	71	240
ABF 500/11	1100							380	50	11	21	1460	78	290
ABF 500/15	1100							380	50	15	29,3	1460	79	300
ABF 560/5,5	1030	1525	1650	810	800 x 560	945	510	380	50	5,5	12,3	950	74	360
ABF 560/7,5	1165							380	50	7,5	15	960	75	395
ABF 560/18,5	1240							380	50	18,5	34,5	1460	82	479
ABF 560/22	1240							380	50	22	42,5	1460	83	490

Fan Directions



The centrifugal fan direction must be specified when ordering.

To determine the fan direction, one of the following options is selected when looking from the motor side.

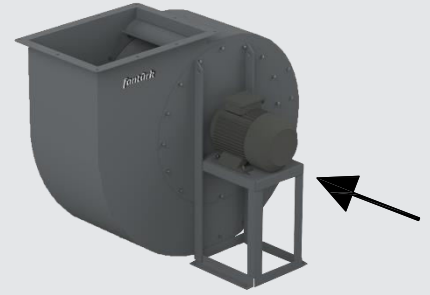

Counter Clockwise 	TR Top Right 	TR45 Top Right 45° 	LT Left Top 	LT45 Left Top 45°
	BL Bottom Left 	BL45 Bottom Left 45° 	RB Right Bottom 	RB45 Right Bottom 45°
	TL Top Left 	TL45 Top Left 45° 	RT Right Top 	RT45 Right Top 45°
	BR Bottom Right 	BR45 Bottom Right 45° 	LB Left Bottom 	LB45 Left Bottom 45°
Clockwise 				

Performance Curves

ABF 250/0,25

Voltage 380 V
Frequency 50 Hz
Motor Power 0,25 kW
Motor Speed 1360 rpm
Sound Pressure Level 64 dBA
Weight 49 kg

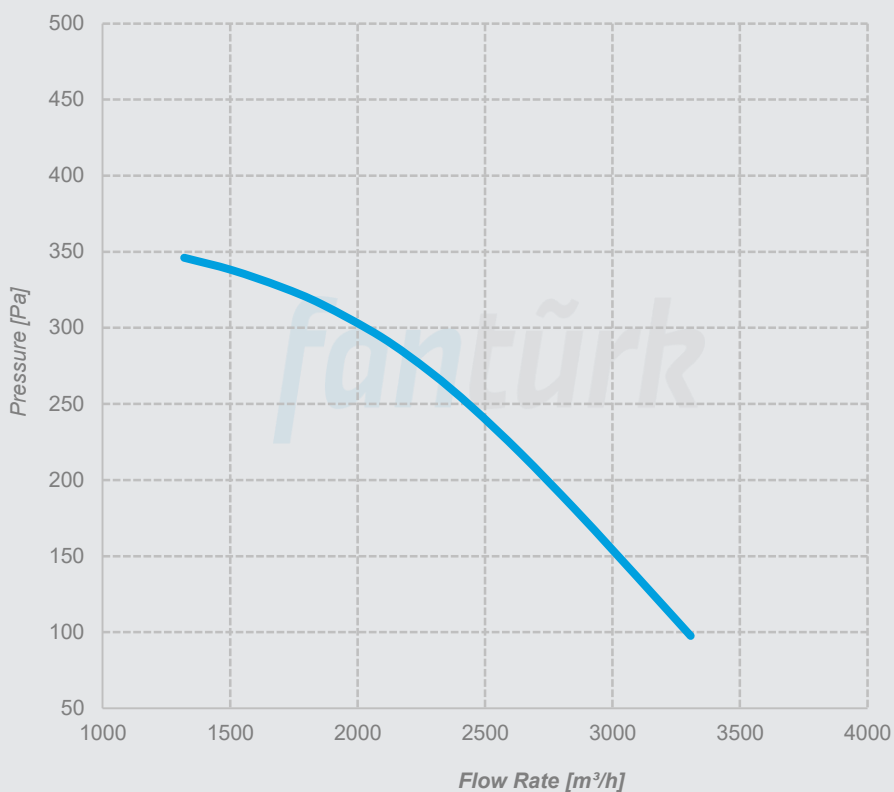

ABF 250/0,37

Voltage 380 V
Frequency 50 Hz
Motor Power 0,37 kW
Motor Speed 1360 rpm
Sound Pressure Level 65 dBA
Weight 50 kg

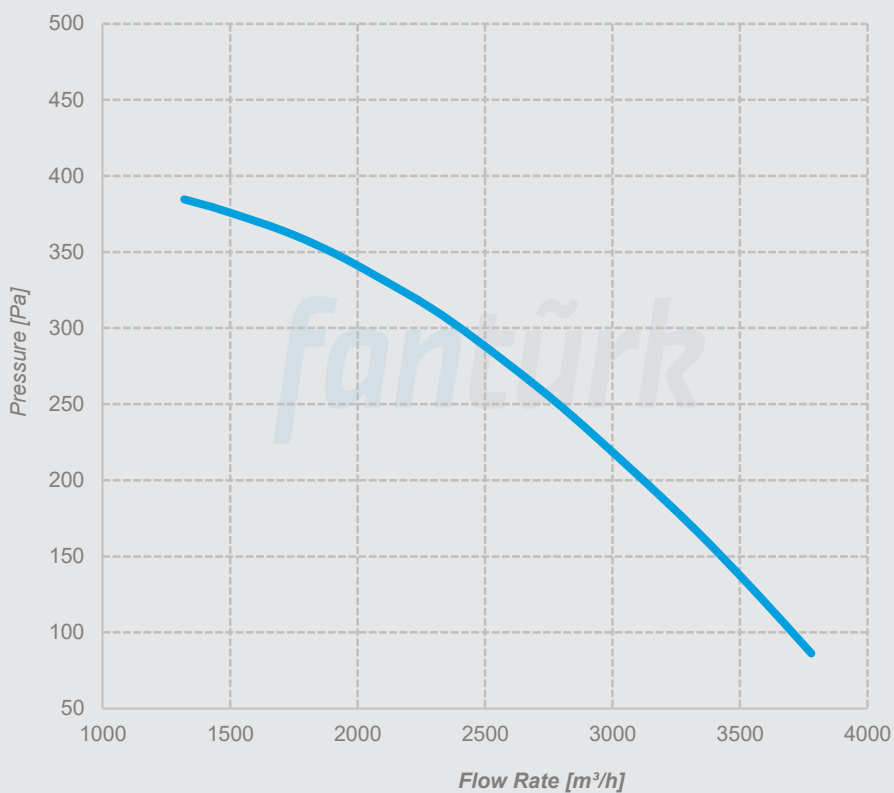

Performance Curves

ABF 250/2,2

Voltage 380 V
Frequency 50 Hz
Motor Power 2 kW
Motor Speed 2850 rpm
Sound Pressure Level 77 dBA
Weight 58 kg

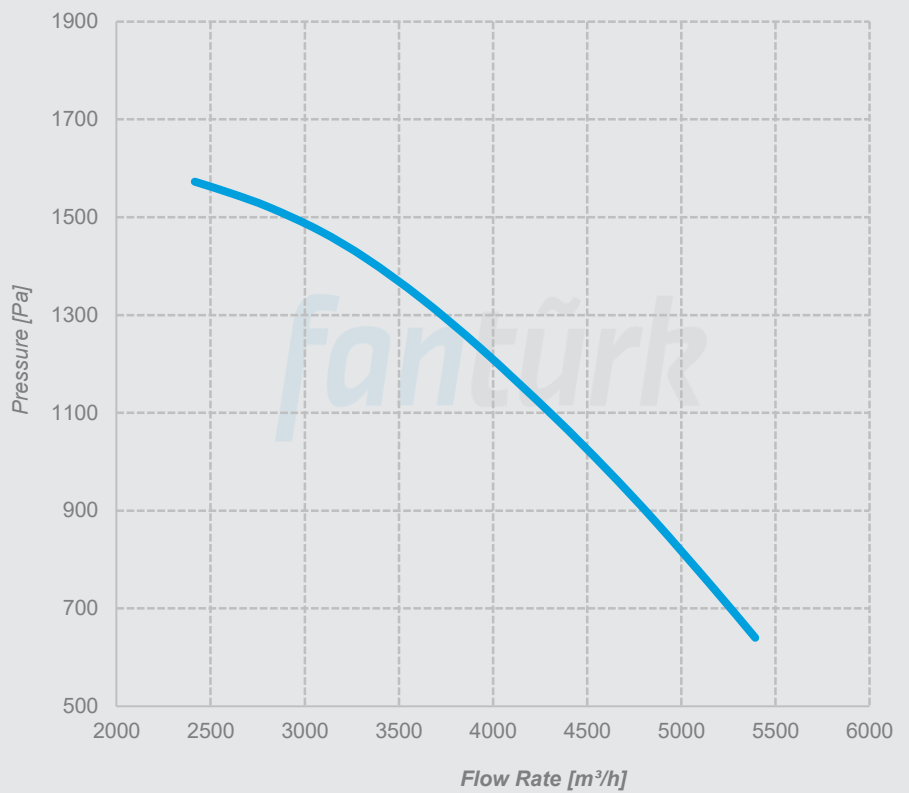

ABF 250/3

Voltage 380 V
Frequency 50 Hz
Motor Power 3 kW
Motor Speed 2900 rpm
Sound Pressure Level 78 dBA
Weight 63 kg

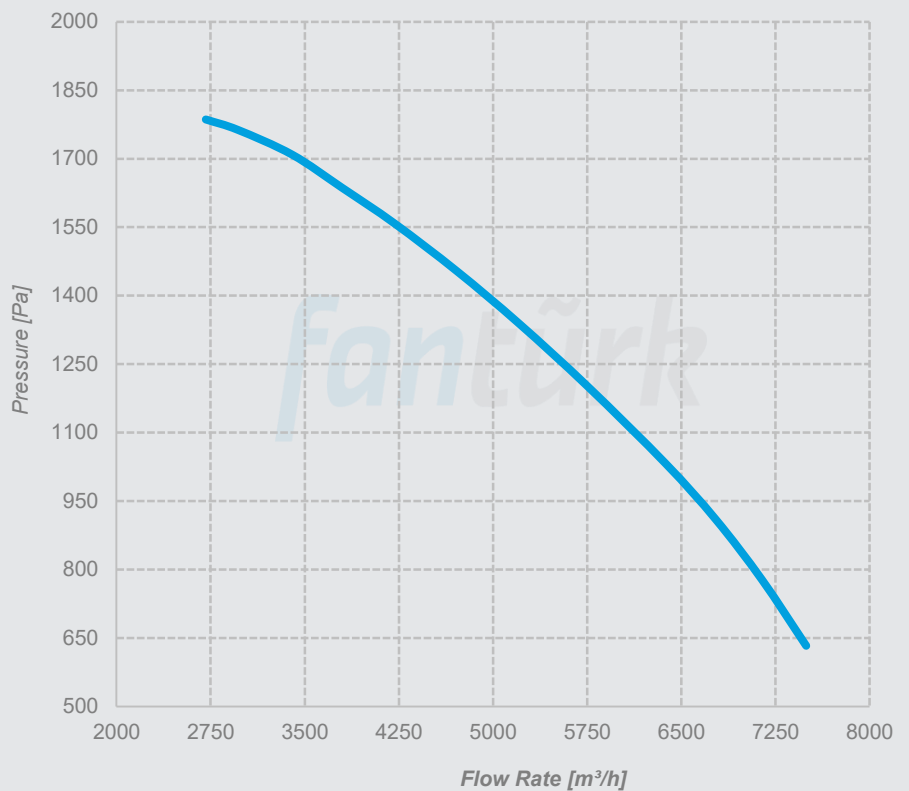

Performance Curves

ABF 280/0,55

Voltage 380 V
Frequency 50 Hz
Motor Power 0,55 kW
Motor Speed 1370 rpm
Sound Pressure Level 67 dBA
Weight 63 kg

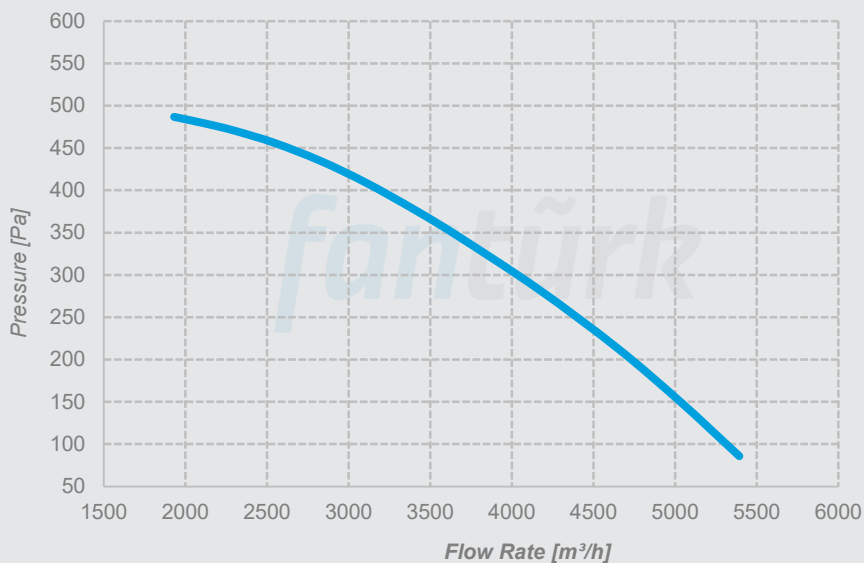

ABF 280/4

Voltage 380 V
Frequency 50 Hz
Motor Power 4 kW
Motor Speed 2900 rpm
Sound Pressure Level 79 dBA
Weight 76 kg

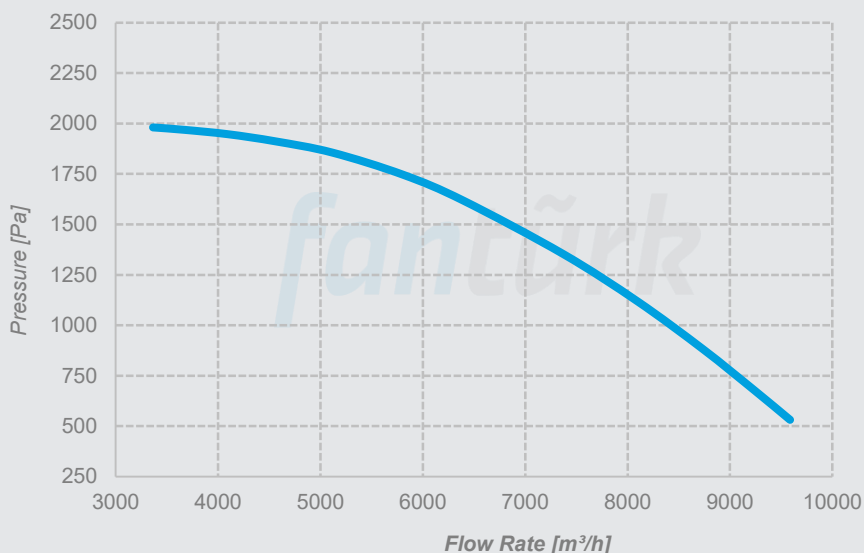

ABF 280/5,5

Voltage 380 V
Frequency 50 Hz
Motor Power 2 kW
Motor Speed 2900 rpm
Sound Pressure Level 82 dBA
Weight 93 kg

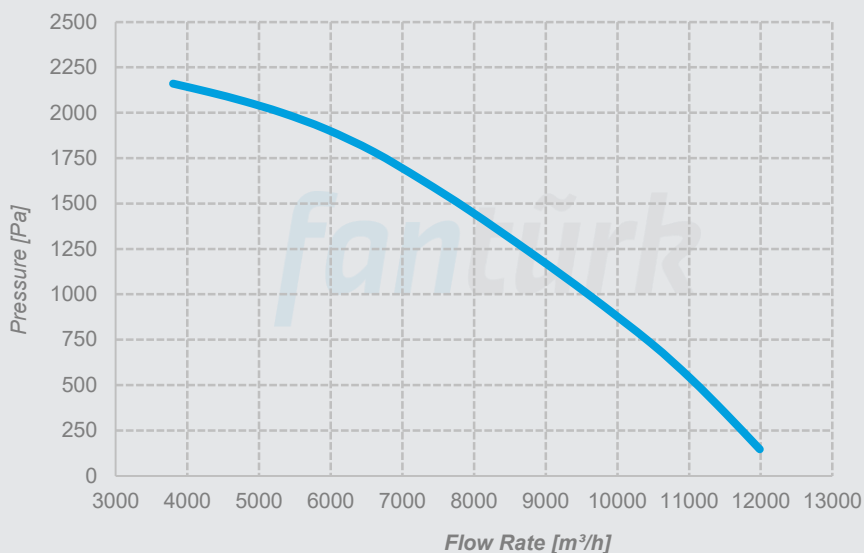

Performance Curves

ABF 315/1,1

Voltage 380 V
Frequency 50 Hz
Motor Power 1,1 kW
Motor Speed 1390 rpm
Sound Pressure Level 70 dBA
Weight 84 kg

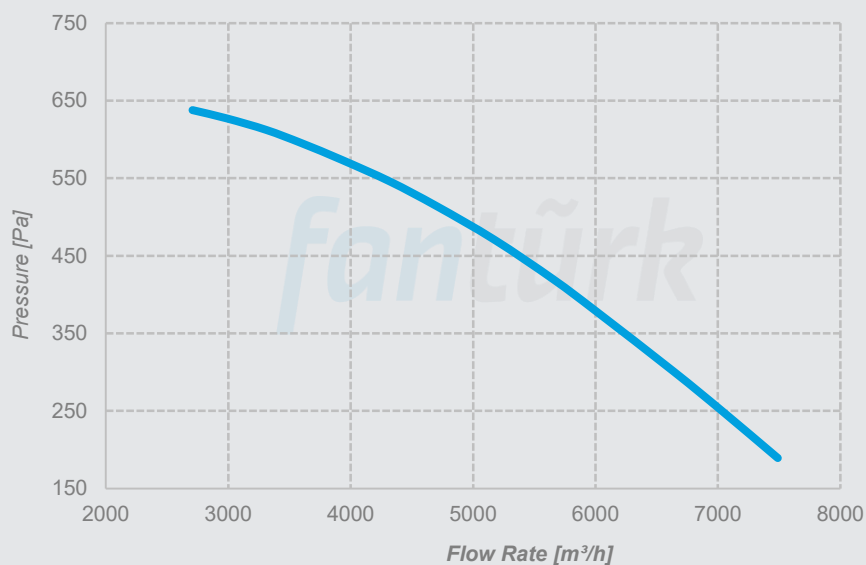

ABF 315/7,5

Voltage 380 V
Frequency 50 Hz
Motor Power 7,5 kW
Motor Speed 2900 rpm
Sound Pressure Level 84 dBA
Weight 114 kg

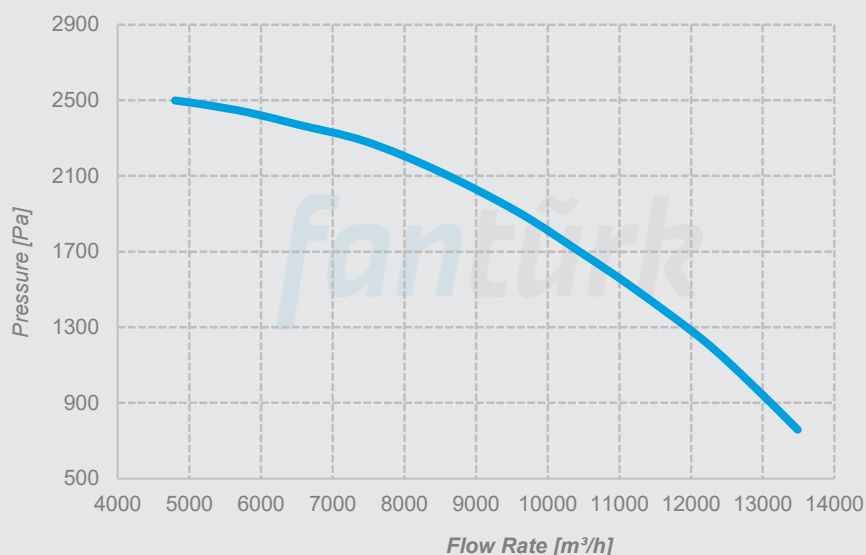

ABF 315/11

Voltage 380 V
Frequency 50 Hz
Motor Power 11 kW
Motor Speed 2930 rpm
Sound Pressure Level 85 dBA
Weight 143 kg

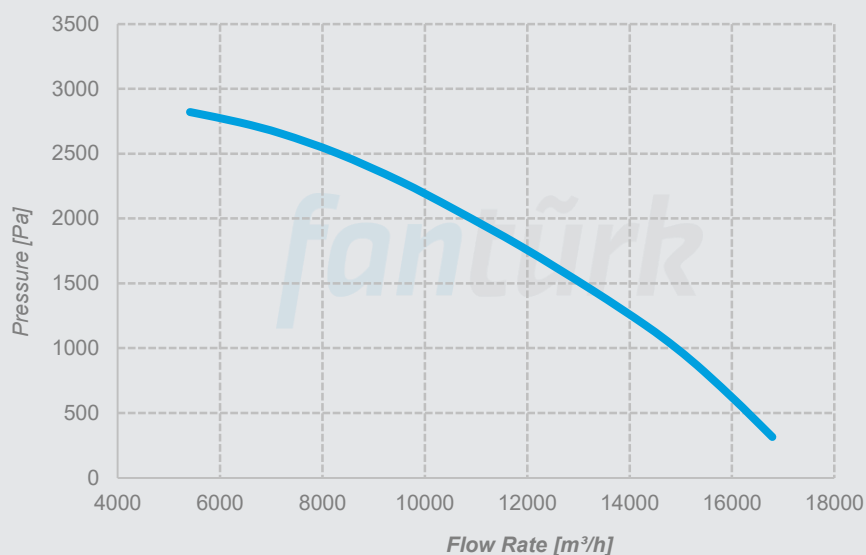

Performance Curves

ABF 355/0,37

Voltage 380 V
Frequency 50 Hz
Motor Power 0,37 kW
Motor Speed 930 rpm
Sound Pressure Level 60 dBA
Weight 95 kg

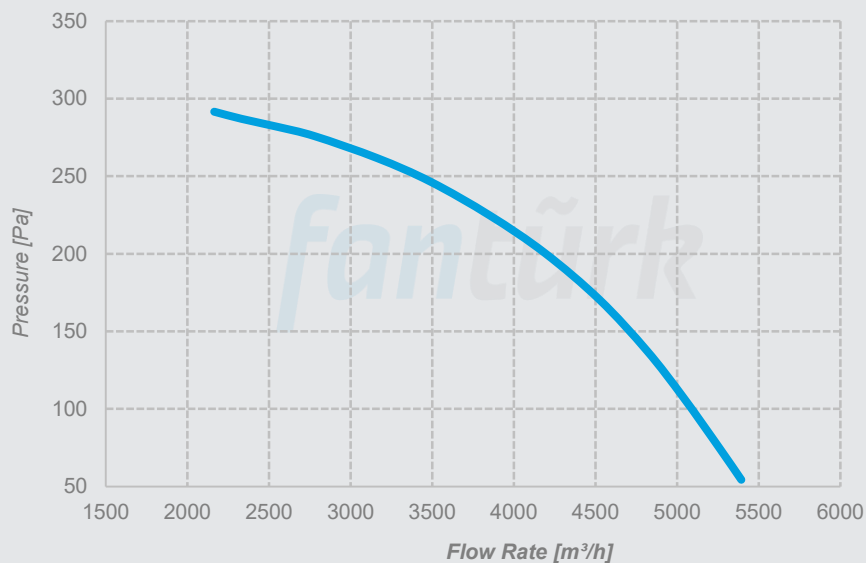

ABF 355/0,55

Voltage 380 V
Frequency 50 Hz
Motor Power 0,55 kW
Motor Speed 930 rpm
Sound Pressure Level 62 dBA
Weight 98 kg

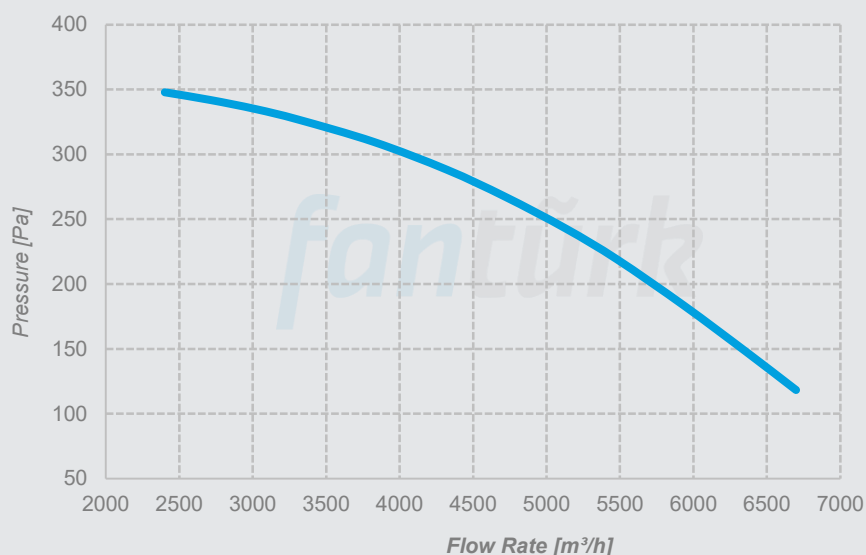

ABF 355/2,2

Voltage 380 V
Frequency 50 Hz
Motor Power 2,2 kW
Motor Speed 1420 rpm
Sound Pressure Level 72 dBA
Weight 106 kg

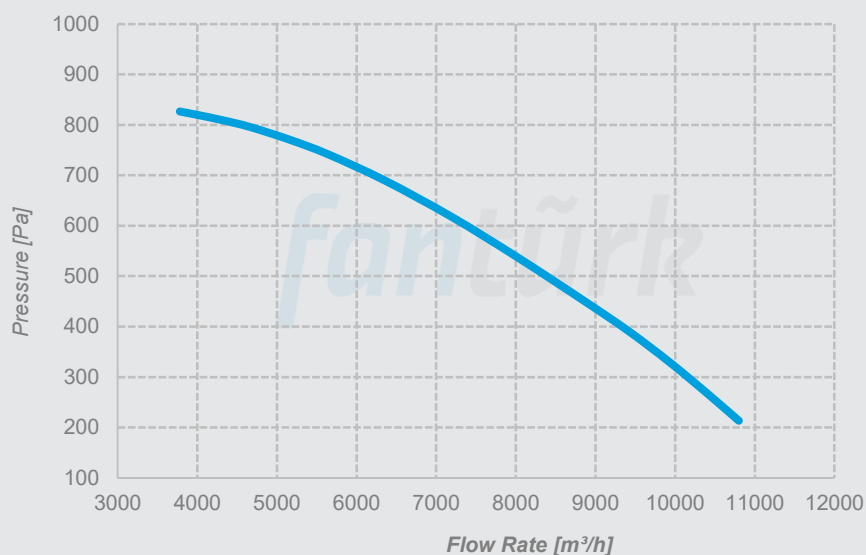

Performance Curves

ABF 355/15

Voltage 380 V
Frequency 50 Hz
Motor Power 15 kW
Motor Speed 2935 rpm
Sound Pressure Level 79 dBA
Weight 166 kg

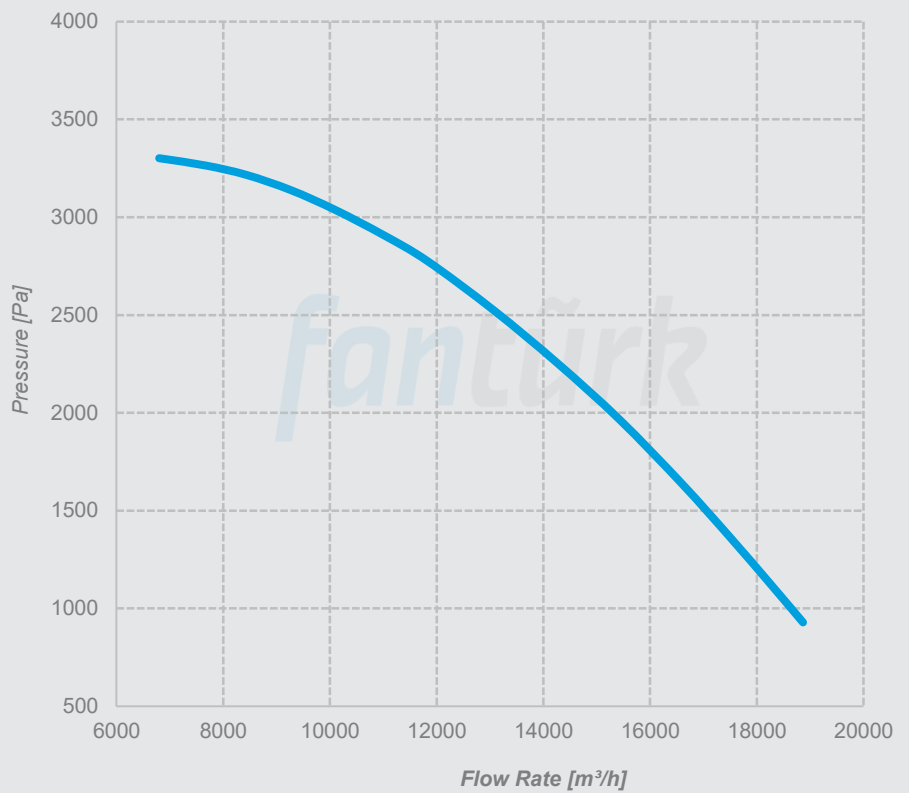

ABF 355/18,5

Voltage 380 V
Frequency 50 Hz
Motor Power 18,5 kW
Motor Speed 2935 rpm
Sound Pressure Level 82 dBA
Weight 177 kg

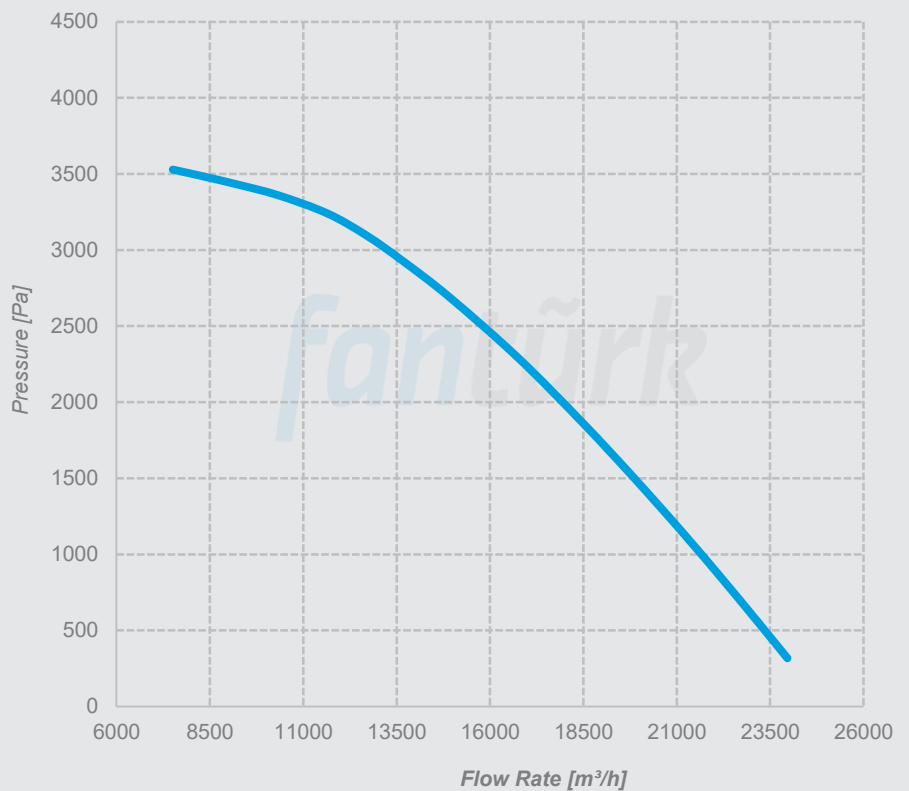

Performance Curves

ABF 400/1,1

Voltage 380 V
Frequency 50 Hz
Motor Power 1,1 kW
Motor Speed 930 rpm
Sound Pressure Level 65 dBA
Weight 114 kg

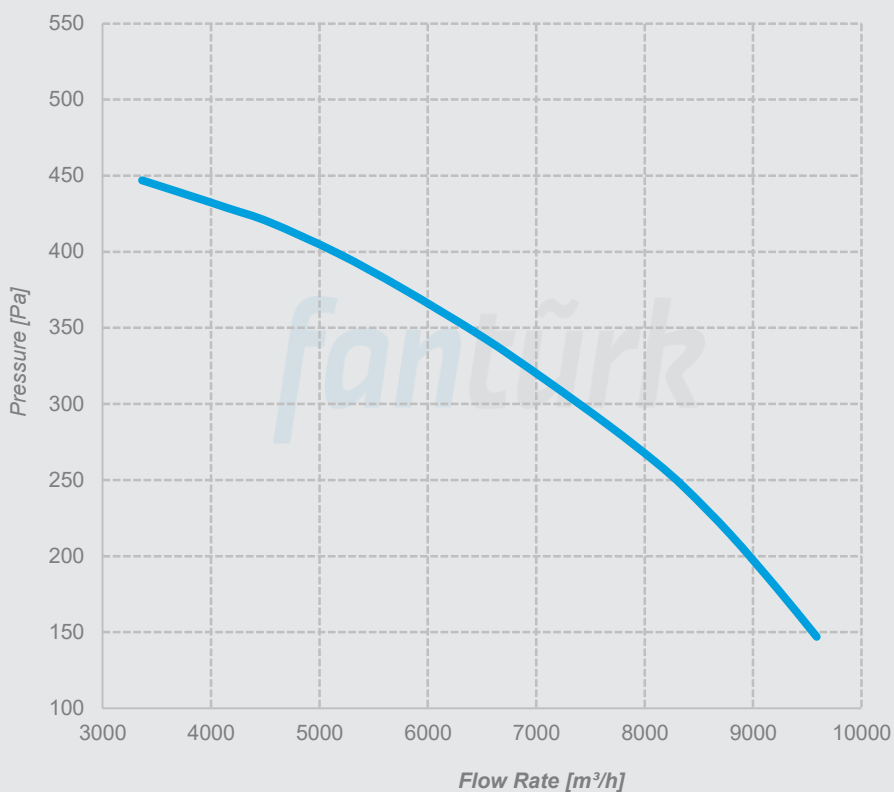

ABF 400/4

Voltage 380 V
Frequency 50 Hz
Motor Power 4 kW
Motor Speed 1430 rpm
Sound Pressure Level 73 dBA
Weight 135 kg

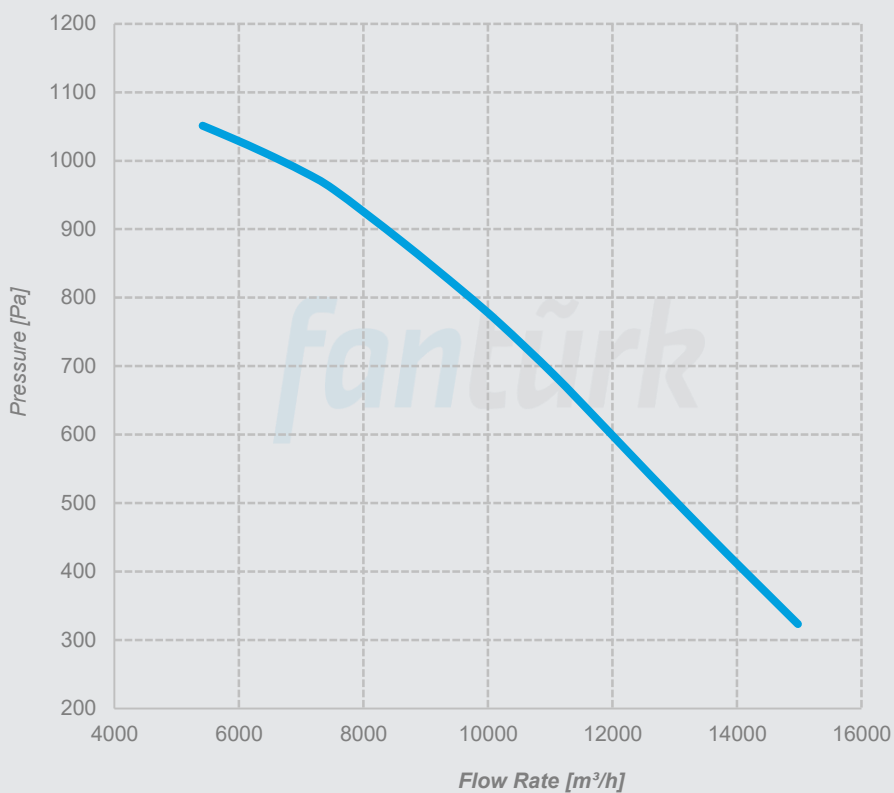

Performance Curves

ABF 450/2,2

Voltage 380 V
Frequency 50 Hz
Motor Power 2,2 kW
Motor Speed 950 rpm
Sound Pressure Level 68 dBA
Weight 167 kg

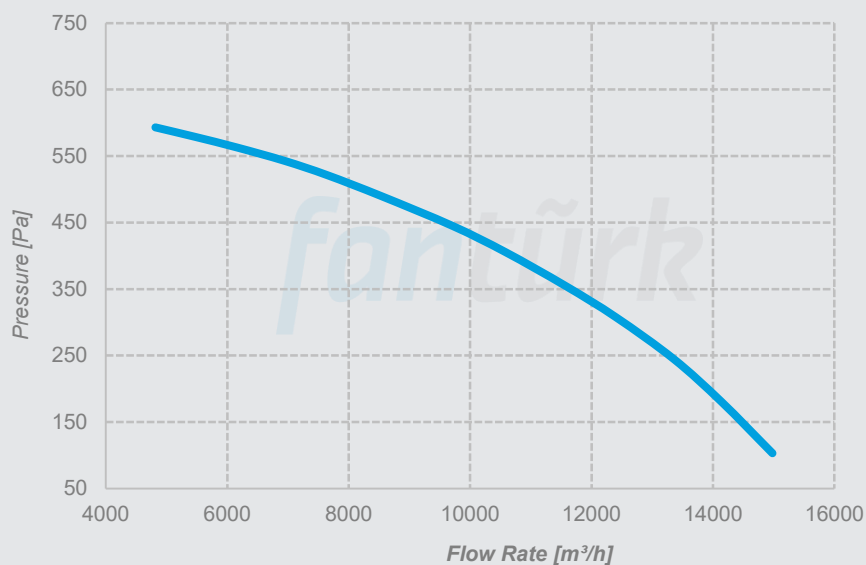

ABF 450/5,5

Voltage 380 V
Frequency 50 Hz
Motor Power 5,5 kW
Motor Speed 1440 rpm
Sound Pressure Level 75 dBA
Weight 182 kg

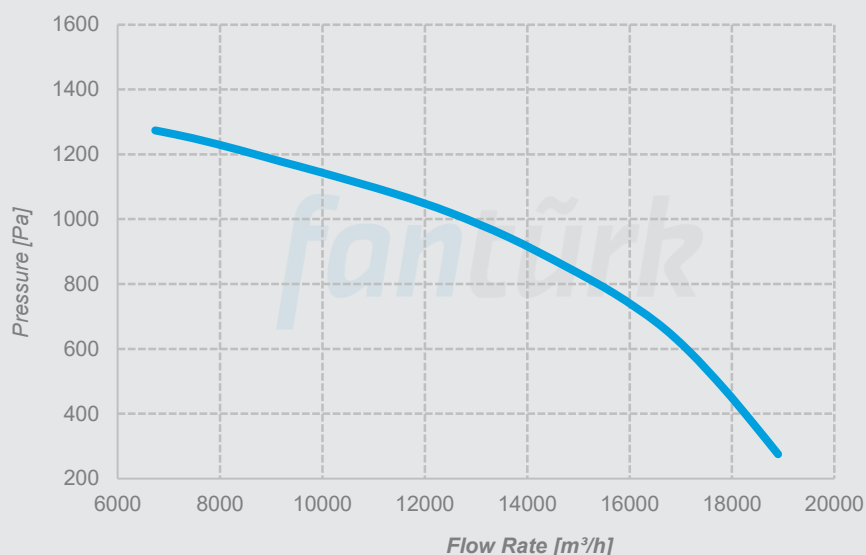

ABF 450/7,5

Voltage 380 V
Frequency 50 Hz
Motor Power 7,5 kW
Motor Speed 1450 rpm
Sound Pressure Level 76 dBA
Weight 194 kg

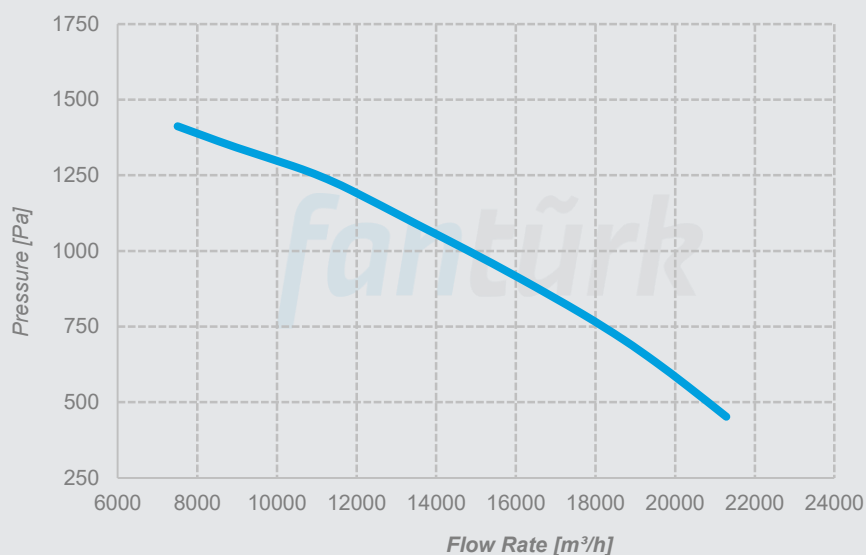

Performance Curves

ABF 500/4

Voltage 380 V
Frequency 50 Hz
Motor Power 4 kW
Motor Speed 960 rpm
Sound Pressure Level 71 dBA
Weight 240 kg

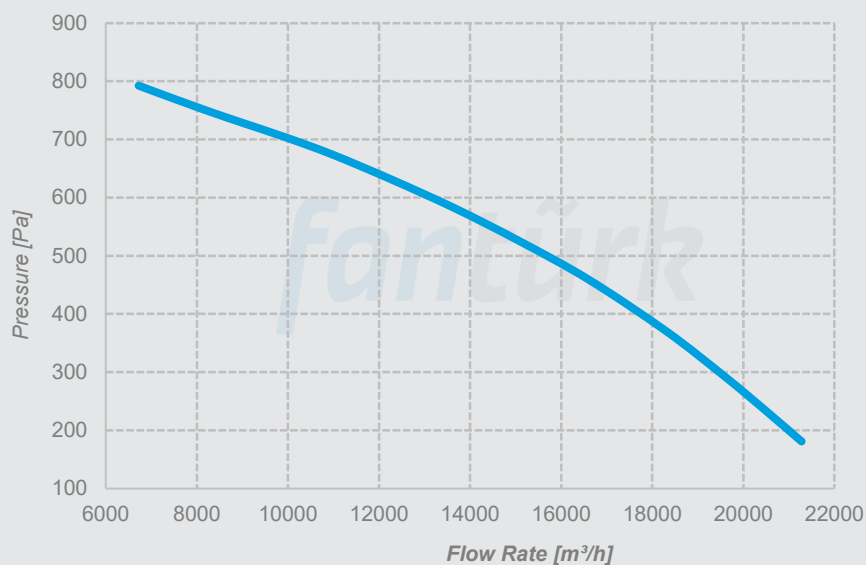

ABF 500/11

Voltage 380 V
Frequency 50 Hz
Motor Power 11 kW
Motor Speed 1460 rpm
Sound Pressure Level 78 dBA
Weight 290 kg

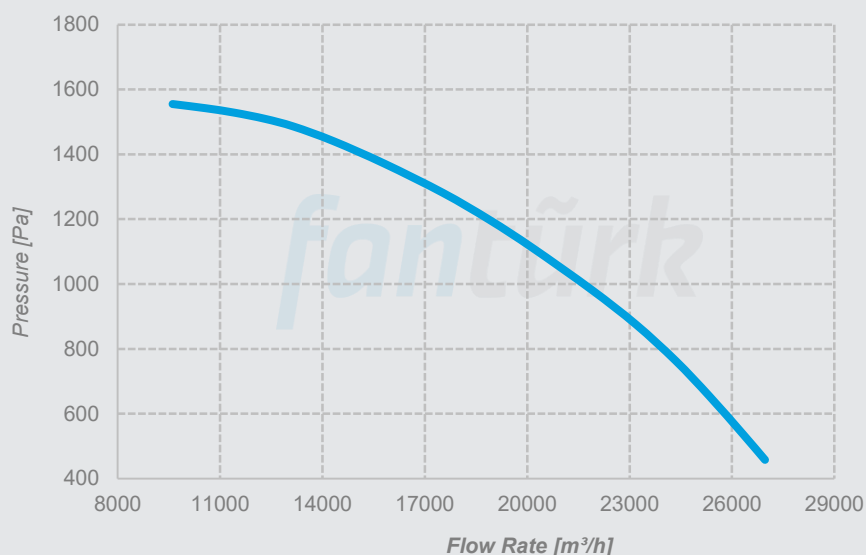

ABF 500/15

Voltage 380 V
Frequency 50 Hz
Motor Power 15 kW
Motor Speed 1460 rpm
Sound Pressure Level 79 dBA
Weight 300 kg

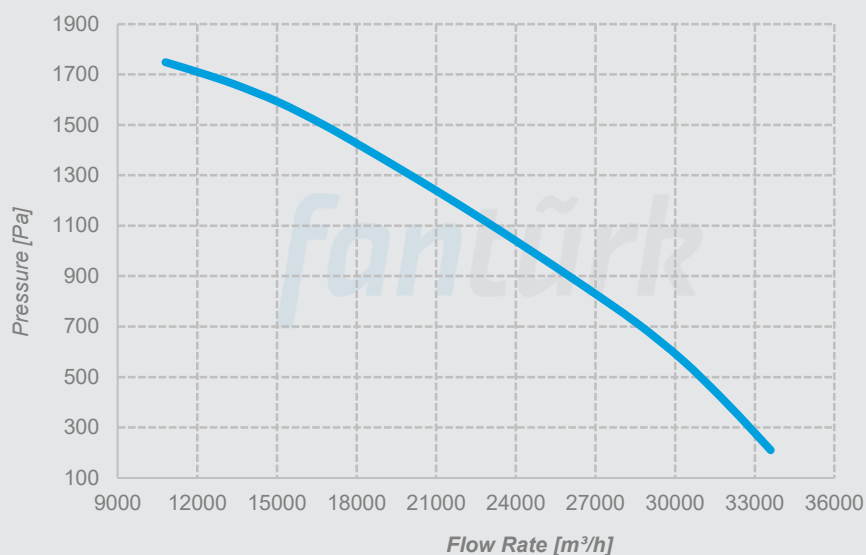

Performance Curves

ABF 560/5,5

Voltage 380 V
Frequency 50 Hz
Motor Power 5,5 kW
Motor Speed 950 rpm
Sound Pressure Level 74 dBA
Weight 360 kg

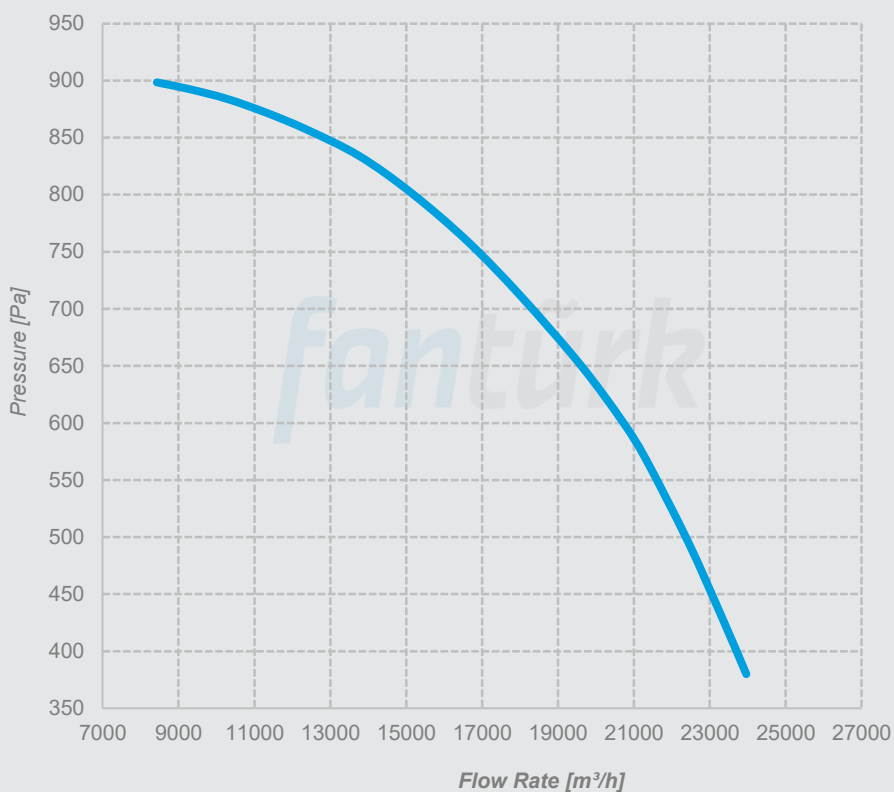

ABF 560/7,5

Voltage 380 V
Frequency 50 Hz
Motor Power 7,5 kW
Motor Speed 960 rpm
Sound Pressure Level 75 dBA
Weight 395 kg

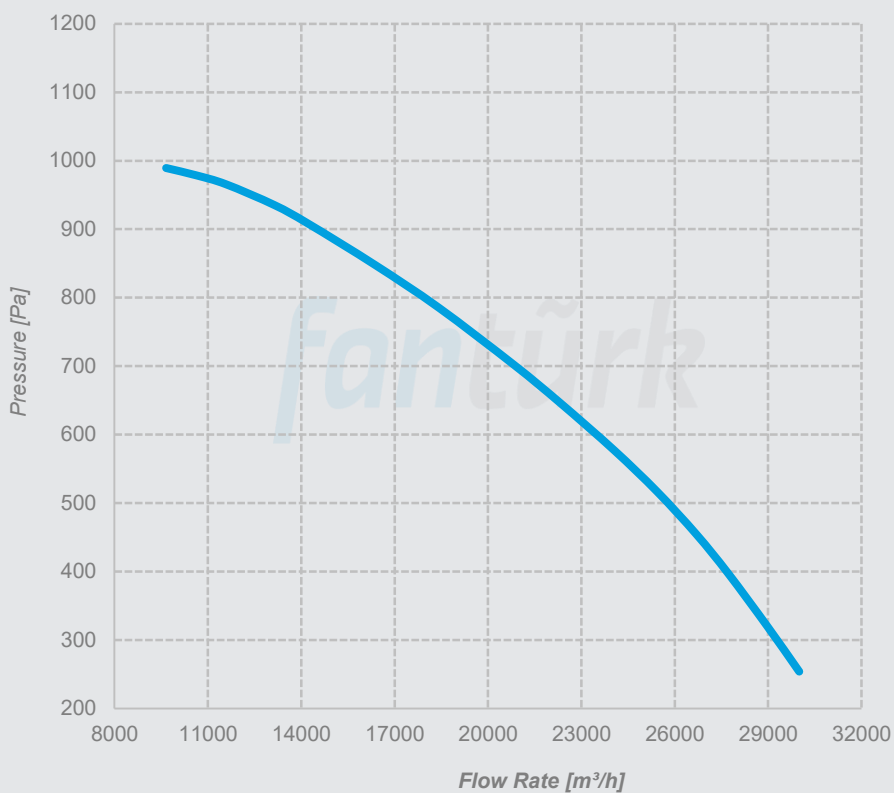

Performance Curves

ABF 560/18,5

Voltage 380 V
Frequency 50 Hz
Motor Power 18,5 kW
Motor Speed 1460 rpm
Sound Pressure Level 82 dBA
Weight 479 kg

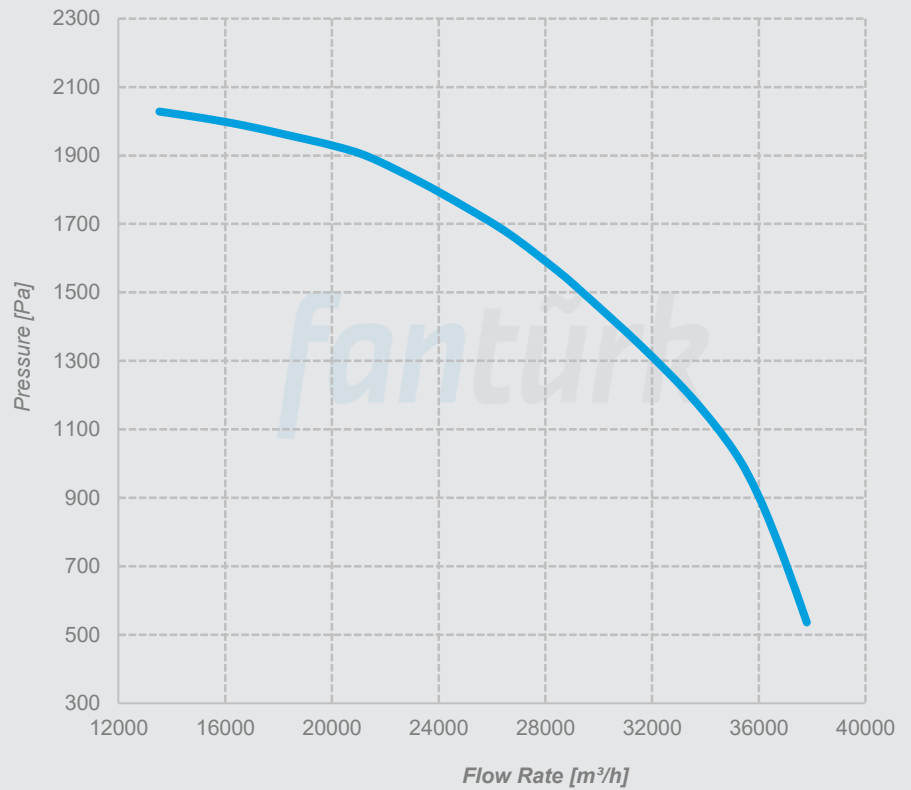

ABF 560/22

Voltage 380 V
Frequency 50 Hz
Motor Power 22 kW
Motor Speed 1460 rpm
Sound Pressure Level 83 dBA
Weight 490 kg

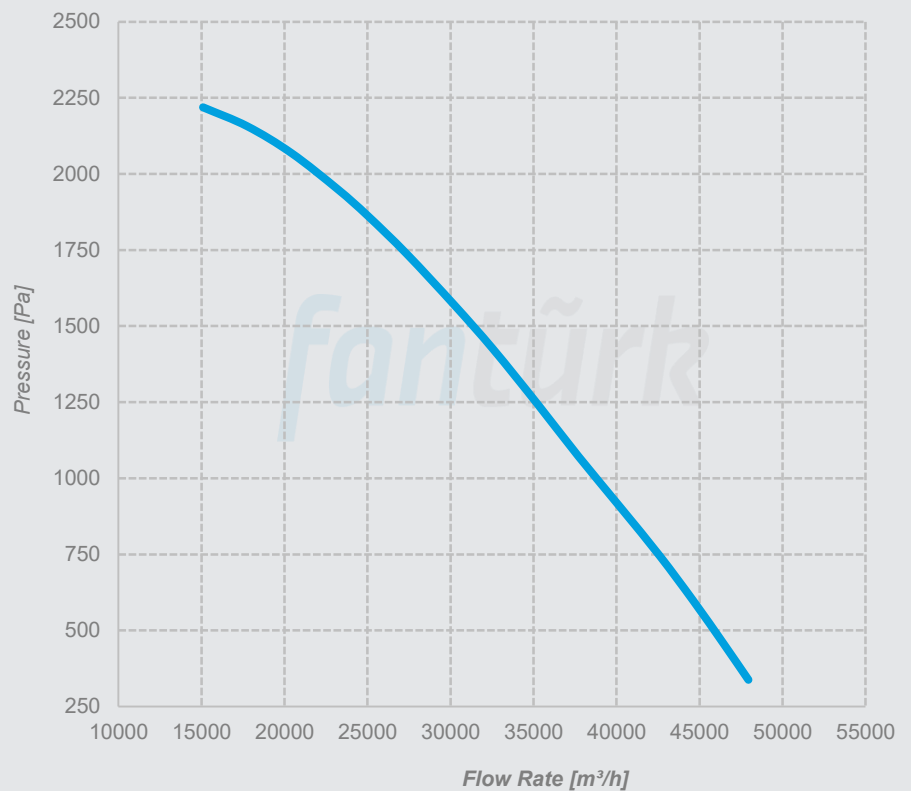

*Minarelicavus OSB District 202. Street No: 19 Nilüfer/Bursa Turkey
T: 90(224)482 50 95 E: info@fanturk.com.tr*

fanturk.com.tr