



## ***Product Catalogue***



fant



# fantürk

İKLİMLENDİRME SİSTEMLERİ

***Sensitive to customer's desires,  
pays special attention to quality  
and respectful to work ethics...***

*Our company's head offices are in the Bursa, the production site in Bilecik, has been operating under the title Havart İklimlendirme LLC. and brand name Fanturk since 2002. Fanturk addresses the sector with production of HVAC devices, automation system software and MCC-DCC panel manufacturing with our engineers and blue-collar employees who are experts in their branches, in 10000 m<sup>2</sup> closed area and 52000 m<sup>2</sup> open area.*

*In the light of our experience, our company, which is sensitive to customer expectations, prioritizes quality, and adopts respecting business ethics and ethical beliefs as its basic principle, has a vision that aims to develop and grow.*

*Fanturk is prioritizes R&D studies and always aims to increase the manufacturing capacity and product quality based on international standards.*

## ***Our Vision***

*Being a global leader company which producing technologies for humankind to breathe.*

## ***Our Mission***

*Provide innovative technologies for use of humankind.*

***fantürk***  
AIR CONDITIONING SYSTEMS

*makes you  
breathe !*



# Contents

<i>Y-KTF Round Duct Type In-Line Fan</i>	<b>6</b>
<i>D-KTF Rectangular Duct Type In-Line Fan</i>	<b>11</b>
<i>D-KTF External Driven Rectangular Duct Type In-Line Fan</i>	<b>16</b>
<i>D-KTF EX Ex-Proof External Driven Rectangular Duct Type In-Line Fan</i>	<b>21</b>
<i>ÇTF (230V) Roof Type Radial Fan</i>	<b>26</b>
<i>ÇTF (380V) External Driven Horizontal Flow Roof Type Fan</i>	<b>32</b>
<i>ÇTF (380V) External Driven Vertical Flow Roof Type Fan</i>	<b>37</b>
<i>Ç-FWA Roof Type Axial Fan</i>	<b>42</b>
<i>IGK Heat Recovery Unit</i>	<b>44</b>
<i>ECO Compact Cabinet Type Fan</i>	<b>54</b>
<i>M-HA Cabinet Type Kitchen Aspirator</i>	<b>60</b>
<i>FKS Air Handling Unit</i>	<b>65</b>
<i>HNS Pool Dehumidification Unit</i>	<b>76</b>
<i>FRTT Rooftop Air Handling Unit</i>	<b>84</b>
<i>F-EVAP Evaporative Cooling Unit</i>	<b>89</b>
<i>J-FWA Axial Jet Fan</i>	<b>95</b>
<i>R-FWA Radial Jet Fan</i>	<b>98</b>
<i>P-FWA Axial Fan</i>	<b>102</b>
<i>Y-FWA Axial Smoke Exhaust Fan</i>	<b>104</b>
<i>H-FWA Cabinet Type Axial Fan</i>	<b>106</b>
<i>Performance Curves of Devices with Axial Fan</i>	<b>108</b>
<i>D-FWA Wall Mounted Axial Fan</i>	<b>135</b>
<i>T-FWA Tunnel Jet Fan</i>	<b>139</b>
<i>M-FWA Mining Ventilation Fan</i>	<b>143</b>
<i>ABF Low Pressure Centrifugal Fan</i>	<b>145</b>
<i>OBF Medium Pressure Centrifugal Fan</i>	<b>159</b>
<i>R-APA Radial Unit Heater</i>	<b>165</b>
<i>A-APA Axial Unit Heater</i>	<b>167</b>
<i>Industrial Air Curtain</i>	<b>169</b>
<i>Dust Collection System</i>	<b>170</b>
<i>Certificates</i>	<b>171</b>



# Y-KTF Round Duct Type In- Line Fan



## Technical Specifications

# ROUND DUCT TYPE IN-LINE FAN

Y-KTF series round duct type in-line fans are the ideal fans for ducted ventilation systems which requires high flow rate and high pressure loss. Thanks to their compact construction, they can be installed directly in the air ducts without the need for large bends and transducers in any position required. Y-KTF series in-line fans are the ideal choice for high performance and trouble-free operation.

Body is manufacturing from high quality galvanized sheet. Fans are radial fans with backward curved blades. Motors are single phase and has IP55 and Class F insulation. Speed controller is optional for all models.

### Usage Areas

Can be used in all kinds of ventilation systems for Industry Buildings, Offices, Residential Buildings, Shopping Malls.

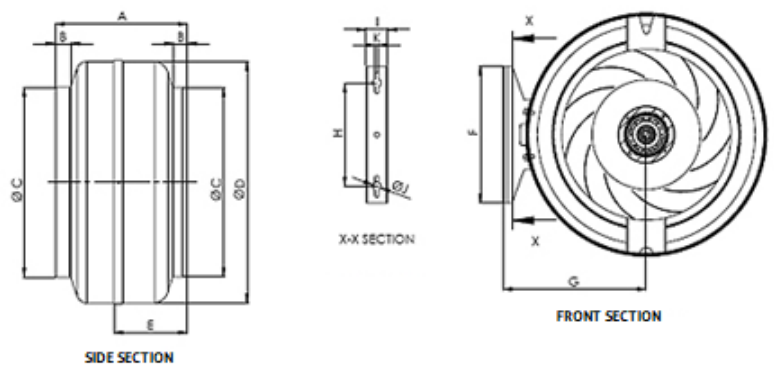
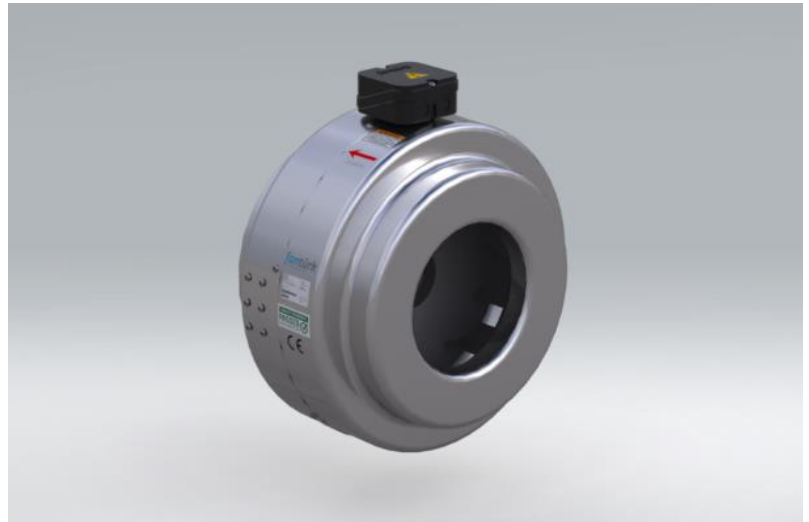

MODEL	A	B	C	D	E	F	G	H	I	J	K	VOLTAGE	FREQUENCY	POWER	CURRENT	CAPACITOR	MOTOR SPEED	AIR FLOW RATE	SOUND P. LEVEL	WEIGHT
	mm	mm	mm	mm	mm	mm	mm	mm	mm	mm	mm	V	Hz	W	A	µf	rpm	m <sup>3</sup> /h	dBA	kg
Y-KTF 100	210	26	98	233	124	225	157	170	35,5	14	6,5	230	50	68	0,28	2,5	2400	400	42	2,6
Y-KTF 125	203	26	123	233	110	225	157	170	35,5	14	6,5	230	50	76	0,29	2,5	2350	500	43	2,7
Y-KTF 150	230	30	149	322	125	225	200	170	35,5	14	6,5	230	50	110	0,47	3	1530	650	47	3,5
Y-KTF 200	228	30	199	342	130	225	210,5	170	35,5	14	6,5	230	50	160	0,68	4	2600	1000	52	5
Y-KTF 250	227	30	248	342	130	225	210,5	170	35,5	14	6,5	230	50	180	0,8	4	2700	1200	57	5,5
Y-KTF 315	220	26	311	397	122	225	238	170	35,5	14	6,5	230	50	285	1,5	5	2500	2000	68	6,9

## Performance Curves

### Y-KTF 100

Voltage 230 V  
Frequency 50 Hz  
Power 68 W  
Current 0,28 A  
Capacitor 2,5  $\mu$ f  
Speed 2400 rpm  
Air Flow Rate 400 m<sup>3</sup>/h  
Sound Pressure Level 42 dBA  
Weight 2,6 kg

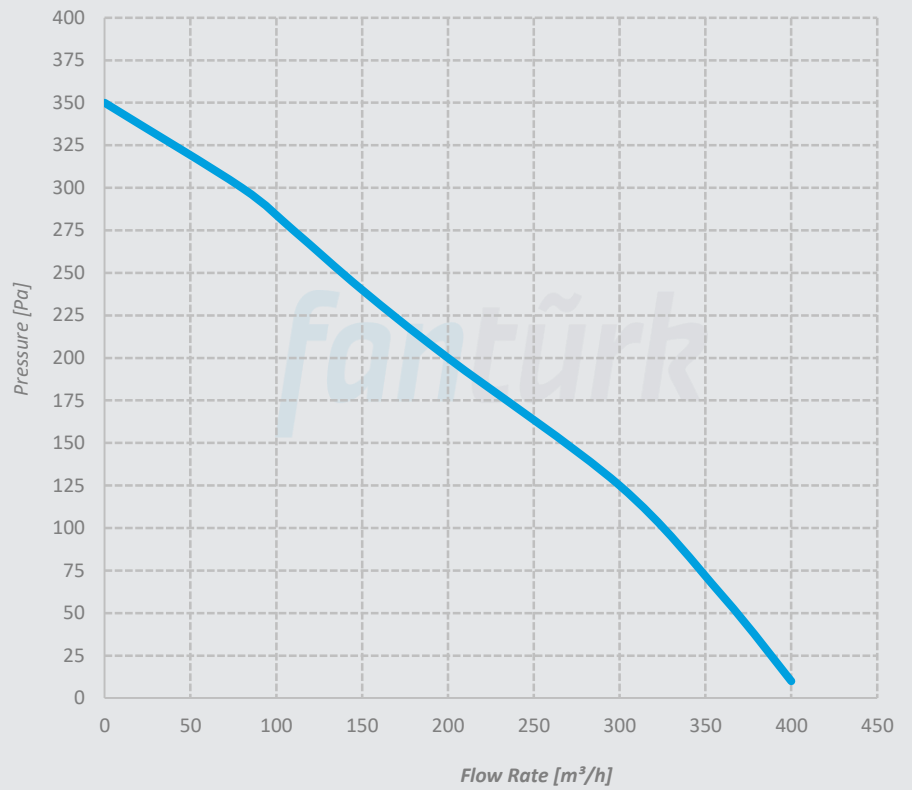

### Y-KTF 125

Voltage 230 V  
Frequency 50 Hz  
Power 76 W  
Current 0,29 A  
Capacitor 2,5  $\mu$ f  
Speed 2350 rpm  
Air Flow Rate 500 m<sup>3</sup>/h  
Sound Pressure Level 43 dBA  
Weight 2,7 kg

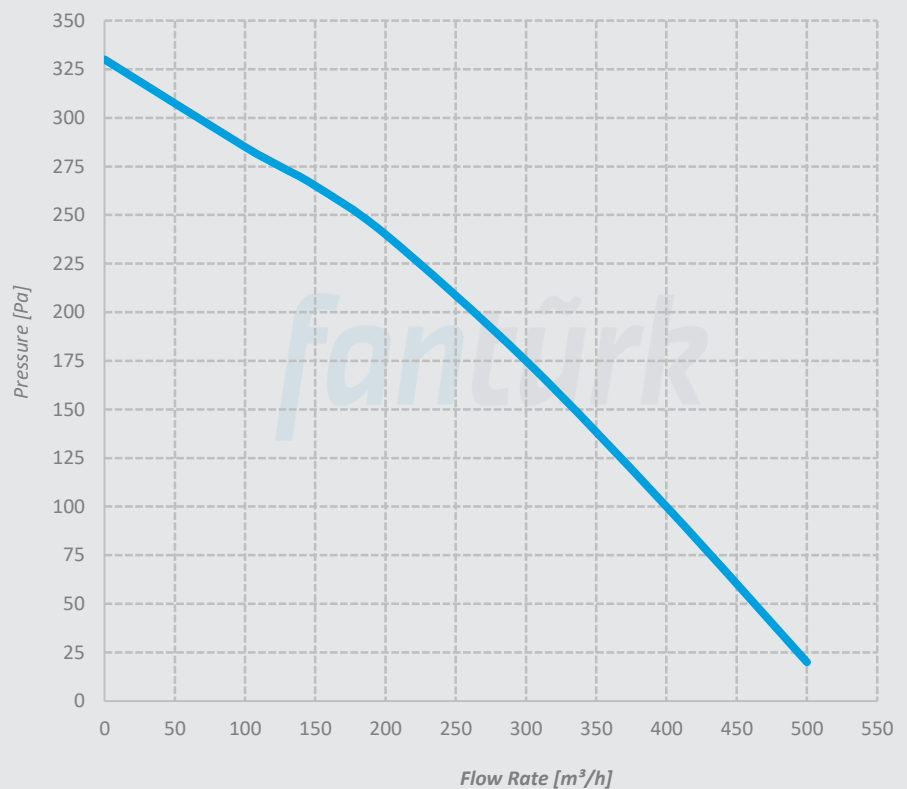



## Performance Curves

### Y-KTF 150

Voltage 230 V  
Frequency 50 Hz  
Power 110 W  
Current 0,47 A  
Capacitor 3  $\mu$ f  
Speed 1530 rpm  
Air Flow Rate 650 m<sup>3</sup>/h  
Sound Pressure Level 47 dBA  
Weight 3,5 kg

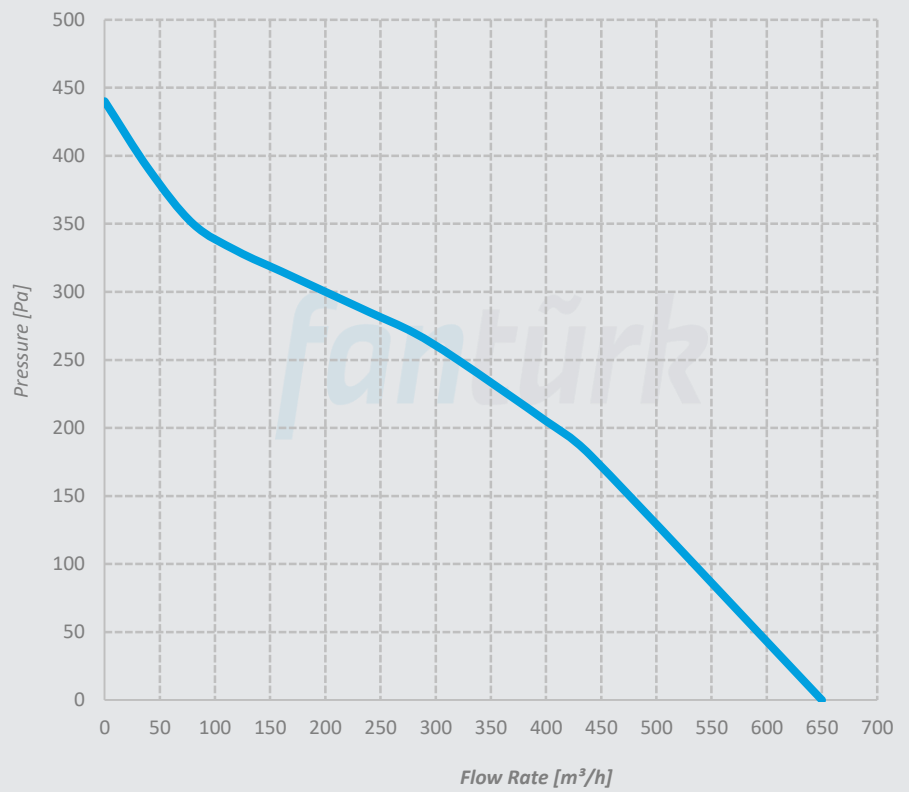

### Y-KTF 200

Voltage 230 V  
Frequency 50 Hz  
Power 160 W  
Current 0,68 A  
Capacitor 4  $\mu$ f  
Speed 2600 rpm  
Air Flow Rate 1000 m<sup>3</sup>/h  
Sound Pressure Level 52 dBA  
Weight 5 kg

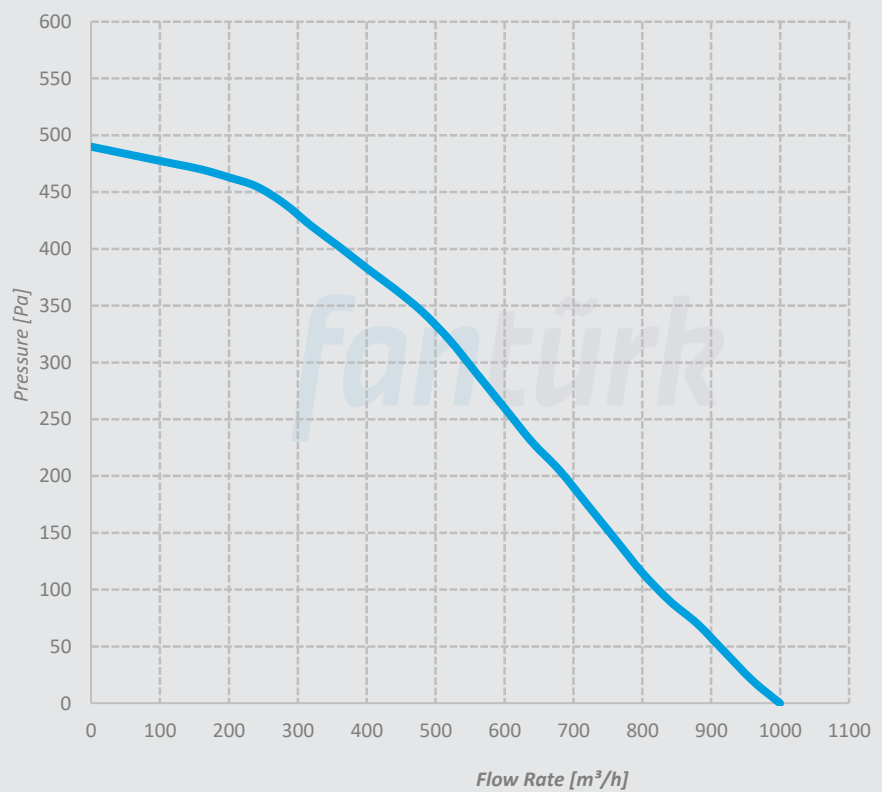

## Performance Curves

### Y-KTF 250

Voltage 230 V  
Frequency 50 Hz  
Power 180 W  
Current 0,8 A  
Capacitor 4  $\mu$ f  
Speed 2700 rpm  
Air Flow Rate 1200 m<sup>3</sup>/h  
Sound Pressure Level 57 dBA  
Weight 5,5 kg

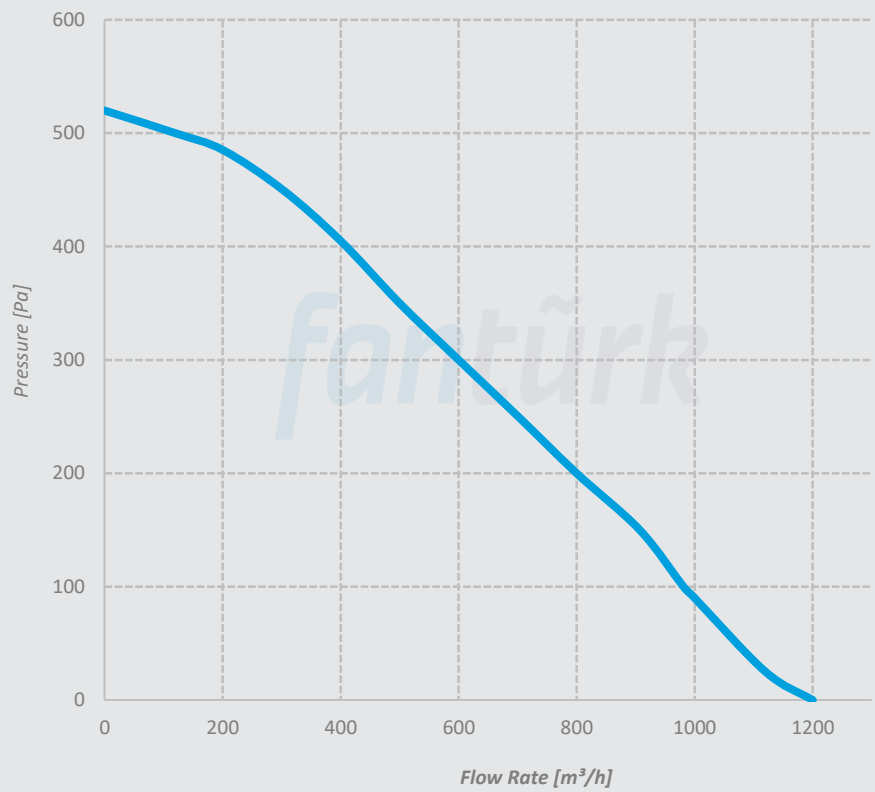

### Y-KTF 315

Voltage 230 V  
Frequency 50 Hz  
Power 285 W  
Current 1,5 A  
Capacitor 5  $\mu$ f  
Speed 2500 rpm  
Air Flow Rate 2000 m<sup>3</sup>/h  
Sound Pressure Level 68 dBA  
Weight 6,9 kg

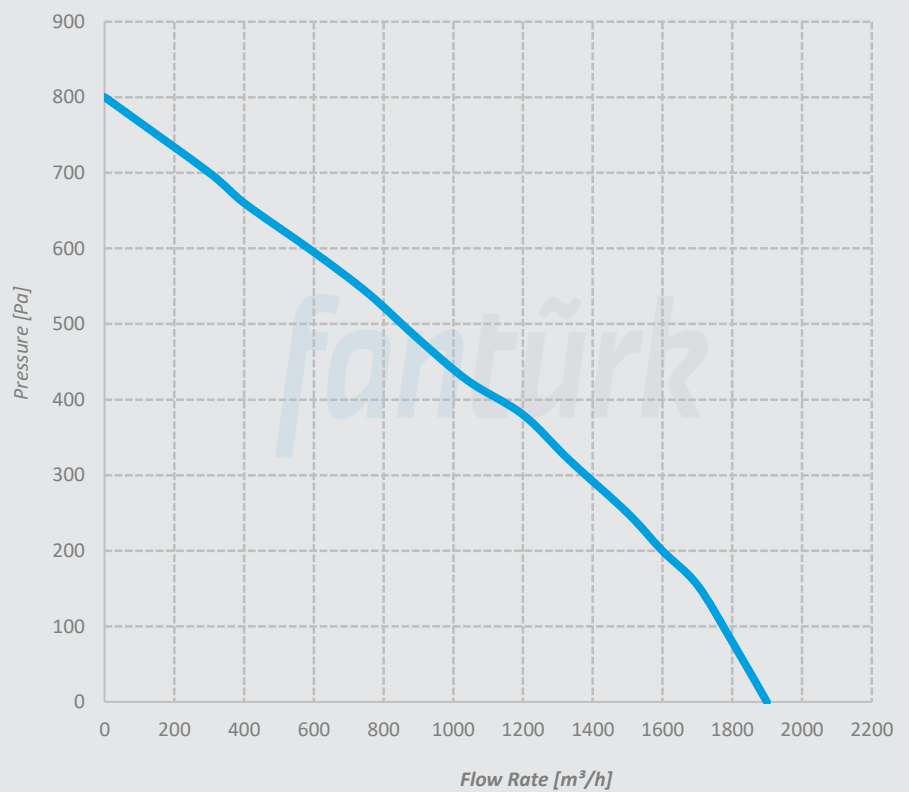



**D-KTF**  
**Rectangular Duct**  
**Type In-Line Fan**

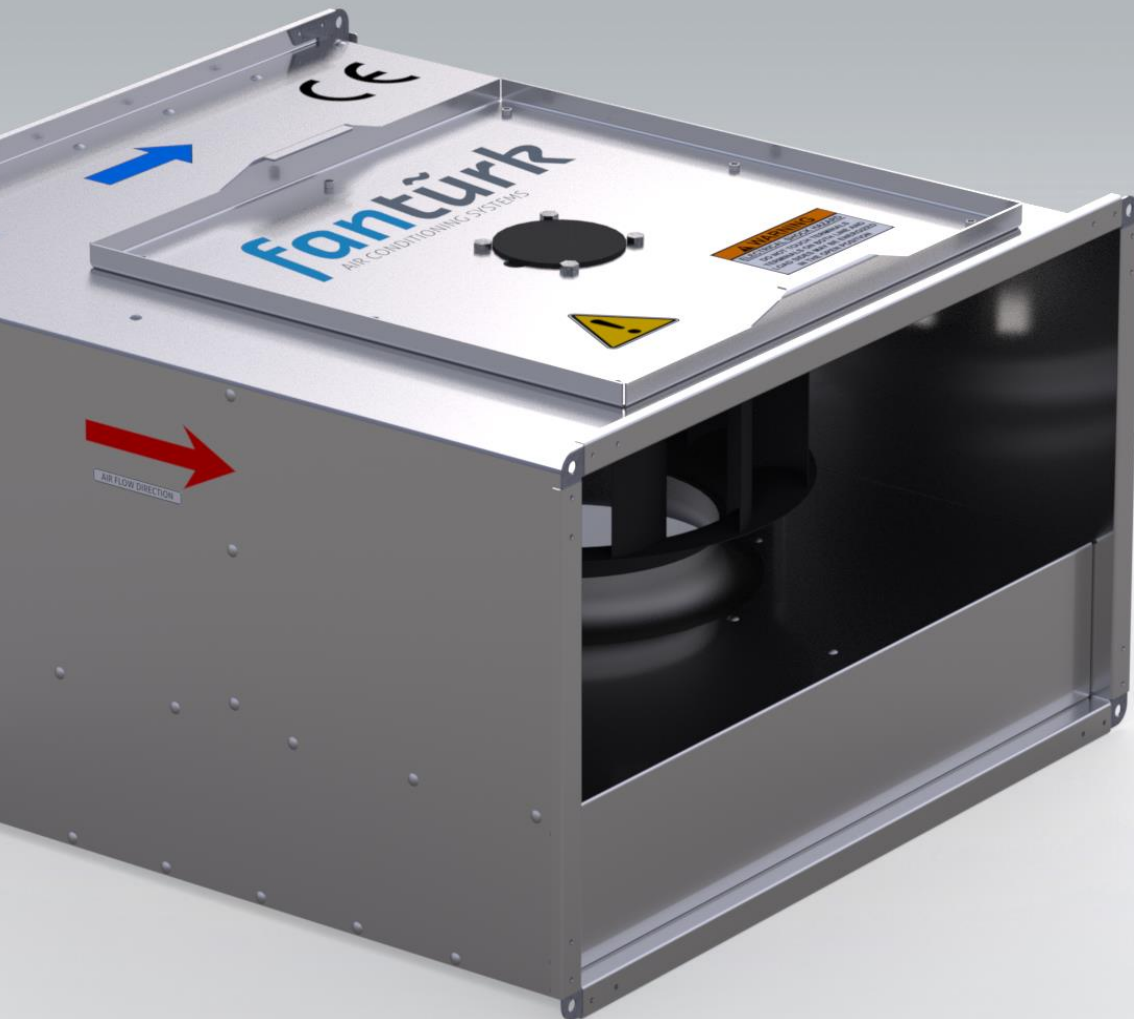

## Technical Specifications

# RECTANGULAR DUCT TYPE IN-LINE FAN

D-KTF series rectangular duct type radial fans; They are the ideal fans for ducted ventilation systems where high air flow and high pressure are required. Thanks to their compact construction, they can be installed directly in the air ducts without the need for large bends and transducers in any position required. D-KTF series in-line fans are the ideal choice for high performance and trouble-free operation.

Made of high quality corrosion resistant galvanized steel. Fans are radial fans with backward curved blades. Thanks to the service cover, the fan can carry out maintenance without removing the duct connection. Motors are single phase and has IP55 and Class F insulation. Speed controller is optional for all models.

### Usage Areas

Can be used for ventilation systems in industrial buildings, kitchens, toilets, swimming pools, gyms, warehouses, hospitals, offices, laboratories, shopping malls, restaurants, theaters, residential buildings.

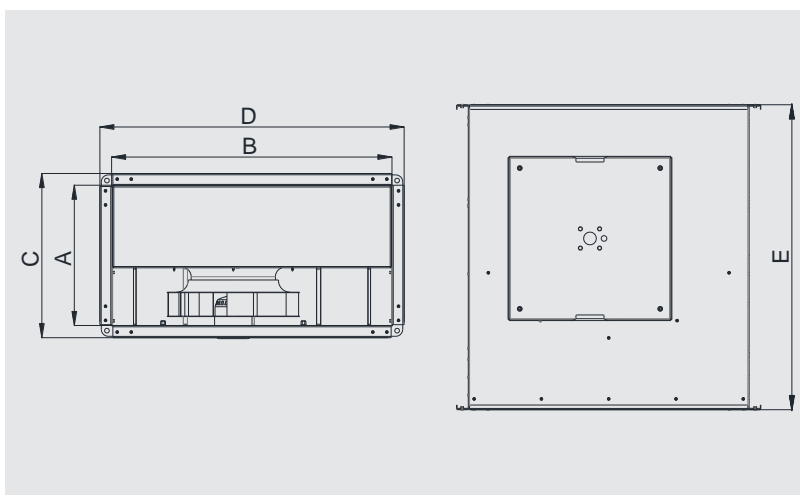

MODEL	A	B	C	D	E	VOLTAGE	FREQUENCY	MOTOR POWER	CURRENT	CAPACITOR	MOTOR SPEED	AIR FLOW RATE	SOUND PREEURE LEVEL	WEIGHT
	mm	mm	mm	mm	mm	V	Hz	W	A	μF	rpm	m³/h	dBA	kg
D-KTF 30 - 15	150	300	200	350	400	230	50	76	0,29	2,5	2350	540	52	7
D-KTF 40 - 20	200	400	250	450	500	230	50	160	0,68	4	2600	1150	63	12
D-KTF 50 - 25	250	500	300	550	550	230	50	180	0,8	4	2700	1520	58	16
D-KTF 60 - 30	300	600	350	650	650	230	50	285	1,5	5	2500	2110	70	20
D-KTF 60 - 35	350	600	400	650	750	230	50	272	1,23	8	1364	3150	66	27
D-KTF 70 - 40	400	700	450	750	800	230	50	500	1,8	12	1380	4400	63	38
D-KTF 80 - 50	500	800	550	850	900	230	50	800	3,7	16	1359	6000	70	61
D-KTF 100 - 50	500	1000	550	1050	1050	230	50	1550	6,8	31	1380	8200	73	86

## Performance Curves

### D-KTF 30 - 15

Voltage 230 V  
Frequency 50 Hz  
Motor Power 76 W  
Current 0,29 A  
Capacitor 2,5  $\mu$ f  
Motor Speed 2350 rpm  
Flow Rate 540 m<sup>3</sup>/h  
Sound Pressure Level 52 dBA  
Weight 7 kg

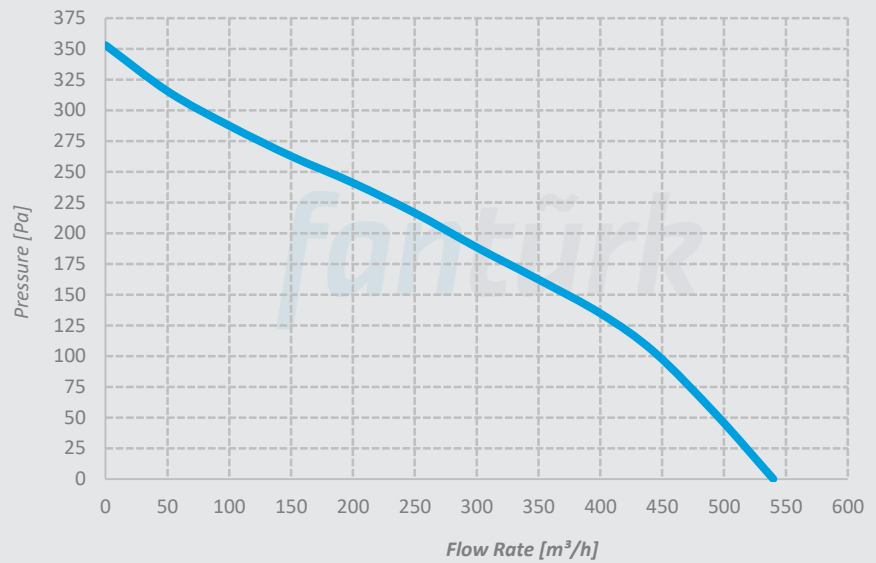

### D-KTF 40 - 20

Voltage 230 V  
Frequency 50 Hz  
Motor Power 160 W  
Current 0,68 A  
Capacitor 4  $\mu$ f  
Motor Speed 2600 rpm  
Flow Rate 1150 m<sup>3</sup>/h  
Sound Pressure Level 63 dBA  
Weight 12 kg

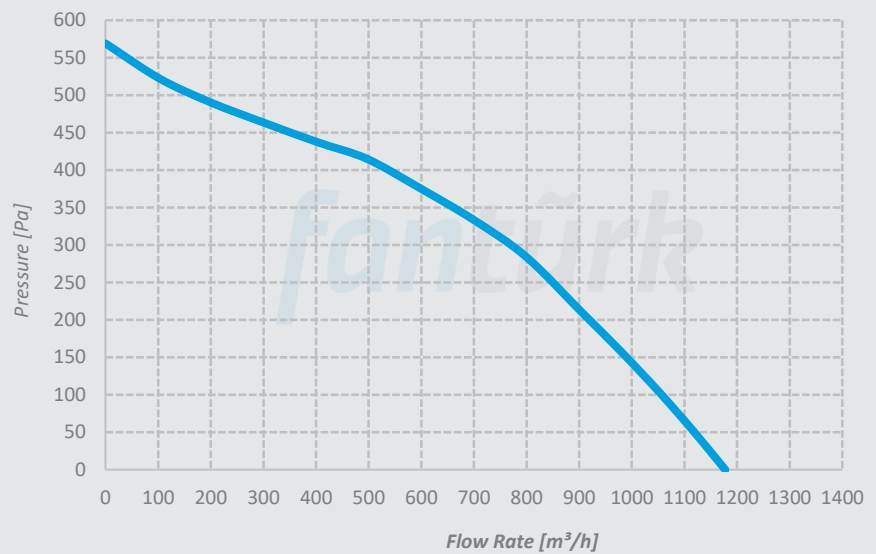

### D-KTF 50 - 25

Voltage 230 V  
Frequency 50 Hz  
Motor Power 180 W  
Current 0,8 A  
Capacitor 4  $\mu$ f  
Motor Speed 2700 rpm  
Flow Rate 1520 m<sup>3</sup>/h  
Sound Pressure Level 58 dBA  
Weight 16 kg

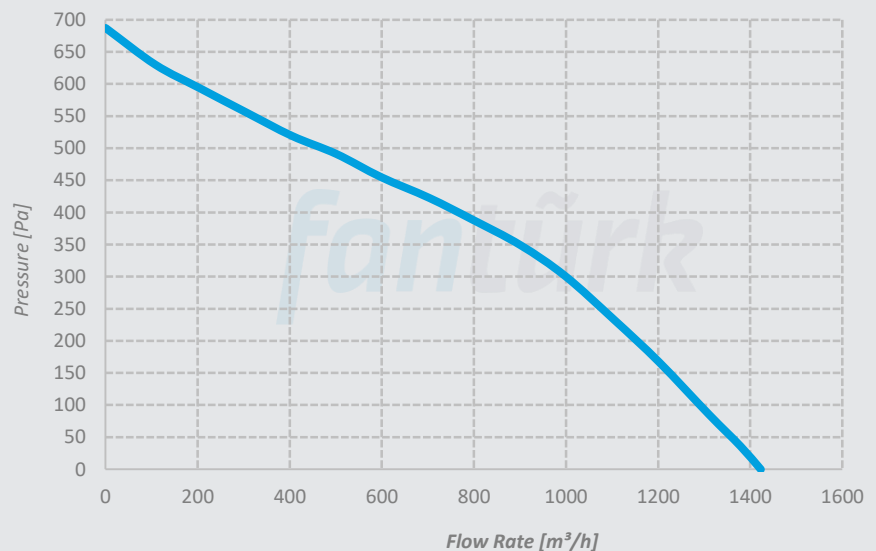

## Performance Curves

### D-KTF 60 - 30

Voltage 230 V  
Frequency 50 Hz  
Motor Power 285 W  
Current 1,5 A  
Capacitor 5  $\mu$ f  
Motor Speed 2500 rpm  
Flow Rate 2110 m<sup>3</sup>/h  
Sound Pressure Level 70 dBA  
Weight 20 kg

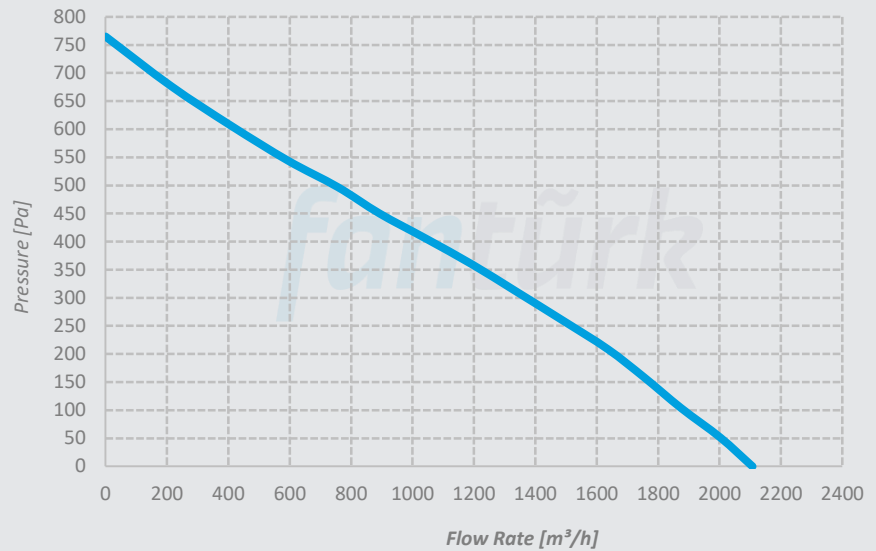

### D-KTF 60 - 35

Voltage 230 V  
Frequency 50 Hz  
Motor Power 272 W  
Current 1,23 A  
Capacitor 8  $\mu$ f  
Motor Speed 1364 rpm  
Flow Rate 3150 m<sup>3</sup>/h  
Sound Pressure Level 66 dBA  
Weight 27 kg

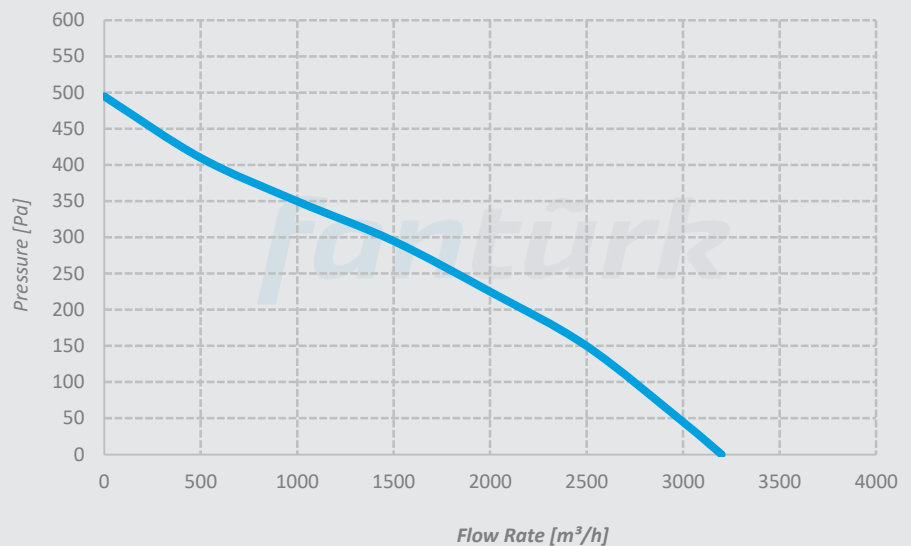

### D-KTF 70 - 40

Voltage 230 V  
Frequency 50 Hz  
Motor Power 500 W  
Current 1,8 A  
Capacitor 12  $\mu$ f  
Motor Speed 1380 rpm  
Flow Rate 4400 m<sup>3</sup>/h  
Sound Pressure Level 63 dBA  
Weight 38 kg

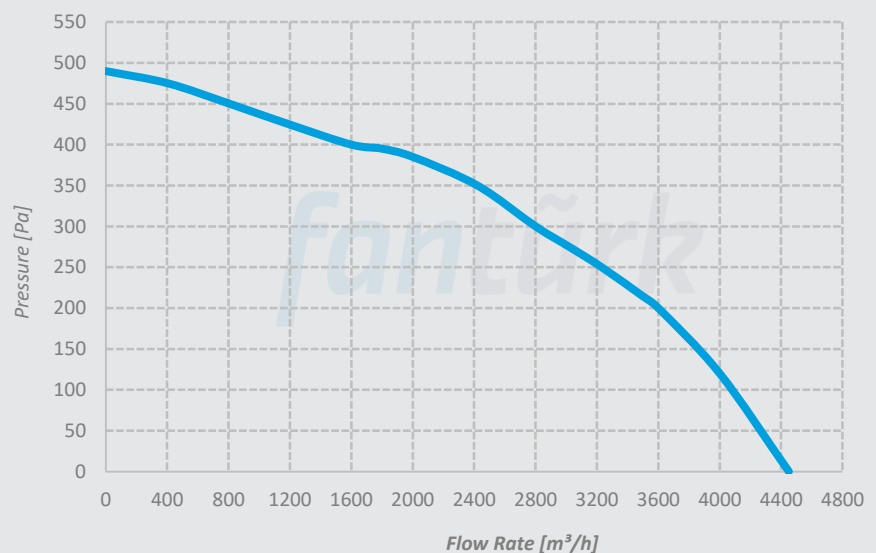

## Performance Curves

### D-KTF 80 - 50

Voltage 230 V  
Frequency 50 Hz  
Motor Power 800 W  
Current 3,7 A  
Capacitor 16  $\mu$ f  
Motor Speed 1359 rpm  
Flow Rate 6000 m<sup>3</sup>/h  
Sound Pressure Level 70 dBA  
Weight 61 kg

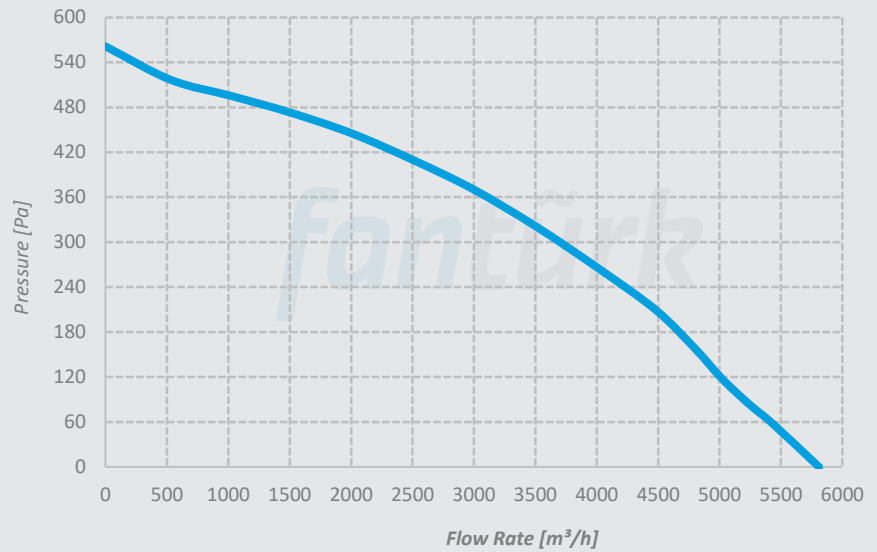

### D-KTF 100 - 50

Voltage 230/380 V  
Frequency 50 Hz  
Motor Power 1550W  
Current 6,8 A  
Capacitor 31  $\mu$ f  
Motor Speed 1380rpm  
Flow Rate 8200 m<sup>3</sup>/h  
Sound Pressure Level 73 dBA  
Weight 86 kg

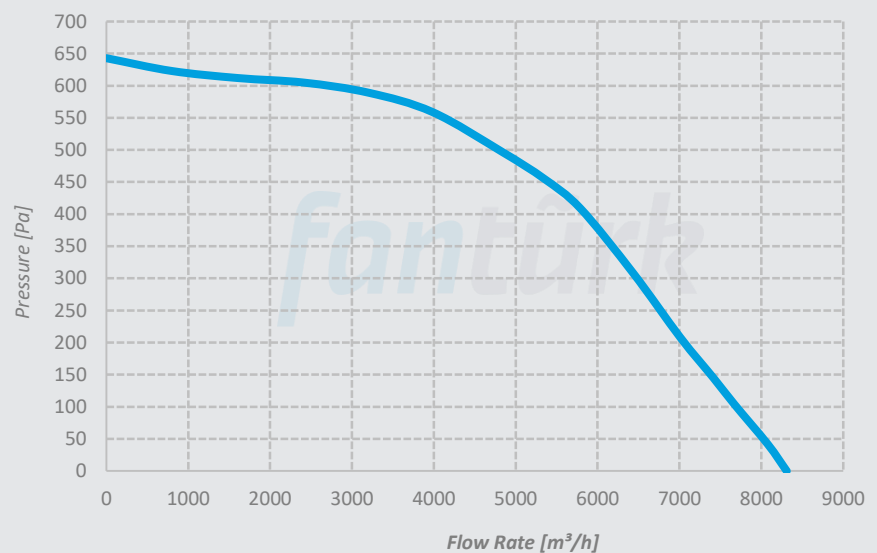



*D-KTF  
External Driven  
Rectangular Duct  
Type In-Line Fan*

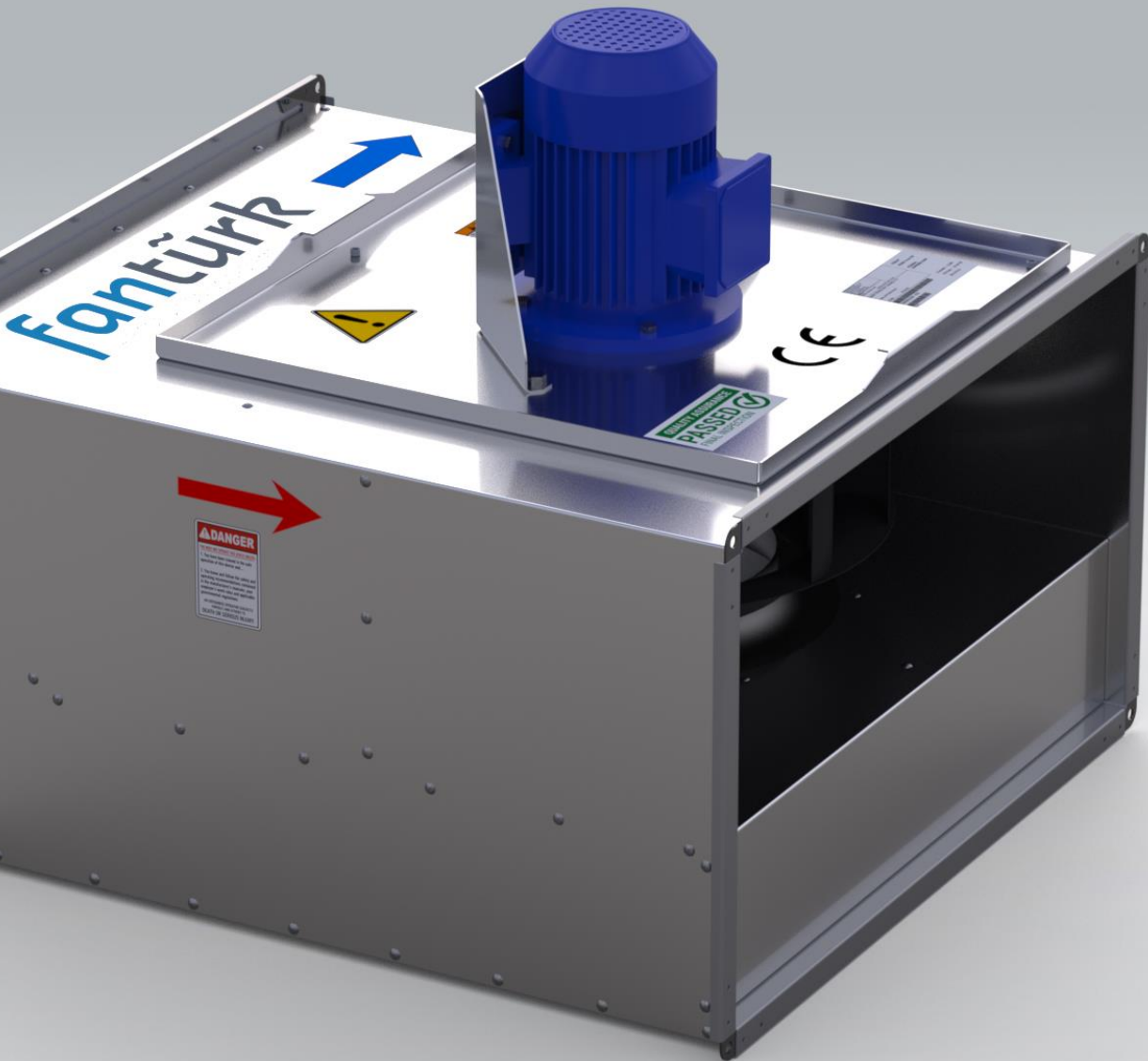



## Technical Specifications

# RECTANGULAR DUCT TYPE IN-LINE FAN

D-KTF series rectangular duct type radial fans; They are the ideal fans for ducted ventilation systems where high air flow and high pressure are required. Thanks to their compact construction, they can be installed directly in the air ducts without the need for large bends and transducers in any position required. D-KTF series in-line fans are the ideal choice for high performance and trouble-free operation.

Made of high quality corrosion resistant galvanized steel. Fans are radial fans with backward curved blades. Due to the fact that the motor is out of the air flow, it is protected from the factors that will damage the motor or hot air. This method provides 120 ° C continuous operation. Thanks to the service cover, the fan can be carry out maintenance without removing the duct connection. Motors are single phase and has IP55 and Class F insulation. Speed controller is optional for all models.

### Usage Areas

Can be used for ventilation systems in industrial buildings, kitchens, toilets, swimming pools, gyms, warehouses, hospitals, offices, laboratories, shopping malls, restaurants, theaters, residential buildings.

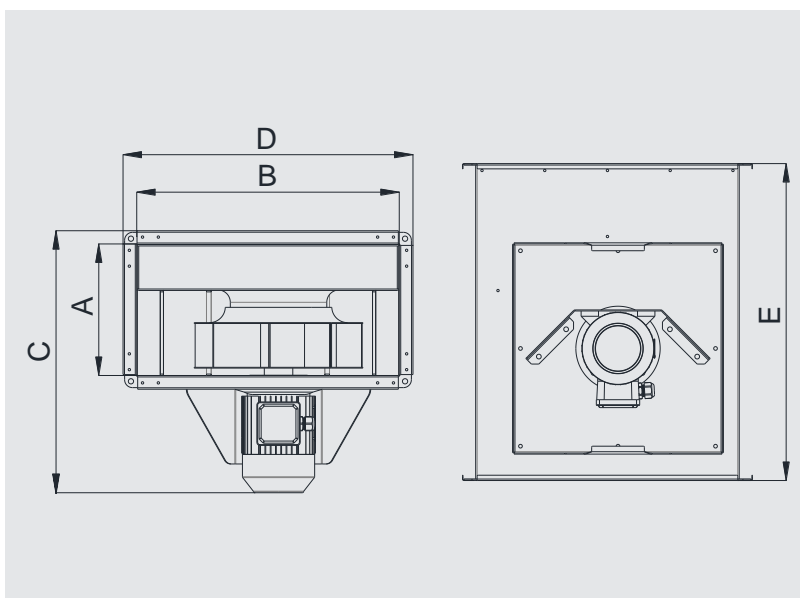
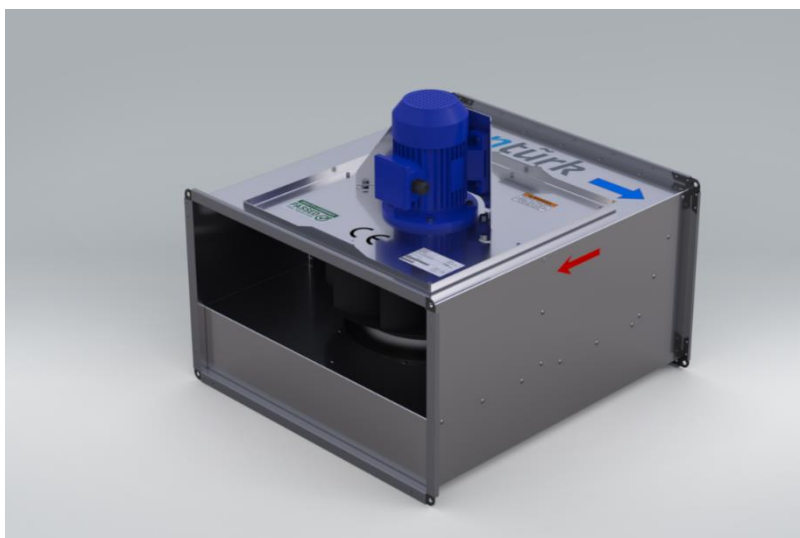

MODEL	A	B	C	D	E	VOLTAGE	FREQUENCY	POWER	CURRENT	MOTOR SPEED	AIR FLOW RATE	SOUND LEVEL	WEIGHT
	mm	mm	mm	mm	mm	V	Hz	kW	A	rpm	m <sup>3</sup> /h	dBa	kg
D-KTF 280	250	500	469	550	650	380	50	0,18	0,6	1340	1150	48	28
D-KTF 315	250	500	495	550	600	380	50	0,25	0,8	1380	2000	53	32
D-KTF 355	300	600	545	650	750	380	50	0,37	1,2	1390	2500	55	34
D-KTF 400	400	700	665	750	800	380	50	0,55	1,6	1385	3500	56	38
D-KTF 450	400	700	745	750	800	380	50	0,75	2	1370	5000	58	49
D-KTF 500	500	800	785	850	900	380	50	1,1	2,6	1380	7000	61	63
D-KTF 560	500	1000	810	1050	1050	380	50	1,5	3,5	1385	9800	64	74

## Performance Curves

### D-KTF 280

Voltage 380 V  
Frequency 50 Hz  
Motor Power 0,18 kW  
Motor Speed 1340 rpm  
Sound Pressure Level 48 dBA  
Weight 28 kg

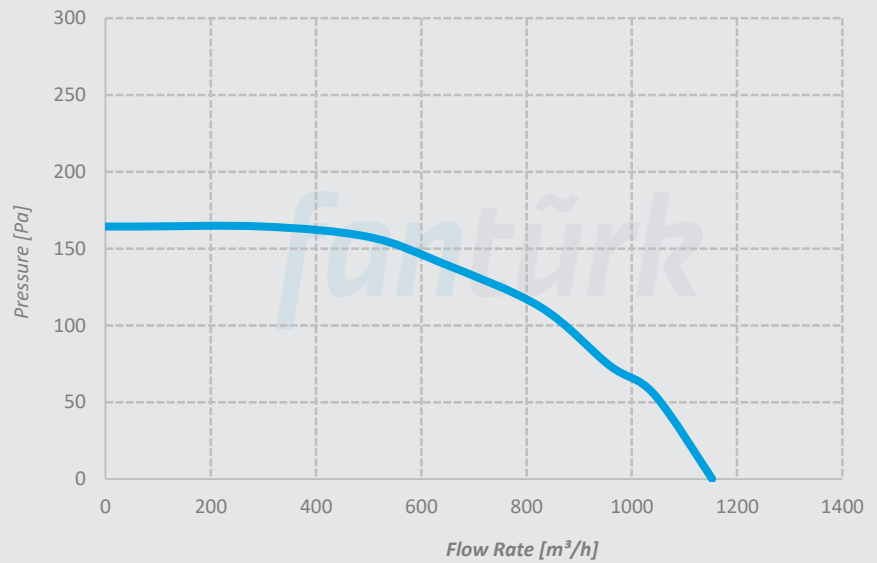

### D-KTF 315

Voltage 380 V  
Frequency 50 Hz  
Motor Power 0,25 kW  
Motor Speed 1380 rpm  
Sound Pressure Level 53 dBA  
Weight 32 kg

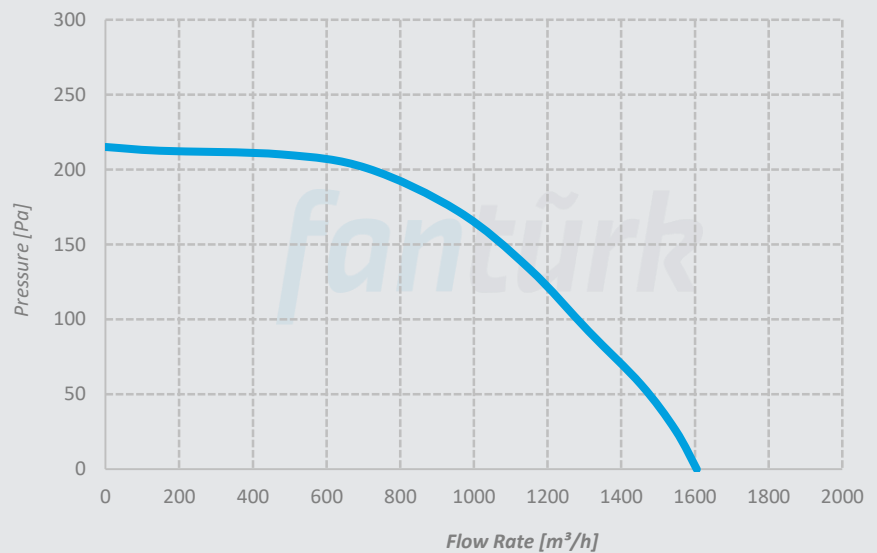

### D-KTF 355

Voltage 380 V  
Frequency 50 Hz  
Motor Power 0,37 kW  
Motor Speed 1390 rpm  
Sound Pressure Level 55 dBA  
Weight 34 kg

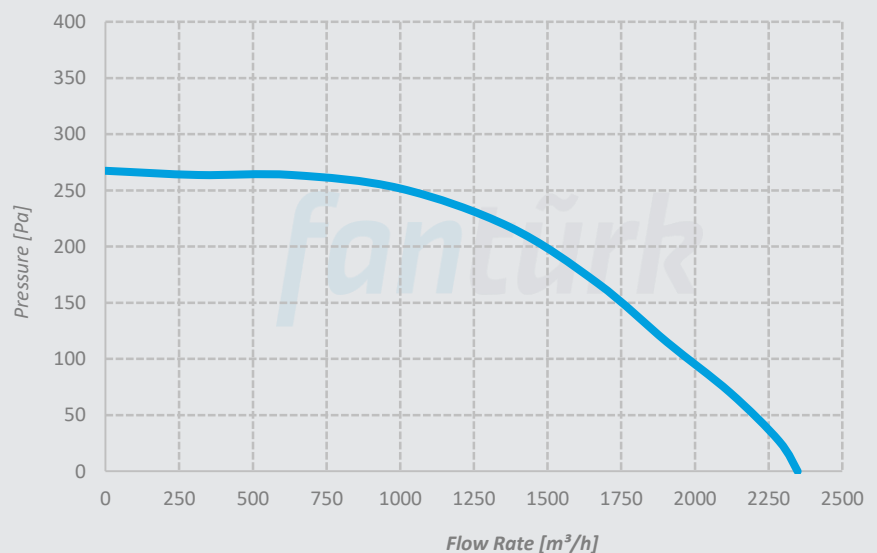

## Performance Curves

### D-KTF 400

Voltage 380 V  
Frequency 50 Hz  
Motor Power 0,55 kW  
Motor Speed 1385 rpm  
Sound Pressure Level 56 dBA  
Weight 38 kg

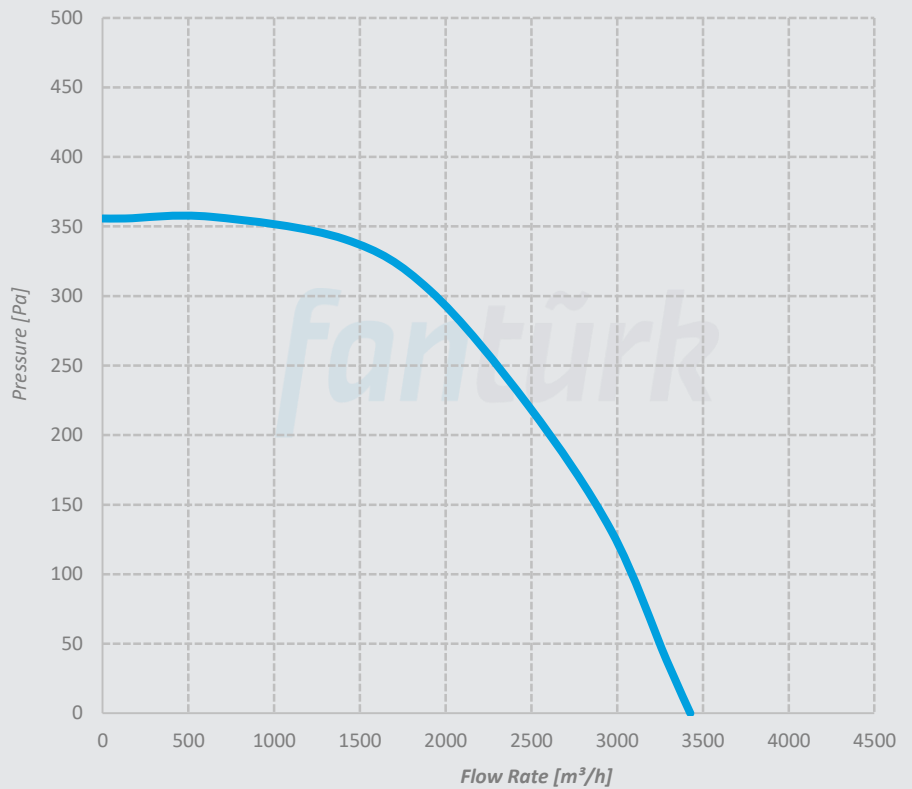

### D-KTF 450

Voltage 380 V  
Frequency 50 Hz  
Motor Power 0,75 kW  
Motor Speed 1370 rpm  
Sound Pressure Level 58 dBA  
Weight 49 kg

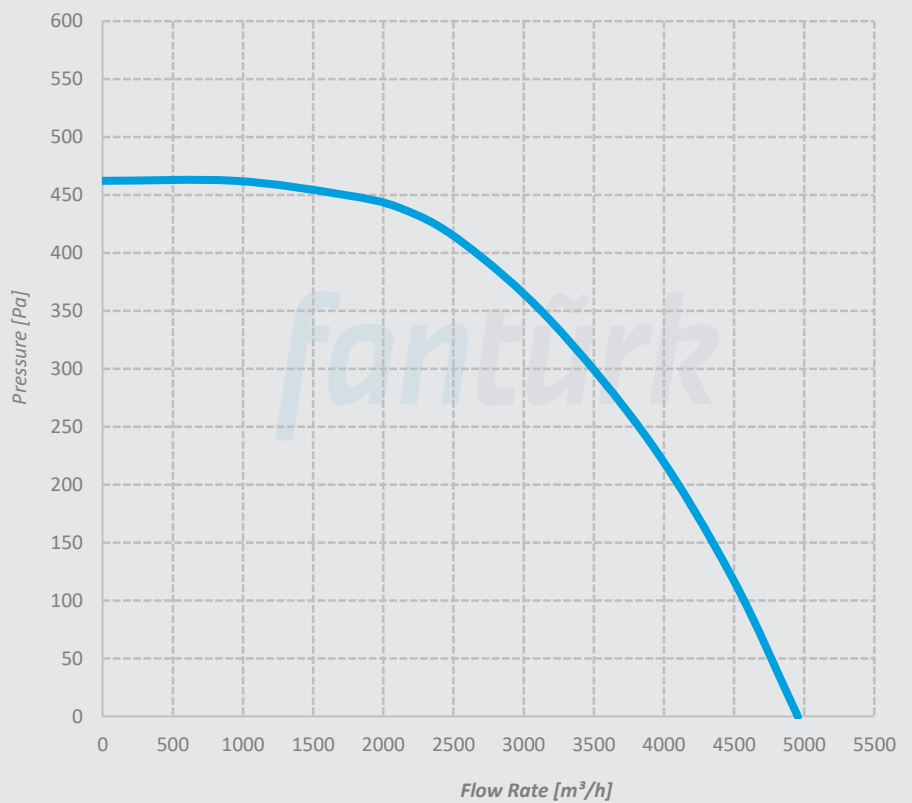

## Performance Curves

### D-KTF 500

Voltage 380 V  
Frequency 50 Hz  
Motor Power 1,1 kW  
Motor Speed 1380 rpm  
Sound Pressure Level 61 dBA  
Weight 63 kg

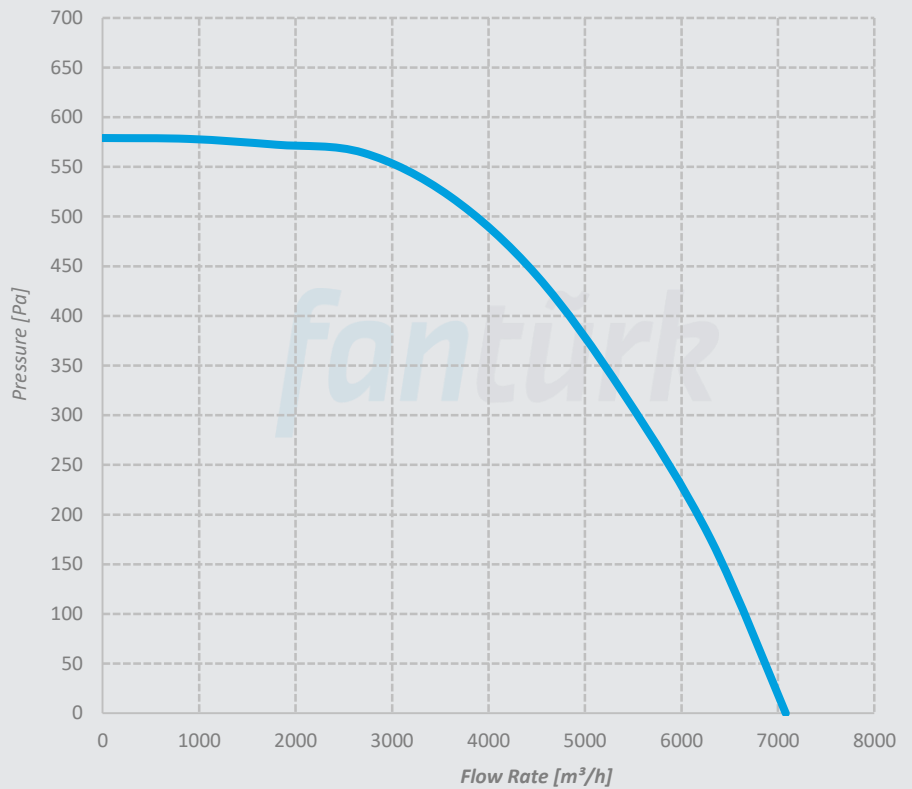

### D-KTF 560

Voltage 380 V  
Frequency 50 Hz  
Motor Power 1,5 kW  
Motor Speed 1385 rpm  
Sound Pressure Level 64 dBA  
Weight 74 kg

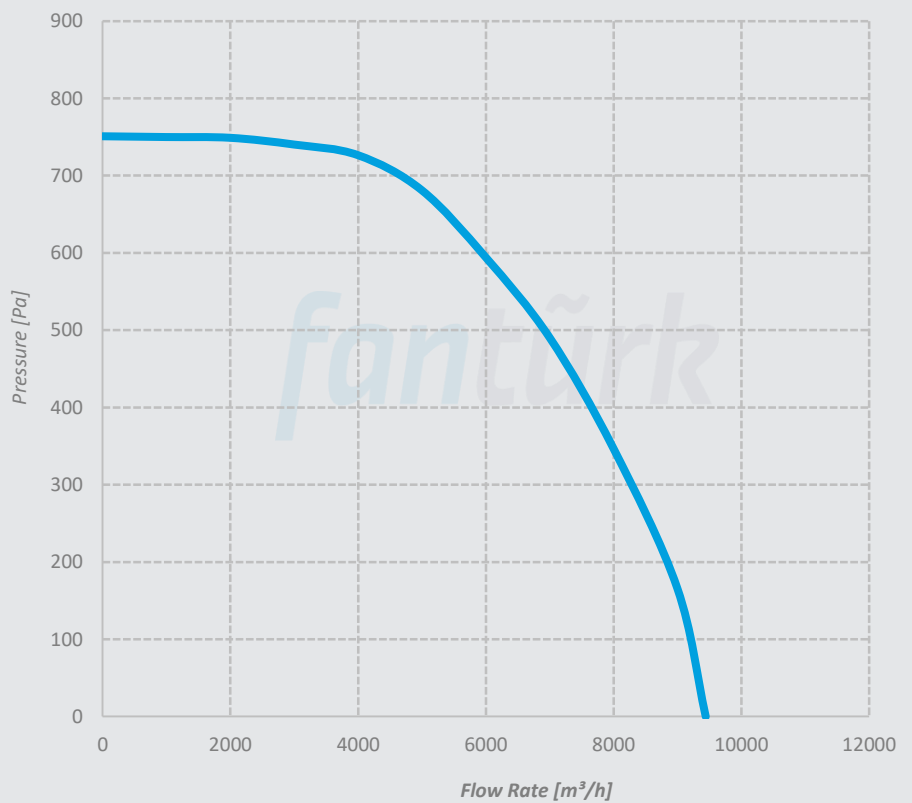



*D-KTF EX  
Ex-Proof External  
Driven  
Rectangular  
Duct Type In-Line Fan*

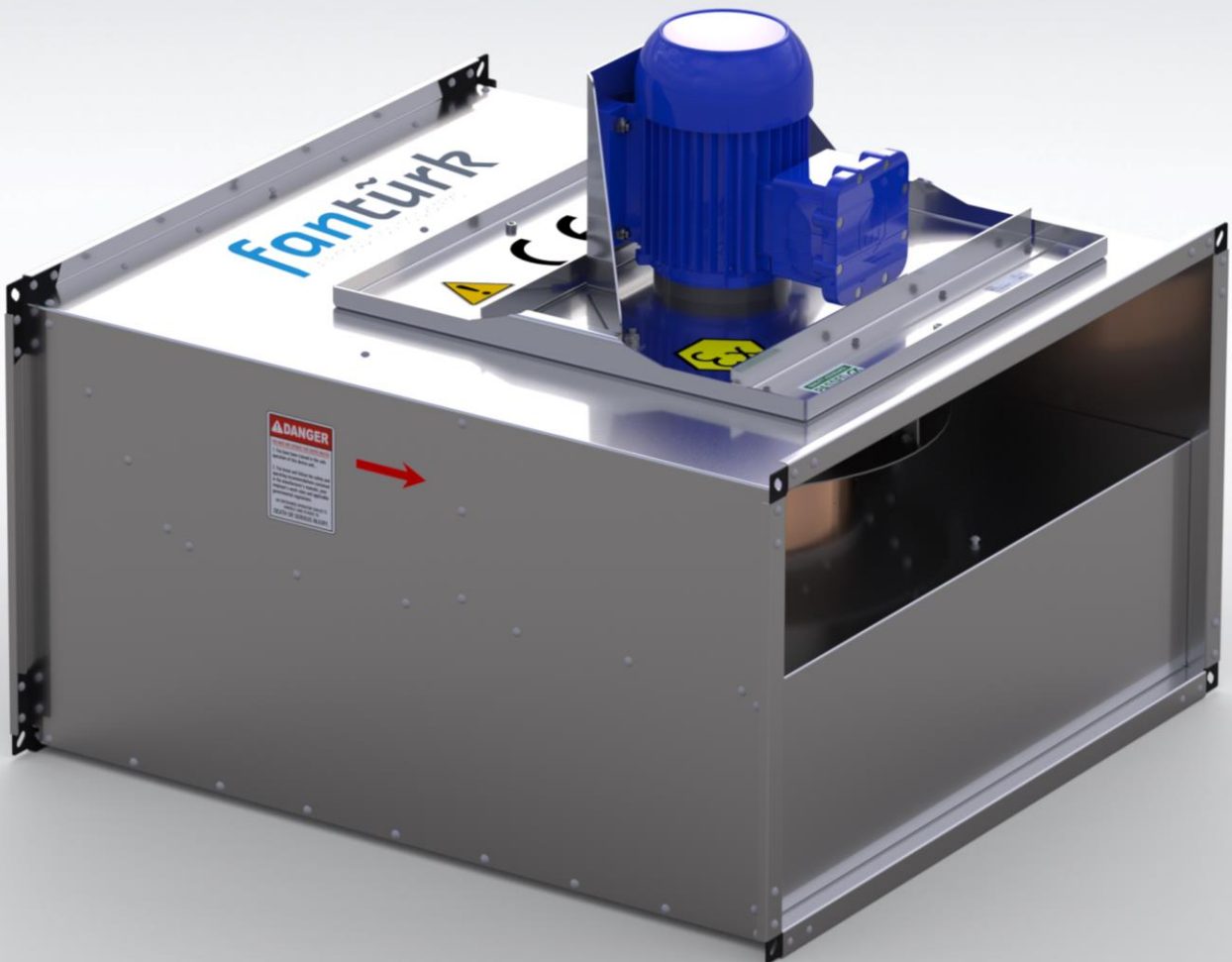

## Technical Specifications

### RECTANGULAR DUCT TYPE IN-LINE FAN

D-KTF series EX-Proof featured rectangular duct type radial fans; they are ideal fans for explosion or flammable environments. It has structure designed not to cause sparks. Area of use are determined according to the Atex directive rating. Thanks to their compact construction, they can be installed directly in the air ducts without the need for large bends and transducers in any position required. D-KTF Ex-Proof series in-line fans are the ideal choice for high performance and trouble-free operation.

Made of high quality corrosion resistant galvanized steel. Optionally, can be manufactured Stainless Steel. Fans are radial fans with backward curved blades. Thanks to the service cover, the fan can carry out maintenance without removing the duct connection. Motors are three phase and has IP65 and Class F insulation. Due to the fact that the motor is out of the air flow, it is protected from the factors that will damage the motor or hot air. This method provides 120 ° C continuous operation. Speed controller is optional for all models.

#### Usage Areas

Can be used for ventilation systems in petrochemical plants, treatment plants, painting facilities, mines and industrial facilities.

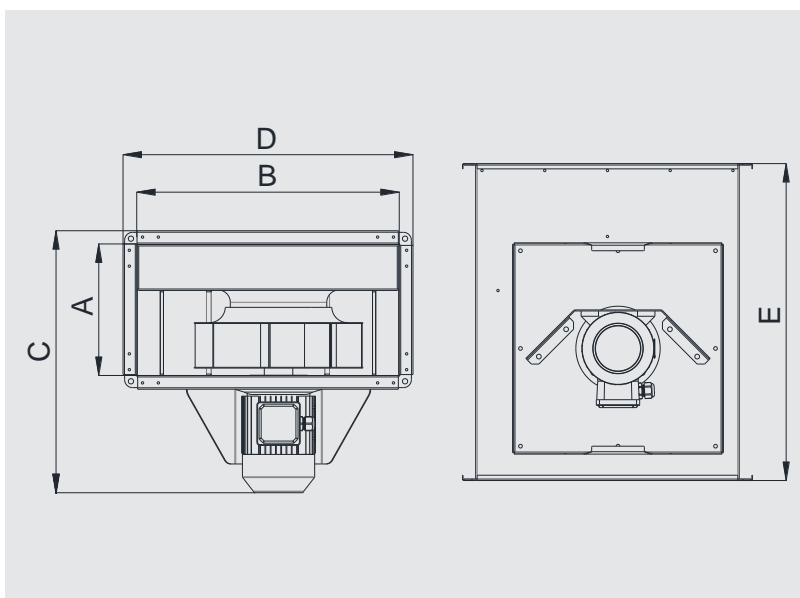
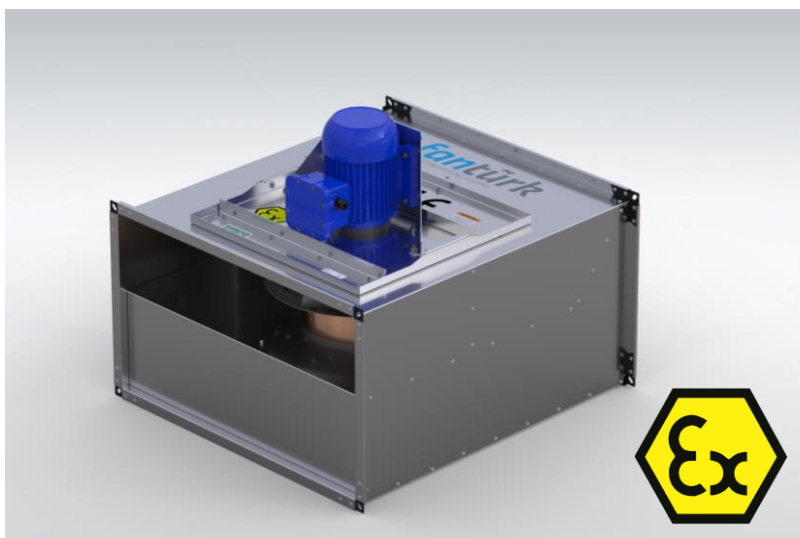

MODEL	A	B	C	D	E	VOLTAGE	FREQUENCY	MOTOR POWER	CURRENT	MOTOR SPEED	AIR FLOW RATE	SOUND PRESSURE LEVEL	WEIGHT
	mm	mm	mm	mm	mm	V	Hz	kW	A	rpm	m <sup>3</sup> /h	dBA	kg
D-KTF 280-EX	250	500	469	550	650	400 460	50 60	0,18 0,22	0,75	1330 1600	1150	48	28
D-KTF 315-EX	250	500	495	550	600	400 460	50 60	0,25 0,30	1,05	1320 1525	2000	53	32
D-KTF 355-EX	300	600	545	650	750	400 460	50 60	0,37 0,44	1,35	1425 1710	2500	55	34
D-KTF 400-EX	400	700	665	750	800	400 460	50 60	0,55 0,66	1,5	1410 1690	3500	56	38
D-KTF 450-EX	400	700	665	750	800	400 460	50 60	0,75 0,90	2,1	1430 1715	5000	58	49
D-KTF 500-EX	500	800	765	850	900	400 460	50 60	1,10 1,32	2,80	1420 1415	7000	61	63
D-KTF 560-EX	500	800	765	850	900	400 460	50 60	1,5 1,80	2,60	1415 1700	9800	64	74

## Performance Curves

### D-KTF 280-EX

Voltage 400/460 V  
Frequency 50/60 Hz  
Motor Power 0,18 kW  
Motor Speed 1330 rpm  
Sound Pressure Level 48 dBA  
Weight 28 kg

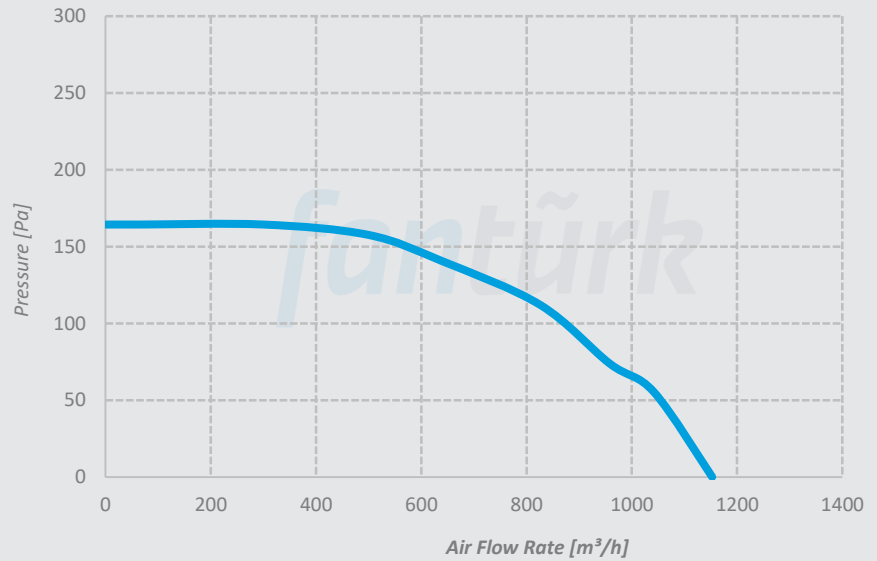

### D-KTF 315-EX

Voltage 400/460 V  
Frequency 50/60 Hz  
Motor Power 0,25 kW  
Motor Speed 1320 rpm  
Sound Pressure Level 53 dBA  
Weight 32 kg

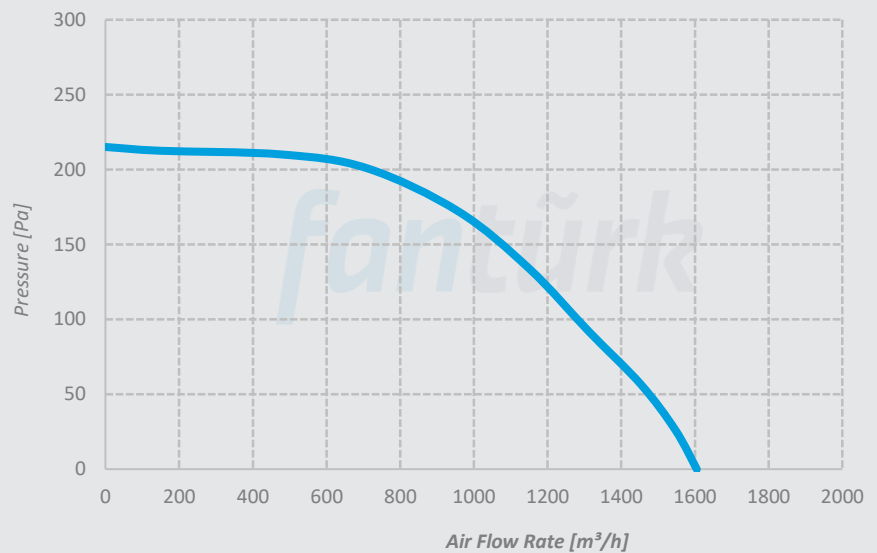

### D-KTF 355

Voltage 400/460 V  
Frequency 50/60 Hz  
Motor Power 0,37 kW  
Motor Speed 1425 rpm  
Sound Pressure Level 55 dBA  
Weight 34 kg

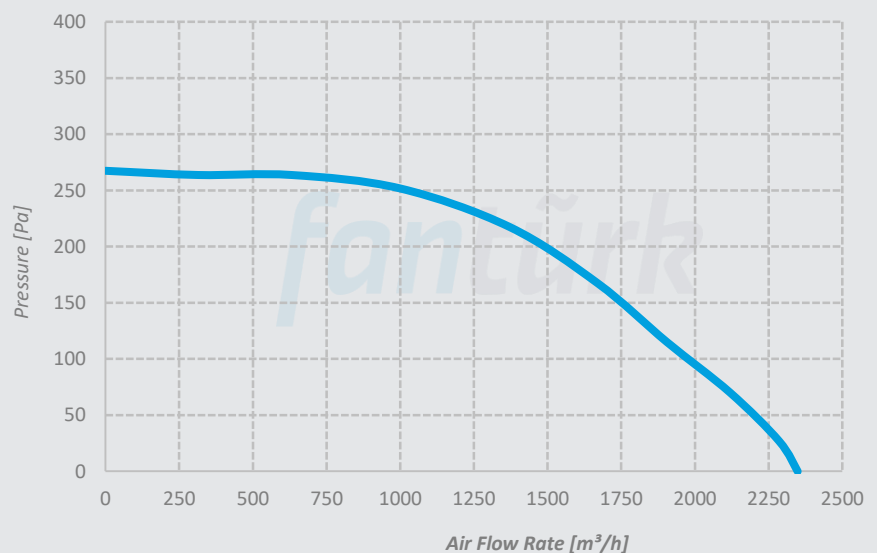

## Performance Curves

### D-KTF 400-EX

Voltage 400/460 V  
Frequency 50/60 Hz  
Motor Power 0,55 kW  
Motor Speed 1410 rpm  
Sound Pressure Level 56 dBA  
Weight 38 kg

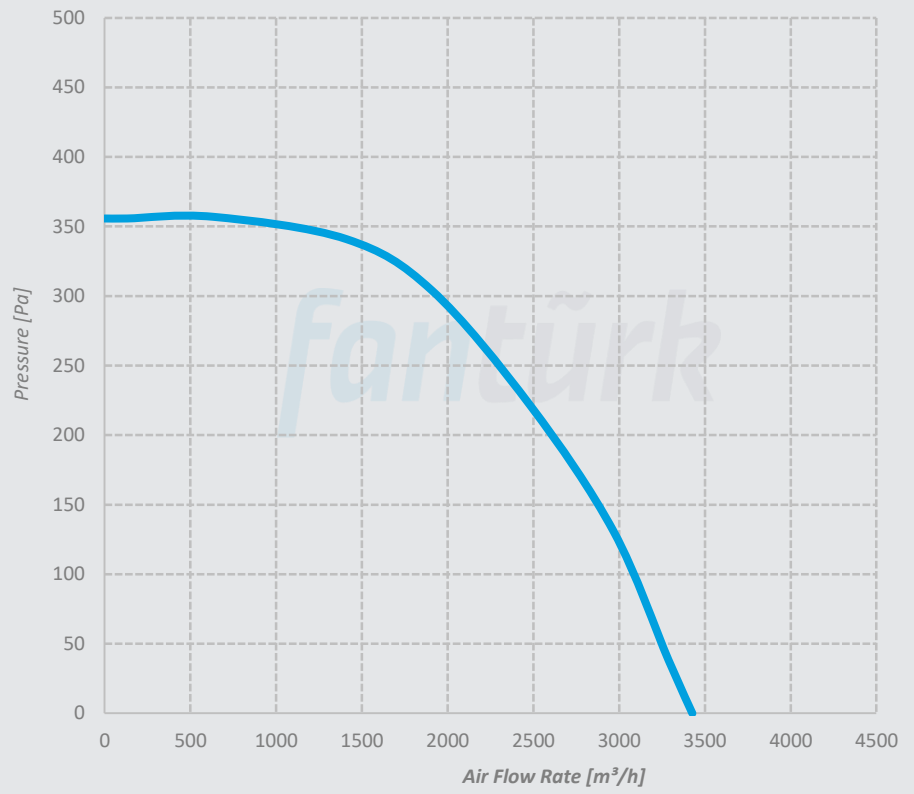

### D-KTF 450-EX

Voltage 400/460 V  
Frequency 50/60 Hz  
Motor Power 0,75 kW  
Motor Speed 1430 rpm  
Sound Pressure Level 58 dBA  
Weight 49 kg

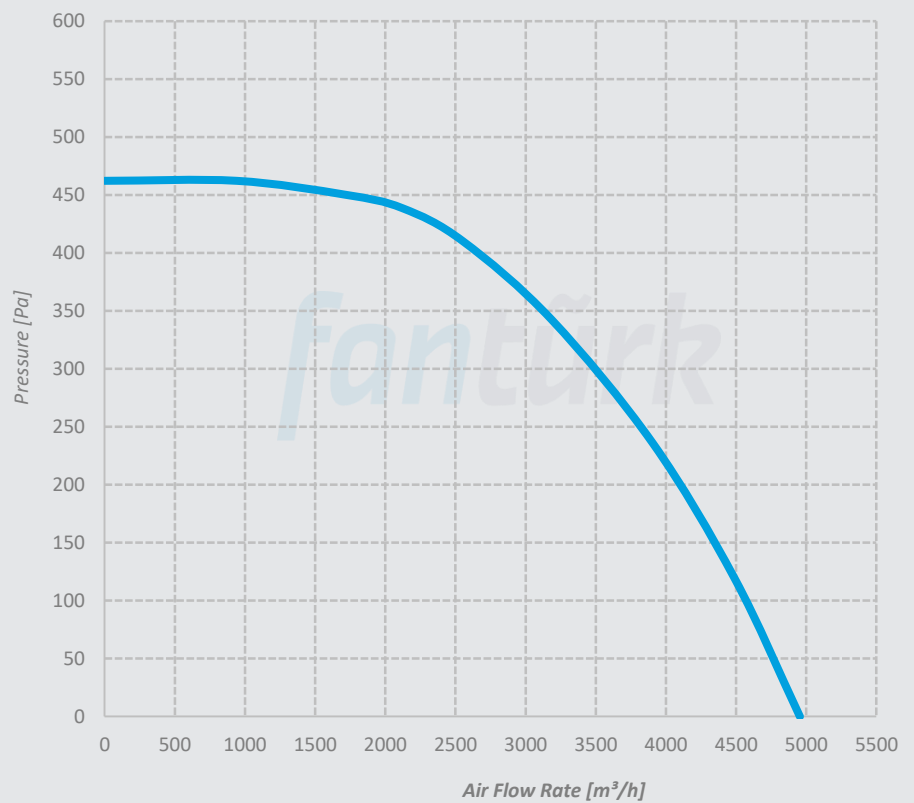



## Performance Curves

### D-KTF 500-EX

Voltage 400/460 V  
Frequency 50/60 Hz  
Motor Power 1,1 kW  
Motor Speed 1420 rpm  
Sound Pressure Level 61 dBA  
Weight 63 kg

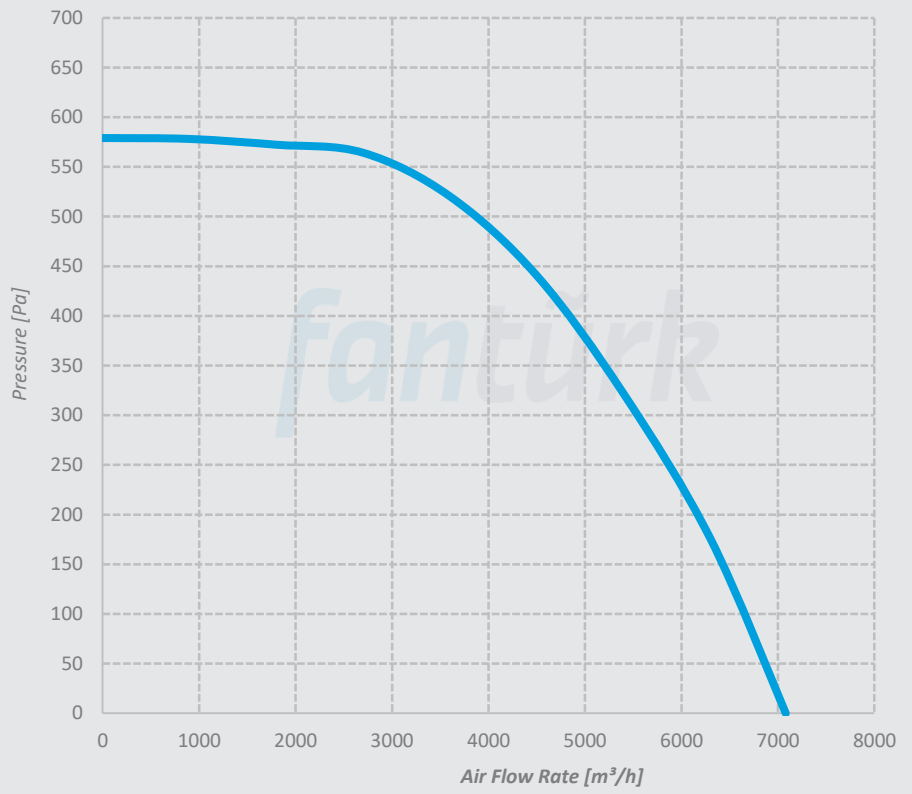

### D-KTF 560-EX

Voltage 400/460 V  
Frequency 50/60 Hz  
Motor Power 1,5 kW  
Motor Speed 1415 rpm  
Sound Pressure Level 64 dBA  
Weight 74 kg

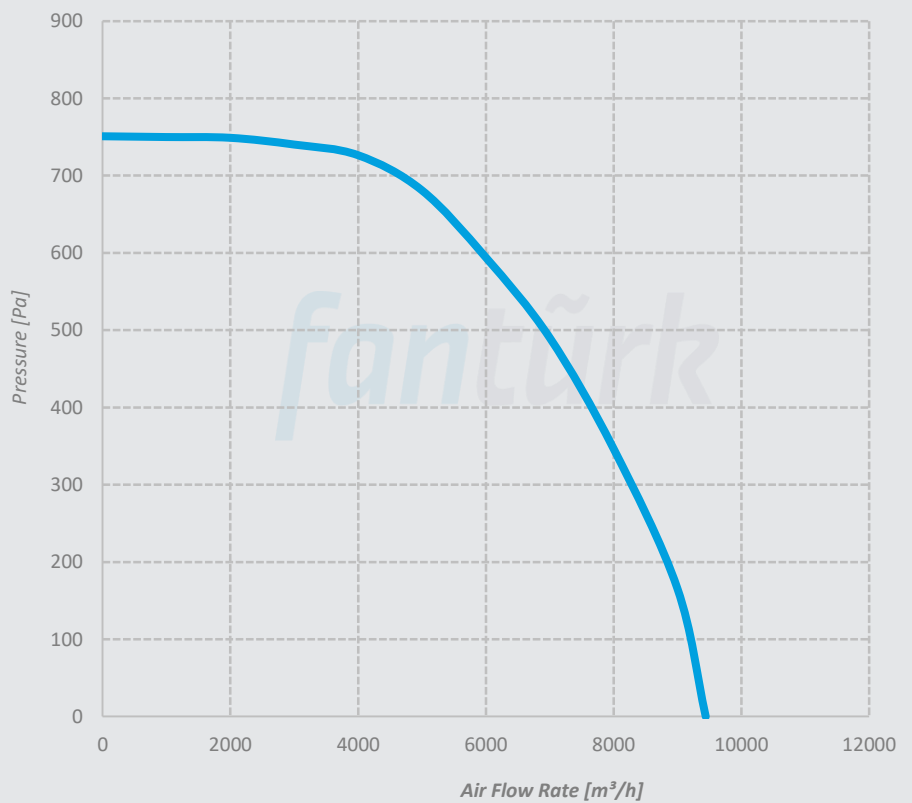



**ÇTF**  
**Roof Type**  
**Radial Fan**

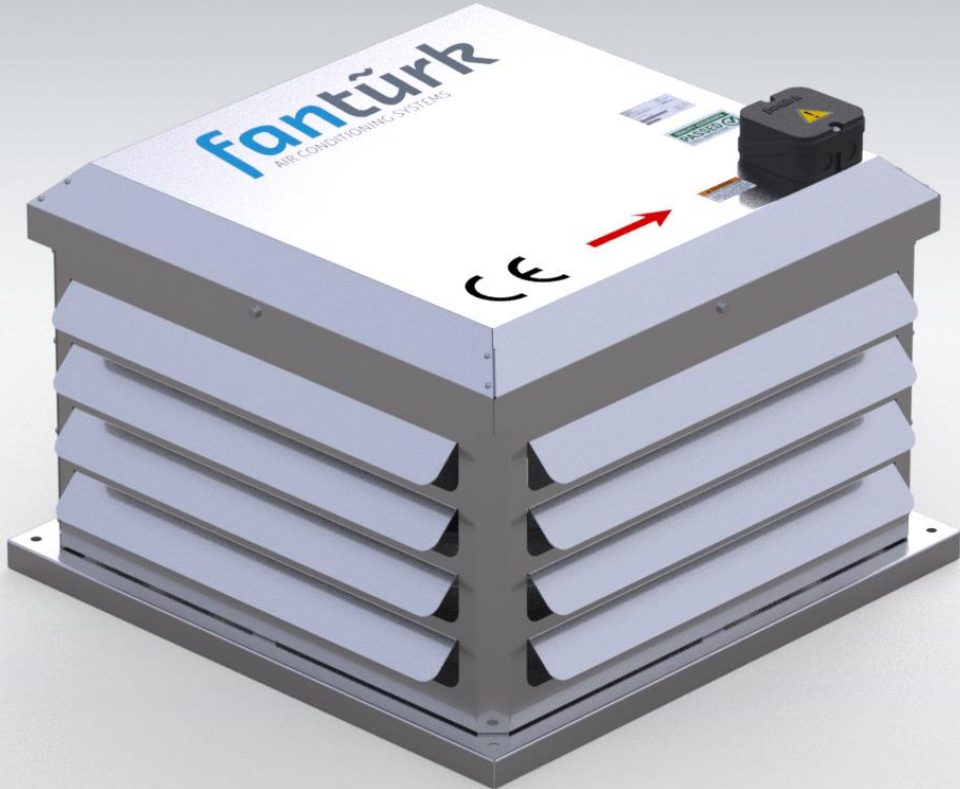

## Technical Specifications

# ROOF TYPE RADIAL FAN

ÇTF (230V) series roof type radial fans; are the ideal fans for roof installation in ventilation systems where high air flow and high pressure are required. They have high performance and trouble-free operation specifications.

Made of high quality corrosion resistant galvanized steel. Fans are radial fans with backward curved blades. Motors are single phase and has IP55 and Class F insulation. Speed controller is optional for all models..

### Usage Areas

Can be used in all kinds of industrial building, office, kitchen and residential building ventilation systems where compact solutions are needed.

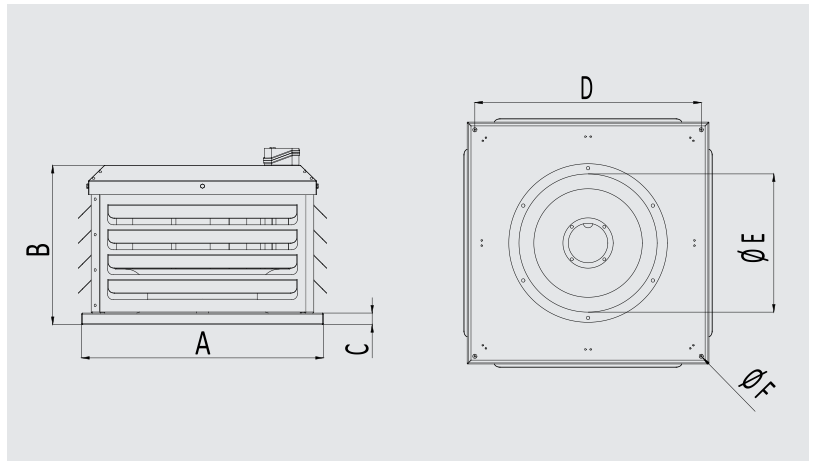
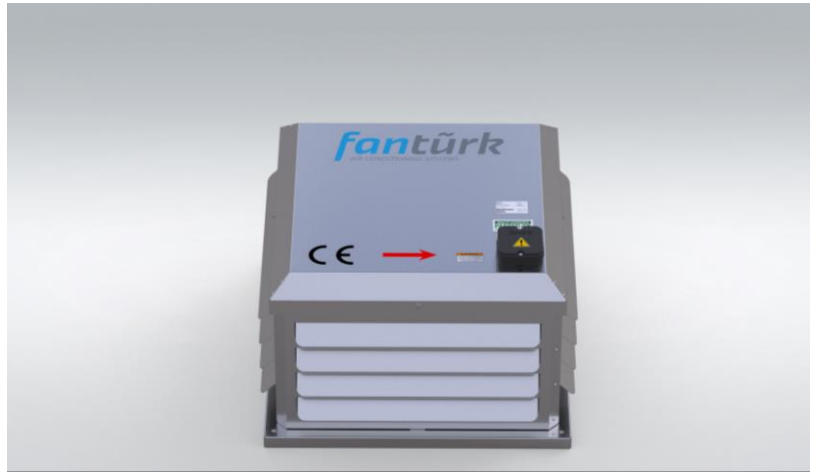

MODEL	A	B	C	D	E	F	VOLTAGE	FREQUENCY	POWER	CURRENT	CAPACITOR	MOTOR SPEED	AIR FLOW RATE	SOUND P. LEVEL	WEIGHT
	mm	mm	mm	mm	mm	mm	V	Hz	W	A	µf	rpm	m <sup>3</sup> /h	dBA	kg
ÇTF-1	320	171	30	280	145	9	230	50	76	0,29	1,5	2350	540	52	6,5
ÇTF-2	350	180	30	310	210	9	230	50	100	0,47	2,5	2580	925	56	8,3
ÇTF-3	360	210	30	320	195	9	230	50	160	0,68	3,5	2600	1150	63	8,5
ÇTF-4	380	220	30	340	220	9	230	50	180	0,8	5	2700	1520	58	9,7
ÇTF-5	410	250	30	370	250	9	230	50	285	1,5	7	2500	2110	76	11
ÇTF-6	500	300	30	460	270	9	230	50	272	1,23	12	1364	3150	72	17
ÇTF-7	570	352	30	530	320	11	230	50	500	1,8	9	1380	4400	61	28
ÇTF-8	630	400	30	590	390	11	230	50	800	3,7	14	1359	6000	62	31

## Performance Curves

### ÇTF-1

Voltage 230 V  
Frequency 50 Hz  
Current 76 W  
Current 0,29 A  
Capacitor 2,5  $\mu$ f  
Motor Speed 2350 rpm  
Flow Rate 540 m<sup>3</sup>/h  
Sound Pressure Level 52 dBA  
Weight 6,5 kg

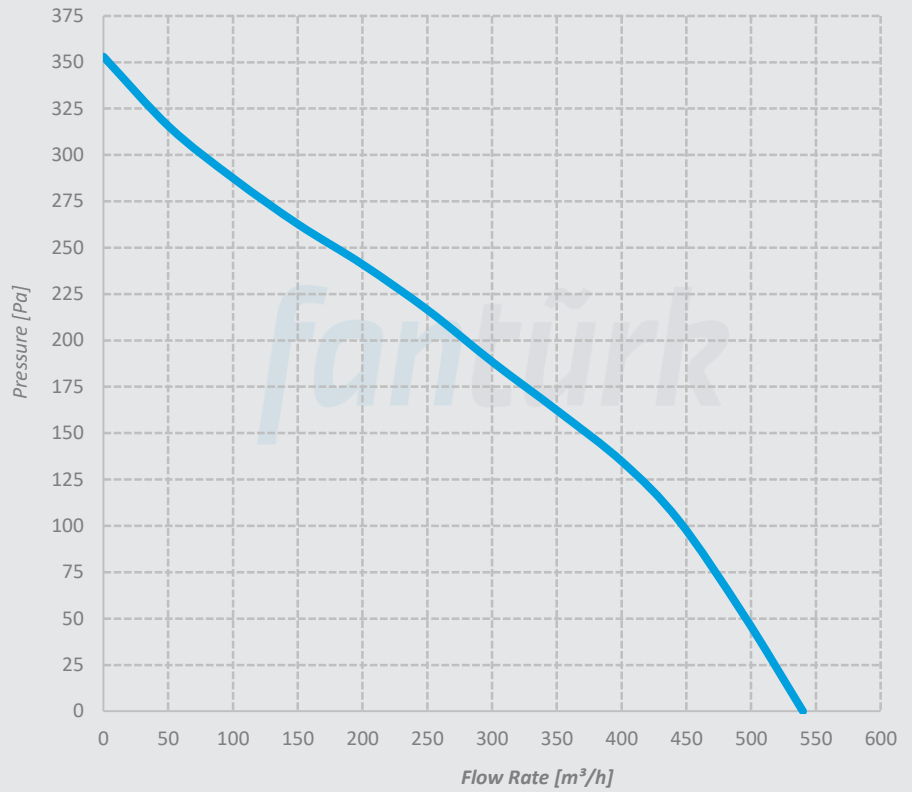

### ÇTF-2

Voltage 230 V  
Frequency 50 Hz  
Current 100 W  
Current 0,47 A  
Capacitor 3  $\mu$ f  
Motor Speed 2580 rpm  
Flow Rate 925 m<sup>3</sup>/h  
Sound Pressure Level 56 dBA  
Weight 8,3 kg

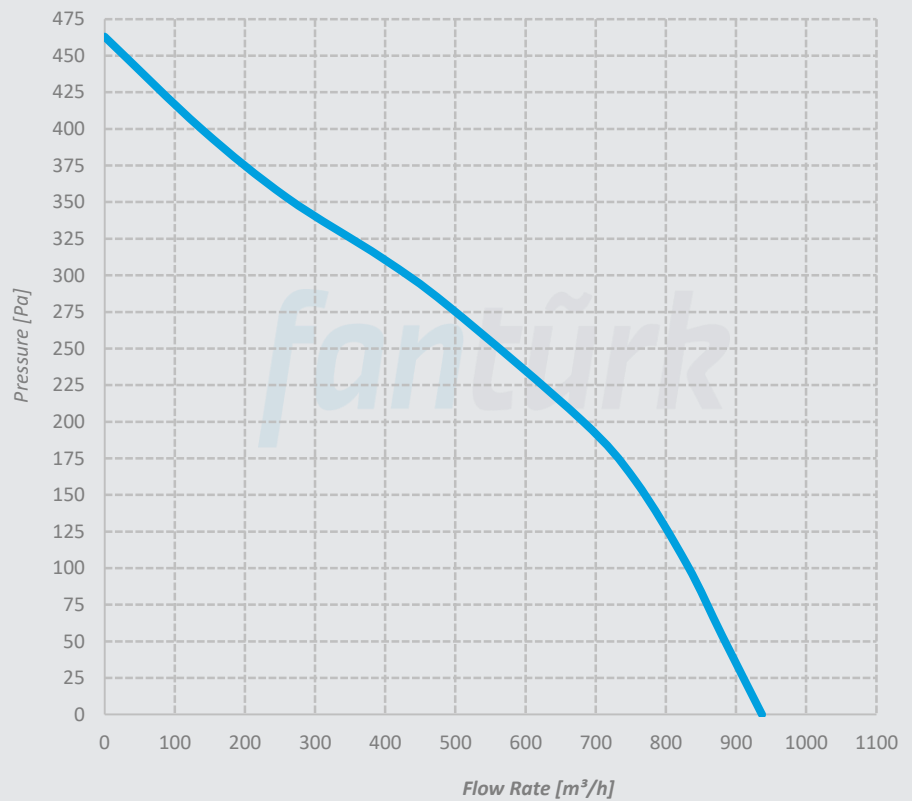

## Performance Curves

### ÇTF-3

**Voltage** 230 V  
**Frequency** 50 Hz  
**Current** 160 W  
**Current** 0,68 A  
**Capacitor** 4  $\mu$ f  
**Motor Speed** 2600 rpm  
**Flow Rate** 1150 m<sup>3</sup>/h  
**Sound Pressure Level** 63 dBA  
**Weight** 8,5 kg

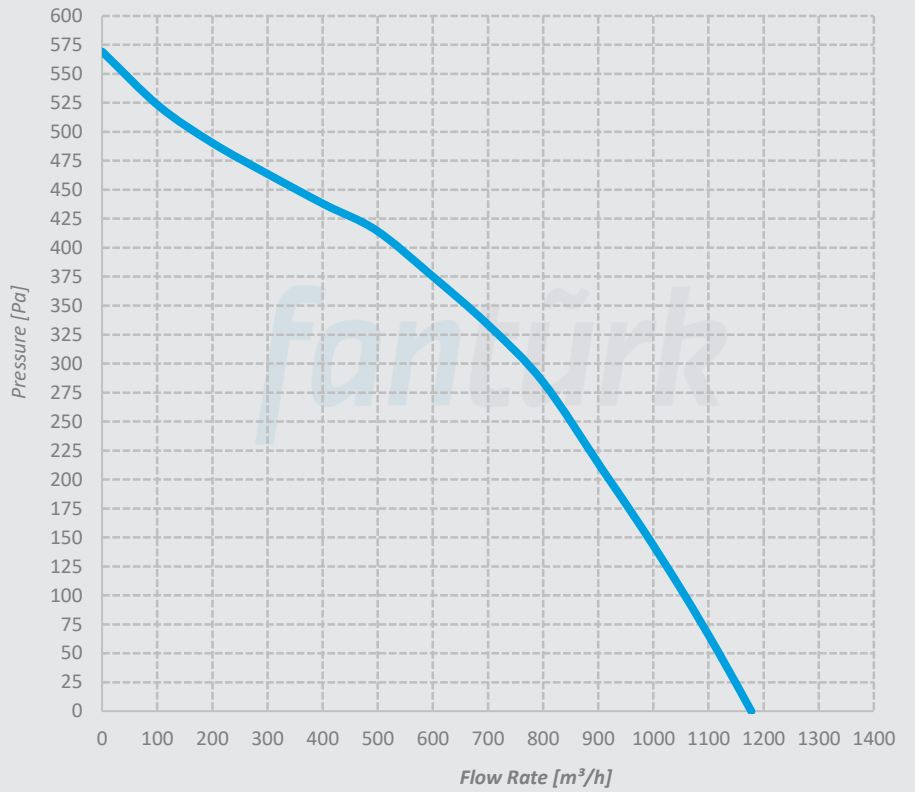

### ÇTF-4

**Voltage** 230 V  
**Frequency** 50 Hz  
**Current** 180 W  
**Current** 0,8 A  
**Capacitor** 4  $\mu$ f  
**Motor Speed** 2700 rpm  
**Flow Rate** 1520 m<sup>3</sup>/h  
**Sound Pressure Level** 58 dBA  
**Weight** 9,7 kg

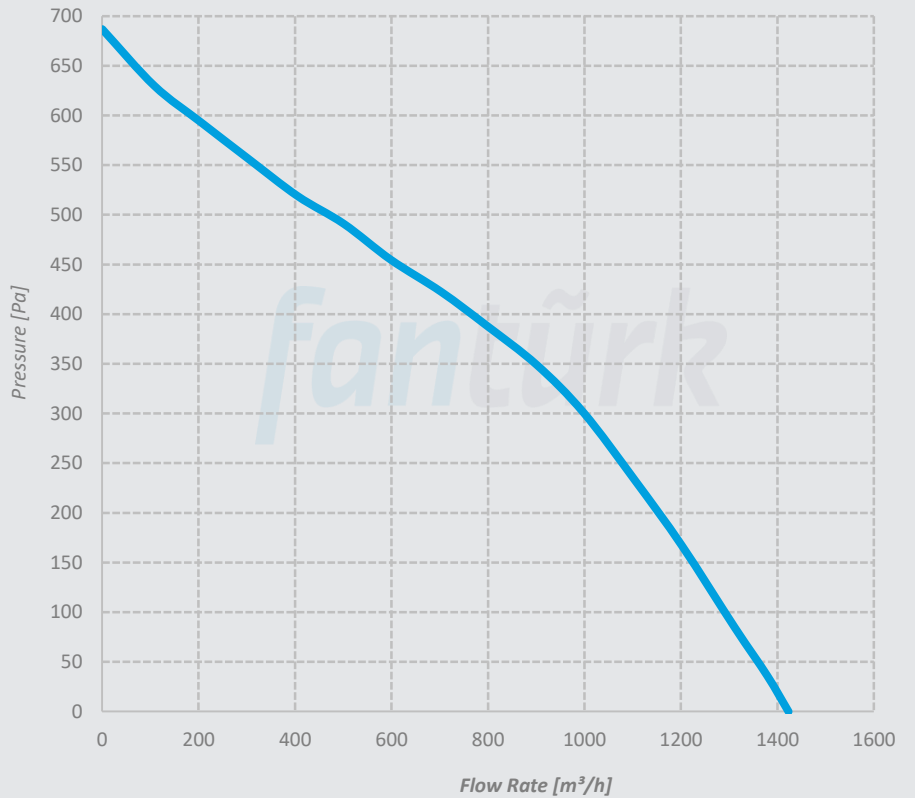

## Performance Curves

### ÇTF-5

Voltage 230 V  
Frequency 50 Hz  
Current 285 W  
Current 1,5 A  
Capacitor 5  $\mu$ f  
Motor Speed 2500 rpm  
Flow Rate 2110 m<sup>3</sup>/h  
Sound Pressure Level 76 dBA  
Weight 11 kg

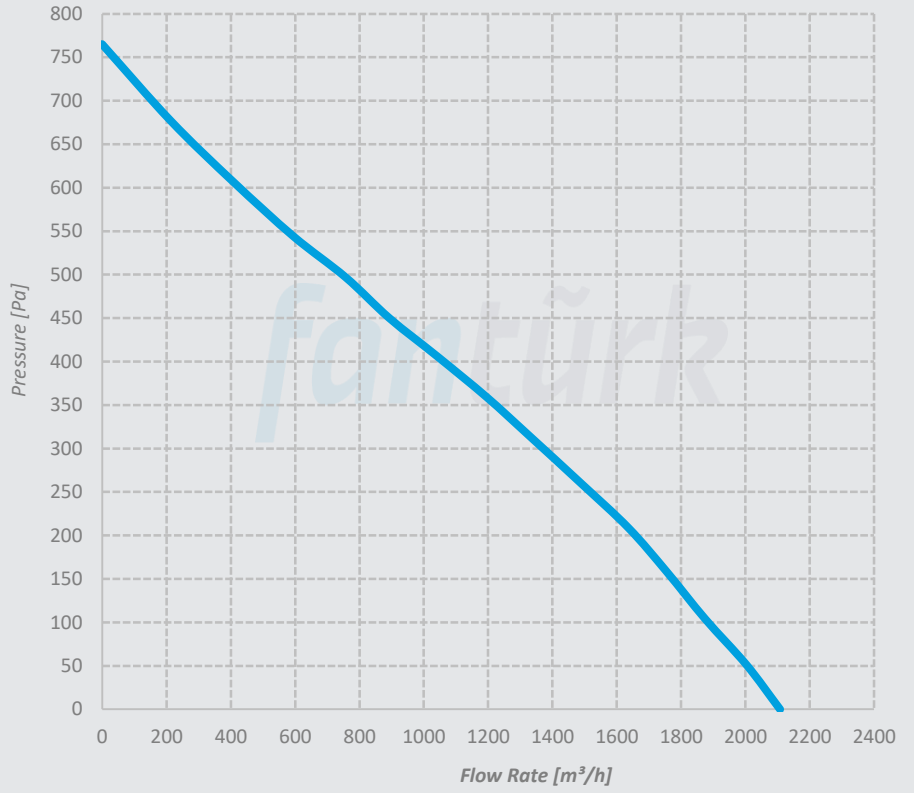

### ÇTF-6

Voltage 230 V  
Frequency 50 Hz  
Current 272 W  
Current 1,23 A  
Capacitor 8  $\mu$ f  
Motor Speed 1364 rpm  
Flow Rate 3150 m<sup>3</sup>/h  
Sound Pressure Level 72 dBA  
Weight 17 kg

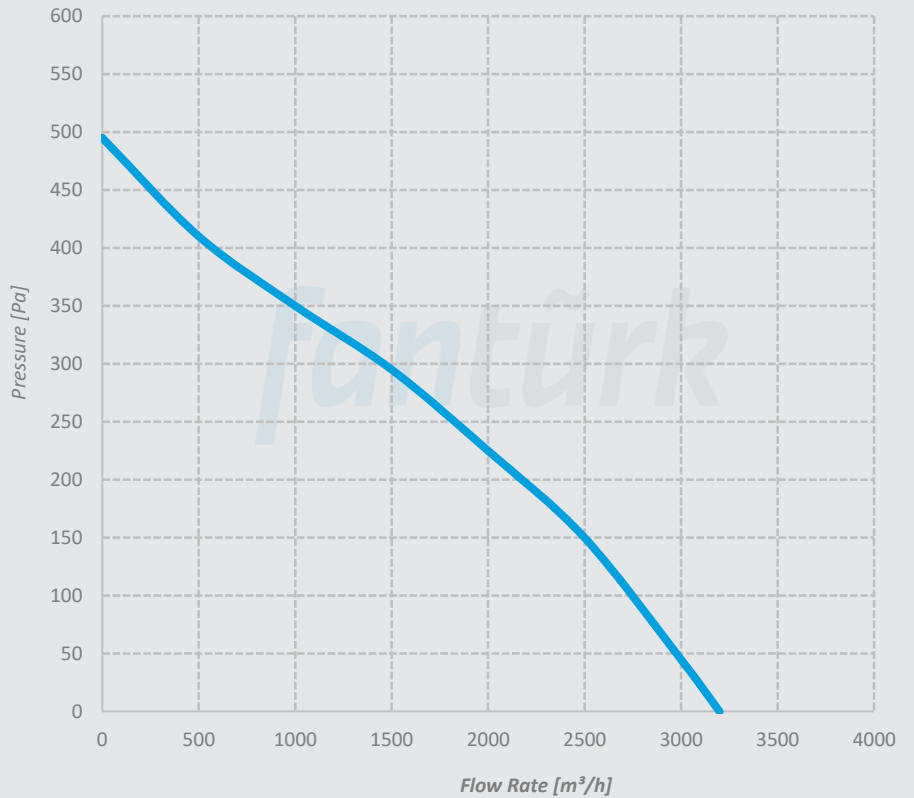

## Performance Curves

### ÇTF-7

Voltage 230 V  
Frequency 50 Hz  
Current 500 W  
Current 1,8 A  
Capacitor 12  $\mu$ f  
Motor Speed 1380 rpm  
Flow Rate 4400 m<sup>3</sup>/h  
Sound Pressure Level 61 dBA  
Weight 28 kg

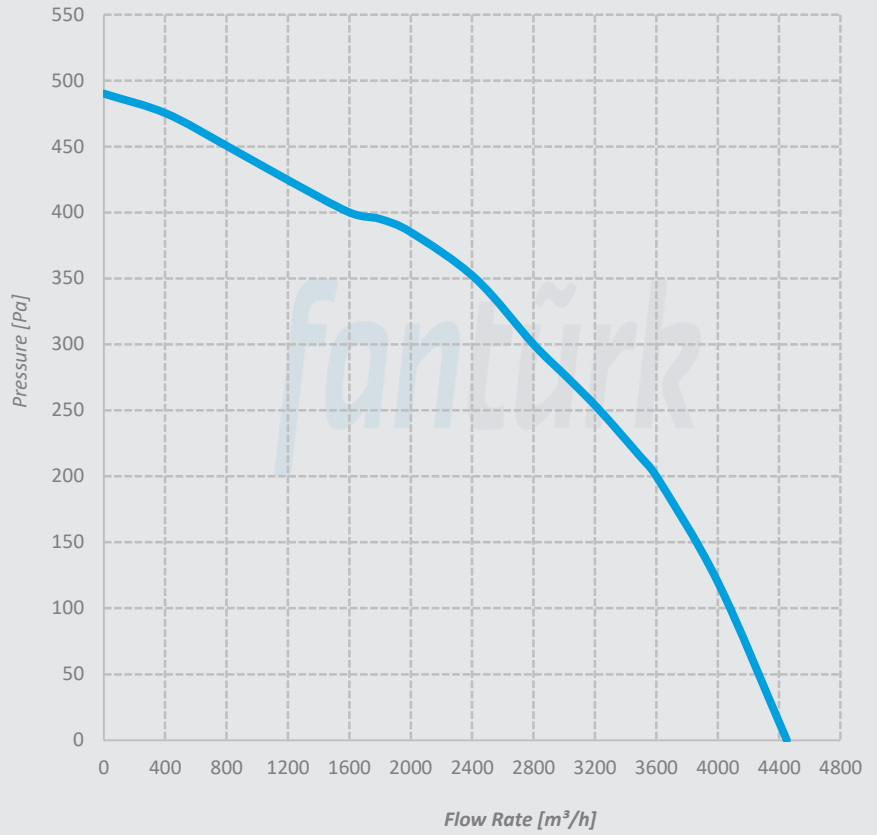

### ÇTF-8

Voltage 230 V  
Frequency 50 Hz  
Current 800 W  
Current 3,7 A  
Capacitor 16  $\mu$ f  
Motor Speed 1359 rpm  
Flow Rate 6000 m<sup>3</sup>/h  
Sound Pressure Level 62 dBA  
Weight 31 kg

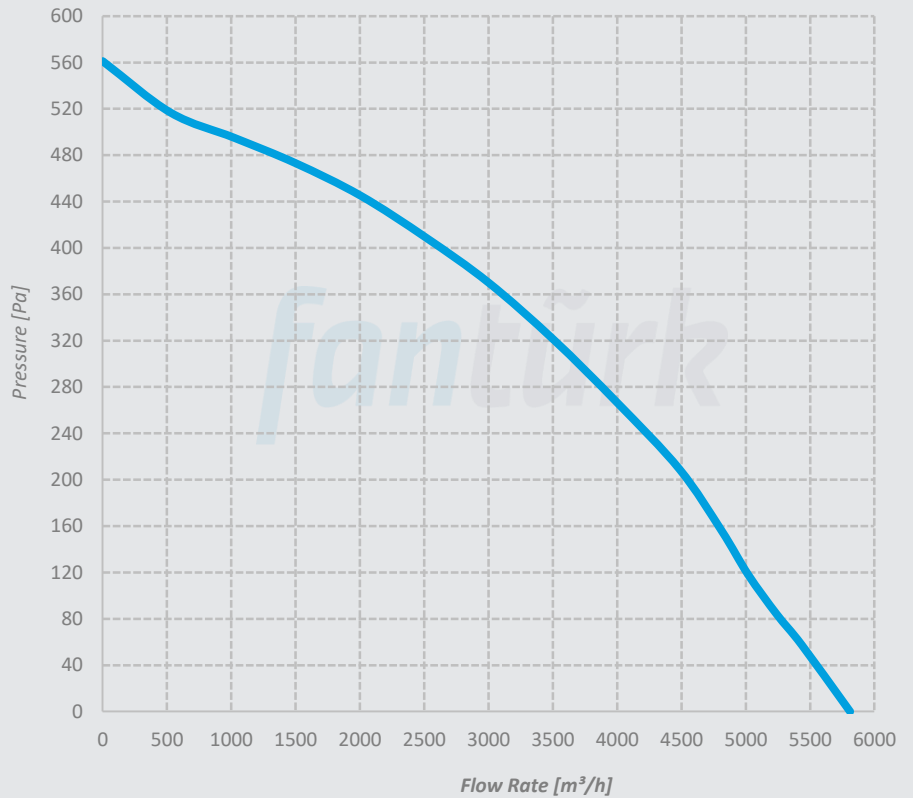



**ÇTF**  
**External Driven Roof**  
**Type Horizontal Flow**  
**Radial Fan**

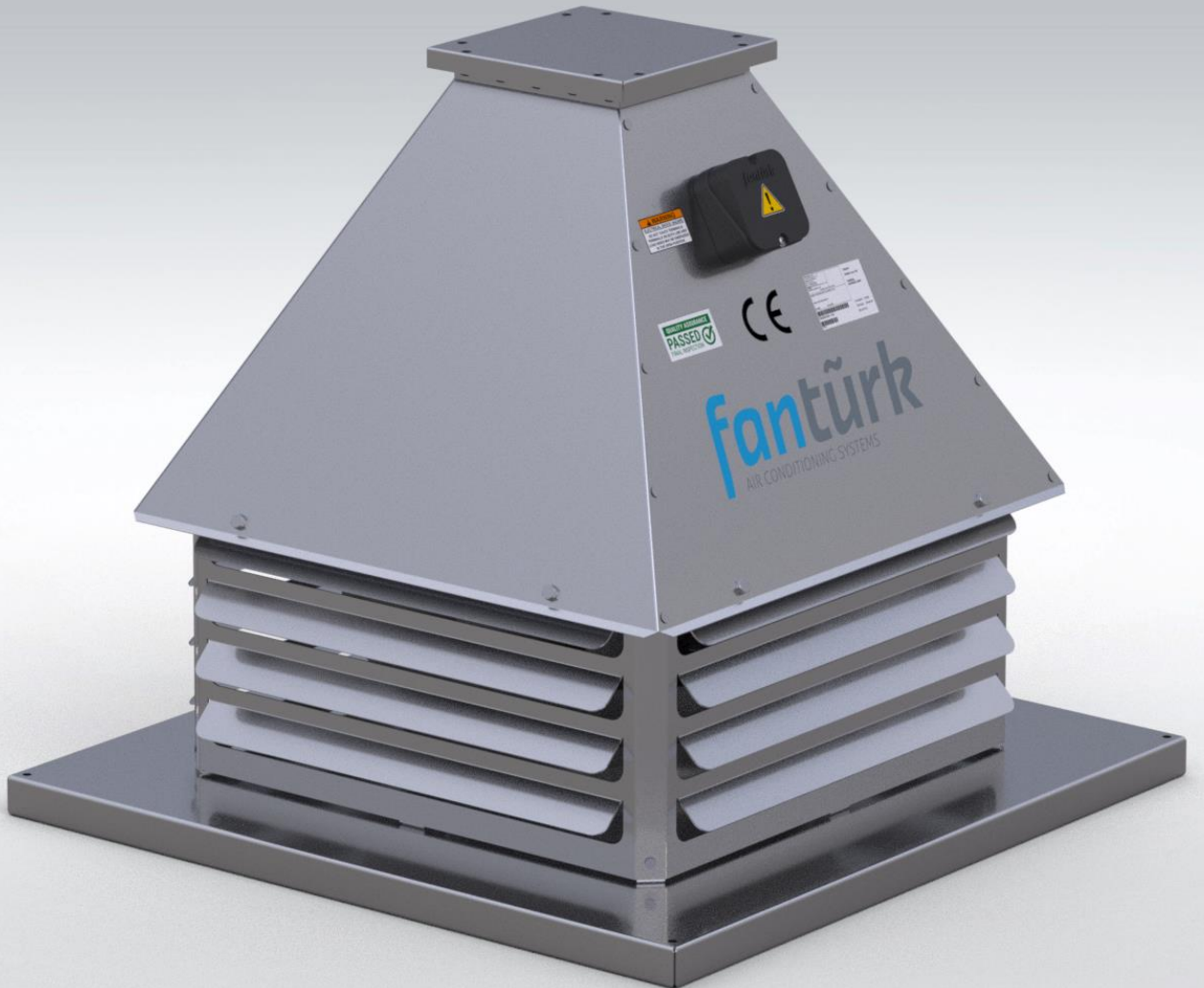



## Technical Specifications

# EXTERNAL DRIVEN ROOF TYPE HORIZONTAL FLOW RADIAL FAN

ÇTF (380V) series roof type radial fans; are the ideal fans for roof installation in ventilation systems where high air flow and high pressure are required.

Made of high quality corrosion resistant galvanized steel. Fans are radial fans with backward curved blades. Motors are three-phase and have 4 pole, IP55 and Class F insulation. Due to the fact that the motor is out of the air flow, it is protected from the factors that will damage the motor or hot air. This method provides 120 ° C continuous operation. Frequency controller is optional for all models.

### Usage Areas

Can be used in ventilation systems where the exhaust air is likely to damage the motor, in oily exhaust air from kitchens, and all kinds of industrial buildings, office and residential buildings.

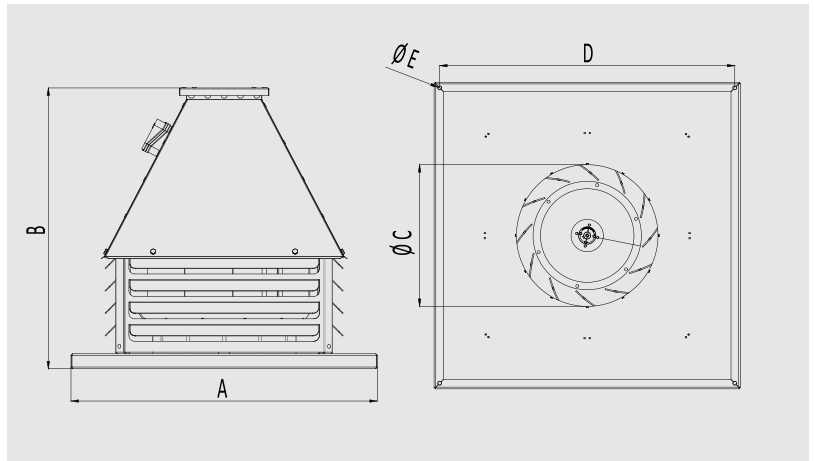

MODEL	A	B	C	D	E	VOLTAGE	FREQUENCY	POWER	CURRENT	MOTOR SPEED	AIR FLOW RATE	PRESSURE	SOUND PRESSURE LEVEL	WEIGHT
	mm	mm	mm	mm	mm	V	Hz	kW	A	rpm	m <sup>3</sup> /h	Pa	dBA	kg
ÇTF 250/0.37	620	583	257	590	9	380	50	0,37	1,2	1360	2800	250	62	55
ÇTF 280/0.55	670	603	260	640	9	380	50	0,55	1,6	1370	4450	250	64	60
ÇTF 315/1.1	720	638	291	690	9	380	50	1,1	2,6	1390	7000	250	67	70
ÇTF 355/2.2	820	751	379	790	9	380	50	2,2	5,2	1420	8200	250	69	80
ÇTF 400/1.1	870	761	395	840	9	380	50	1,1	2,9	930	9000	250	60	85
ÇTF 400/4	870	761	395	840	9	380	50	4	8,2	1430	14000	400	70	105
ÇTF 450/2.2	950	955	430	920	9	380	50	2,2	5,4	950	13300	250	63	130
ÇTF 450/5.5	950	955	430	920	9	380	50	5,5	11,2	1440	18200	400	71	138
ÇTF 450/7.5	950	955	430	920	9	380	50	7,5	15,4	1450	20900	500	72	151

## Performance Curves

### ÇTF 250/0,37

Voltage 380 V  
Frequency 50 Hz  
Motor Power 0,37 kW  
Motor Speed 1360 rpm  
Sound Pressure Level 62 dBA  
Weight 55 kg

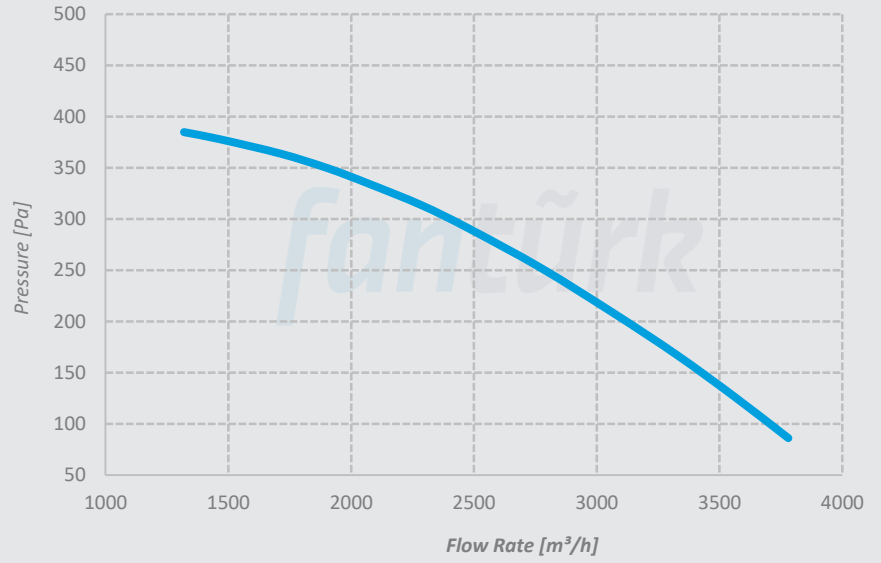

### ÇTF 280/0,55

Voltage 380 V  
Frequency 50 Hz  
Motor Power 0,55 kW  
Motor Speed 1370 rpm  
Sound Pressure Level 64 dBA  
Weight 60 kg

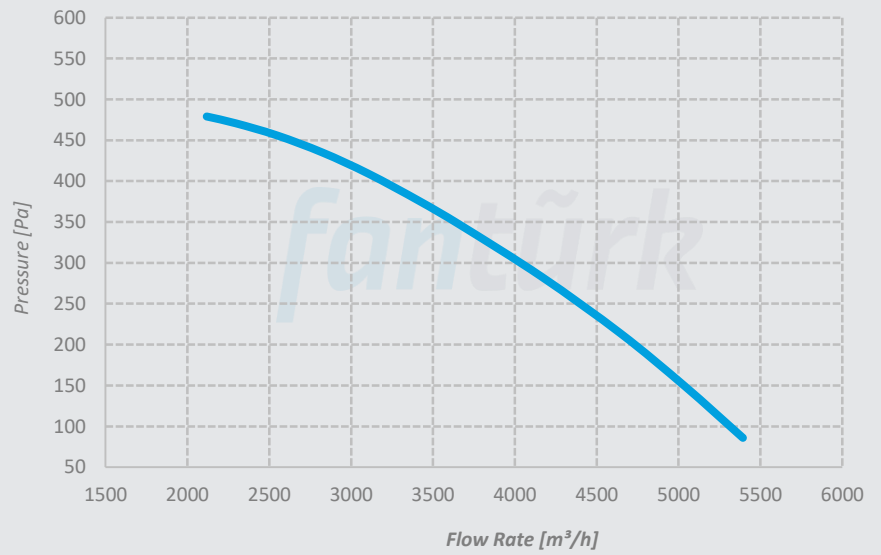

### ÇTF 315/1,1

Voltage 380 V  
Frequency 50 Hz  
Motor Power 1,1 kW  
Motor Speed 1390 rpm  
Sound Pressure Level 67 dBA  
Weight 70 kg

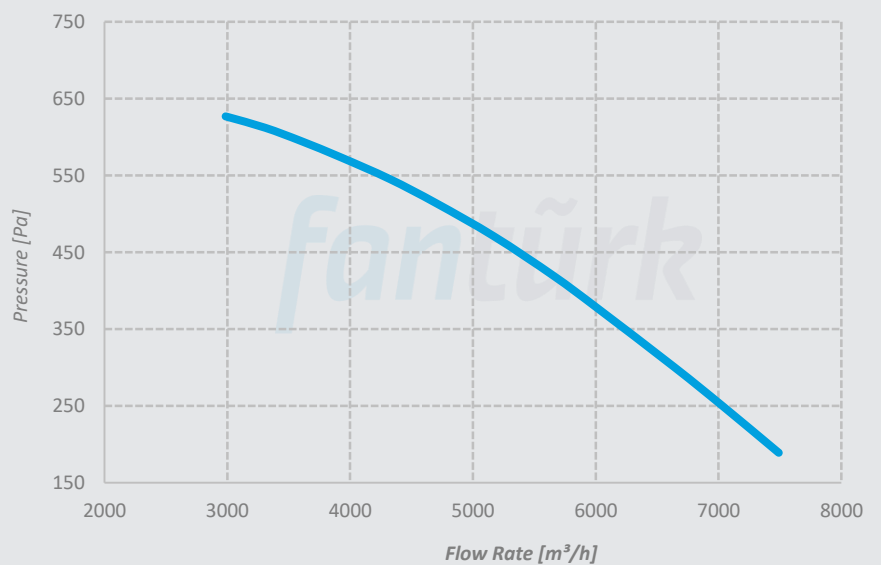

## Performance Curves

### ÇTF 355/2,2

Voltage 380 V  
Frequency 50 Hz  
Motor Power 2,2 kW  
Motor Speed 1420 rpm  
Sound Pressure Level 69 dBA  
Weight 80 kg

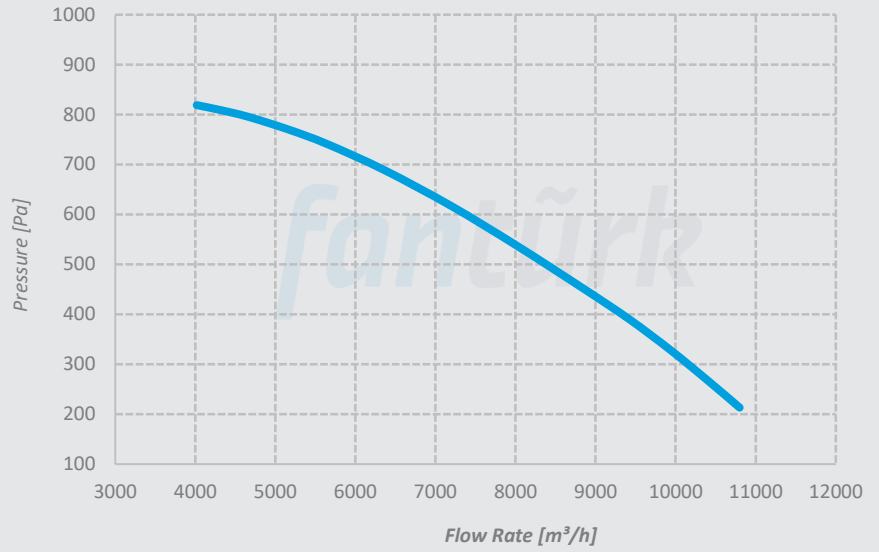

### ÇTF 400/1,1

Voltage 380 V  
Frequency 50 Hz  
Motor Power 1,1 kW  
Motor Speed 930 rpm  
Sound Pressure Level 60 dBA  
Weight 85 kg

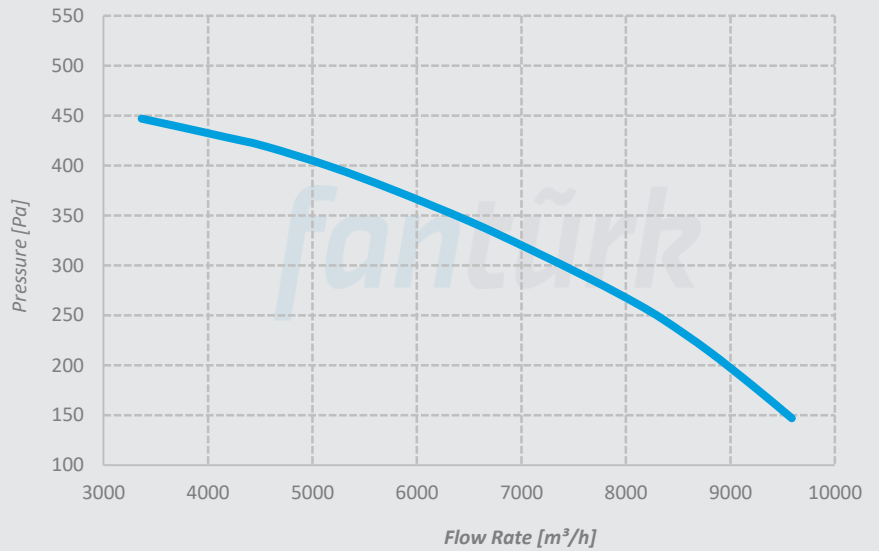

### ÇTF 400/4

Voltage 380 V  
Frequency 50 Hz  
Motor Power 4 kW  
Motor Speed 1430 rpm  
Sound Pressure Level 70 dBA  
Weight 105 kg

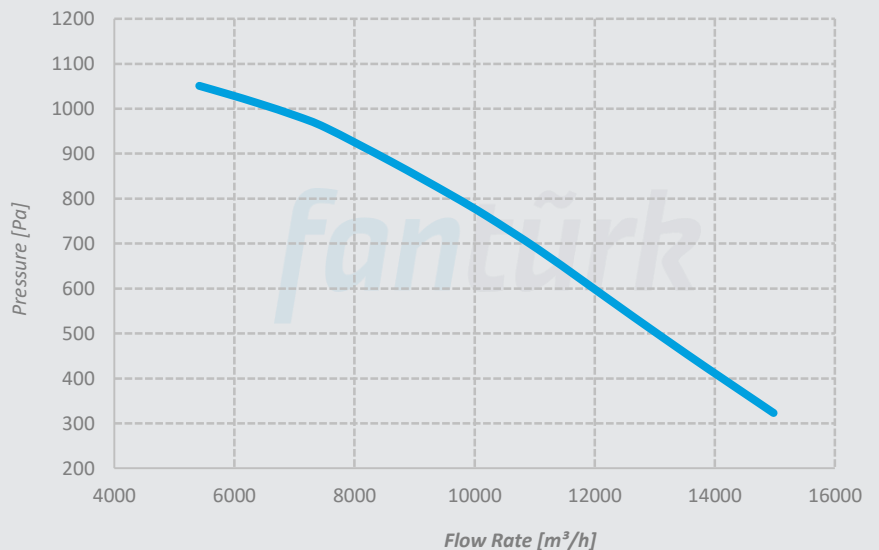

## Performance Curves

### ÇTF 450/2,2

Voltage 380 V  
Frequency 50 Hz  
Motor Power 2,2 kW  
Motor Speed 950 rpm  
Sound Pressure Level 63 dBA  
Weight 130 kg

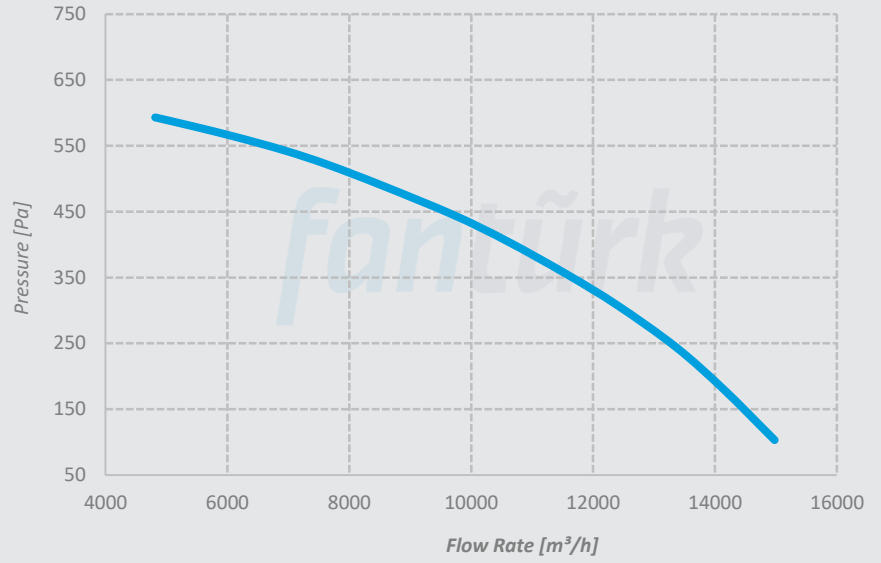

### ÇTF 450/5,5

Voltage 380 V  
Frequency 50 Hz  
Motor Power 5,5 kW  
Motor Speed 1440 rpm  
Sound Pressure Level 71 dBA  
Weight 130 kg

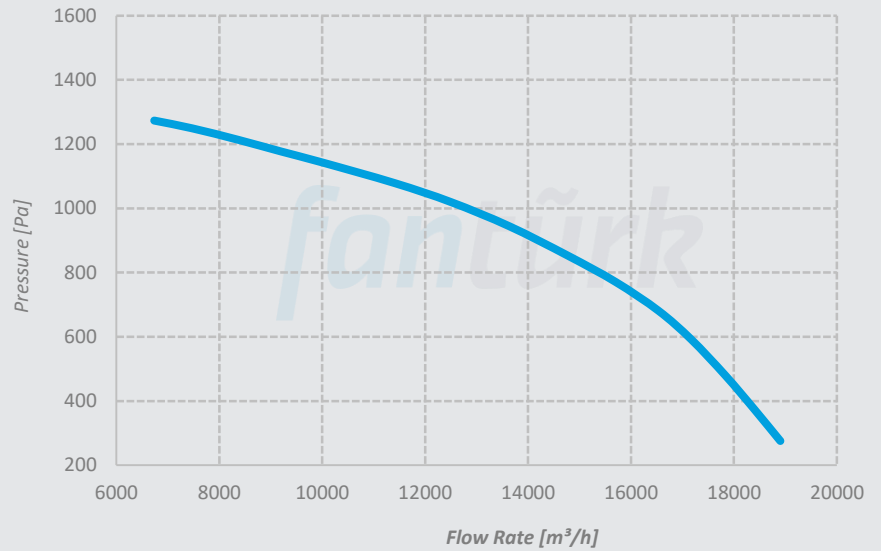

### ÇTF 450/7,5

Voltage 380 V  
Frequency 50 Hz  
Motor Power 7,5 kW  
Motor Speed 1450 rpm  
Sound Pressure Level 72 dBA  
Weight 151 kg

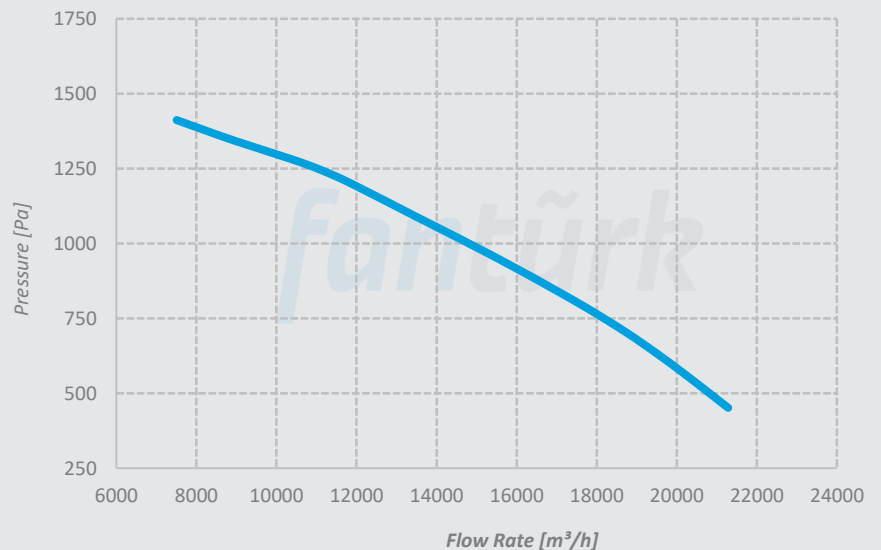



**ÇTF**  
**External Driven Roof**  
**Type Vertical Flow**  
**Radial Fan**

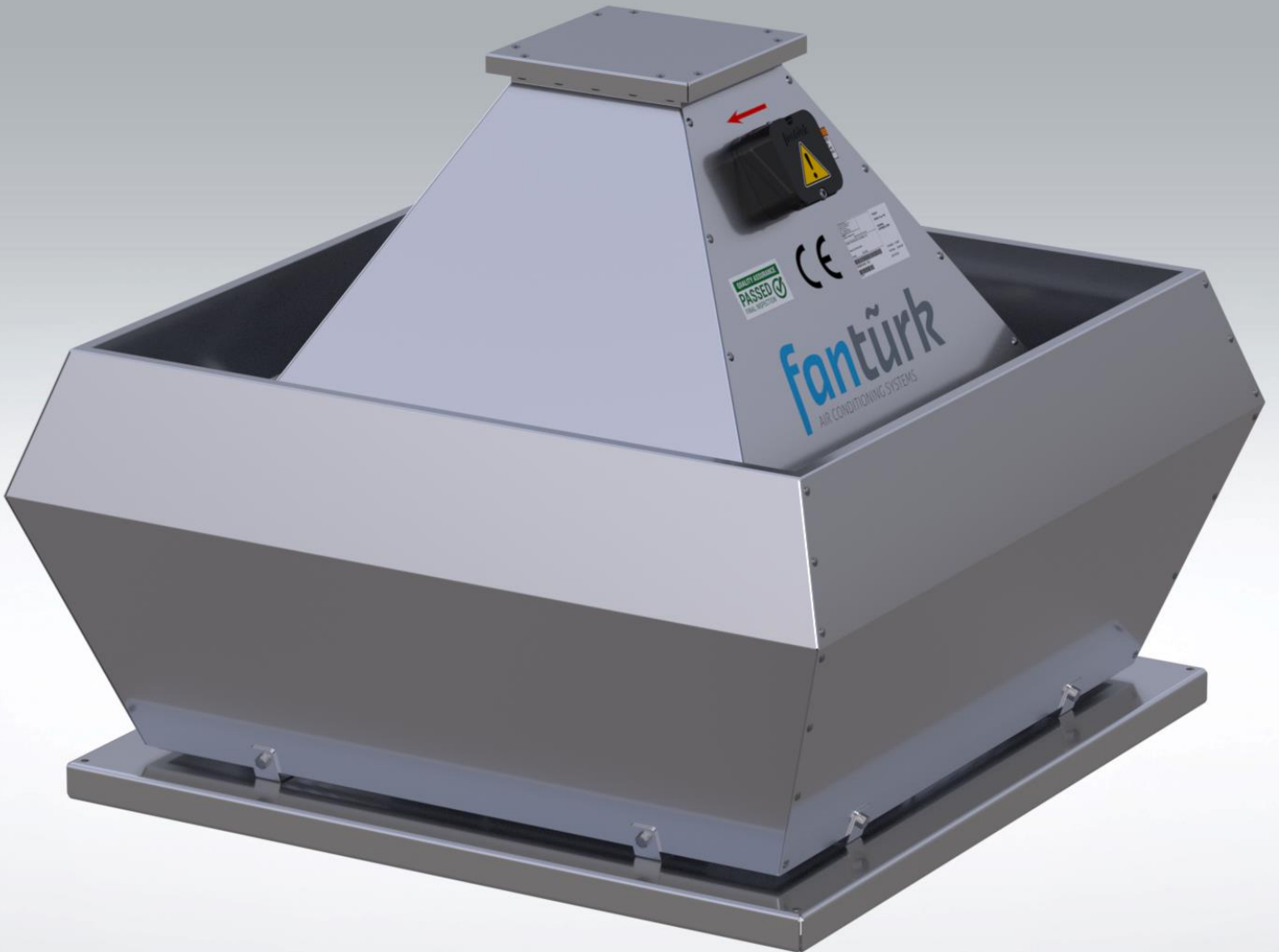

## Technical Specifications

# EXTERNAL DRIVEN ROOF TYPE VERTICAL FLOW RADIAL FAN

ÇTF (380V) series roof type radial fans; are the ideal fans for roof installation in ventilation systems where high air flow and high pressure are required. Airflow is provided in the vertical direction thanks to a part mounted on the body.

Made of high quality corrosion resistant galvanized steel. Fans are radial fans with backward curved blades. Motors are three-phase and have 4 pole, IP55 and Class F insulation. Due to the fact that the motor is out of the air flow, it is protected from the factors that will damage the motor or hot air. This method provides 120 °C continuous operation. Frequency controller is optional for all models.

### Usage Areas

Can be used in ventilation systems where the exhaust air is likely to damage the motor, in oily exhaust air from kitchens, and all kinds of industrial buildings, office and residential buildings.

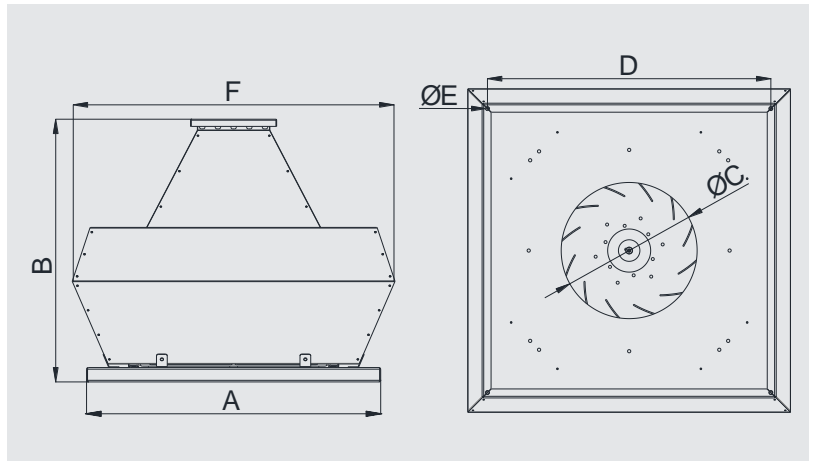
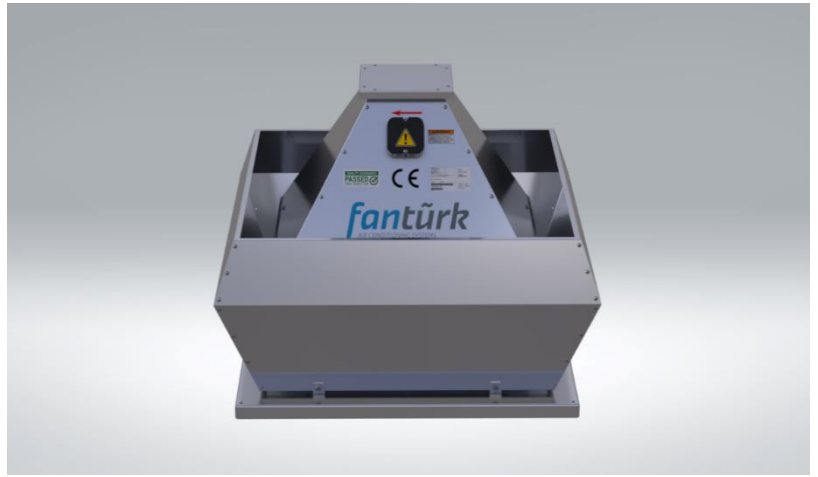

MODEL	A	B	C	D	E	F	VOLTAGE	FREQUENCY	MOTOR POWER	CURRENT	MOTOR SPEED	FLOW RATE	PRESSURE	SOUND P. LEVEL	WEIGHT
	mm	mm	mm	mm	mm	mm	V	Hz	kW	A	rpm	m <sup>3</sup> /h	Pa	dBa	kg
ÇTF 250/0.37	620	583	257	590	9	800	380	50	0,37	1,2	1360	2800	250	62	65
ÇTF 280/0.55	670	603	260	640	9	800	380	50	0,55	1,6	1370	4450	250	64	70
ÇTF 315/1.1	720	638	291	690	9	850	380	50	1,1	2,6	1390	7000	250	67	81
ÇTF 355/2.2	820	751	379	790	9	900	380	50	2,2	5,2	1420	8200	250	69	92
ÇTF 400/1.1	870	761	395	840	9	950	380	50	1,1	2,9	930	9000	250	60	99
ÇTF 400/4	870	761	395	840	9	950	380	50	4	8,2	1430	14000	400	70	119
ÇTF 450/2.2	950	955	430	920	9	1150	380	50	2,2	5,4	950	13300	250	63	151
ÇTF 450/5.5	950	955	430	920	9	1150	380	50	5,5	11,2	1440	18200	400	71	159
ÇTF 450/7.5	950	955	430	920	9	1150	380	50	7,5	15,4	1450	20900	500	72	172

## Performance Curves

### ÇTF 250/0,37

Voltage 380 V  
Frequency 50 Hz  
Motor Power 0,37 kW  
Motor Speed 1360 rpm  
Sound Pressure Level 62 dBA  
Weight 55 kg

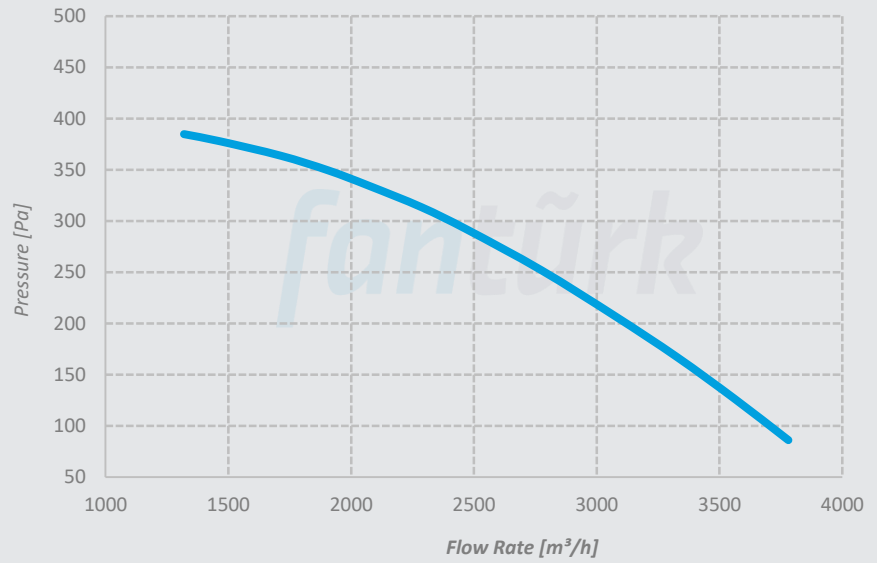

### ÇTF 280/0,55

Voltage 380 V  
Frequency 50 Hz  
Motor Power 0,55 kW  
Motor Speed 1370 rpm  
Sound Pressure Level 64 dBA  
Weight 60 kg

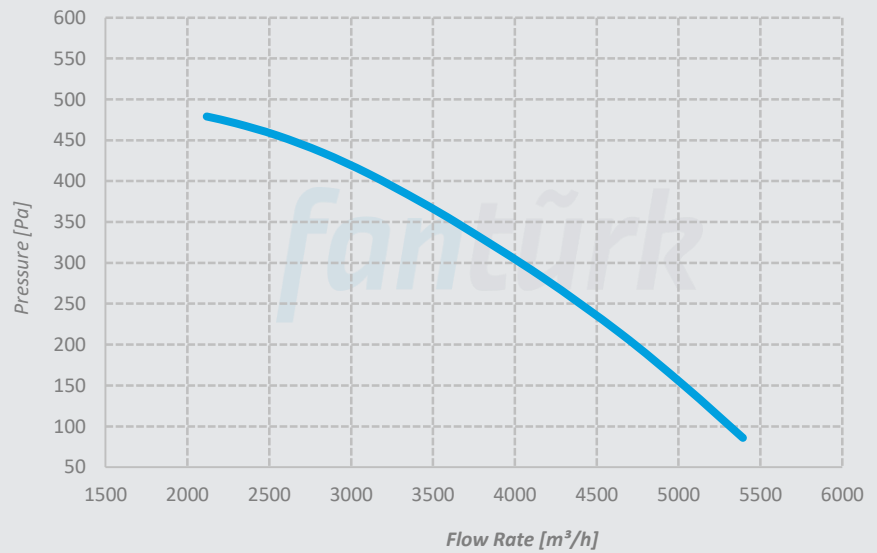

### ÇTF 315/1,1

Voltage 380 V  
Frequency 50 Hz  
Motor Power 1,1 kW  
Motor Speed 1390 rpm  
Sound Pressure Level 67 dBA  
Weight 70 kg

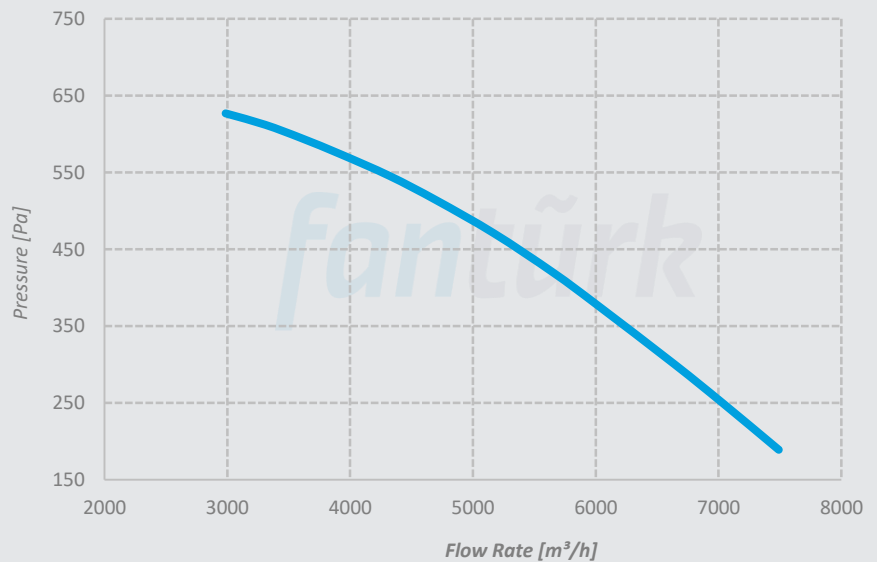

## Performance Curves

### ÇTF 355/2,2

Voltage 380 V  
Frequency 50 Hz  
Motor Power 2,2 kW  
Motor Speed 1420 rpm  
Sound Pressure Level 69 dBA  
Weight 80 kg

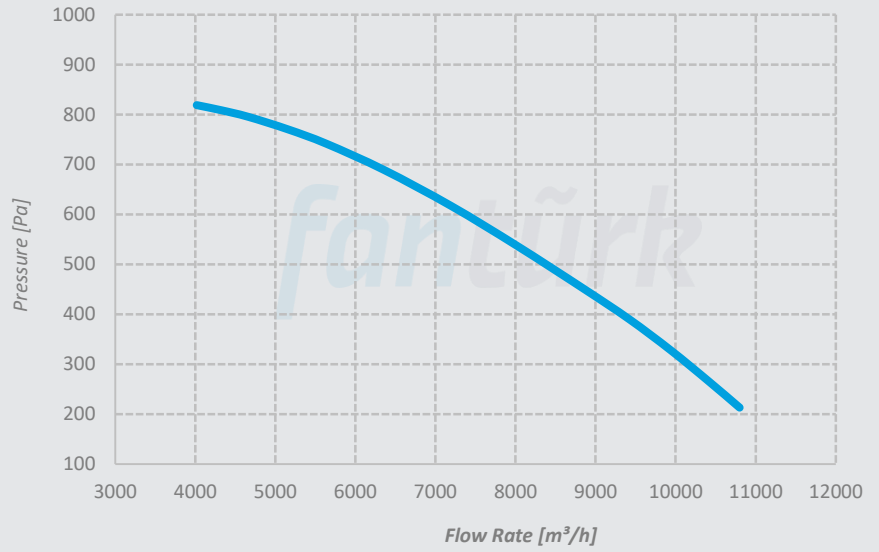

### ÇTF 400/1,1

Voltage 380 V  
Frequency 50 Hz  
Motor Power 1,1 kW  
Motor Speed 930 rpm  
Sound Pressure Level 60 dBA  
Weight 85 kg

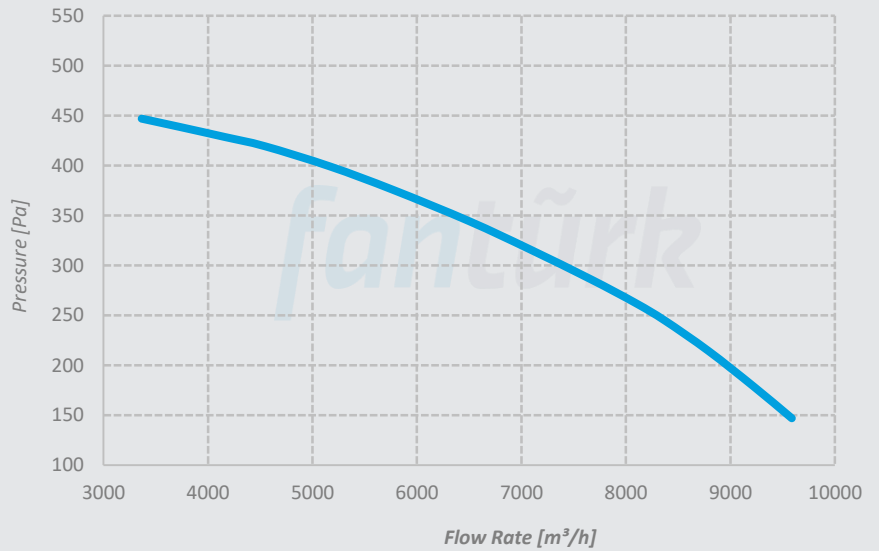

### ÇTF 400/4

Voltage 380 V  
Frequency 50 Hz  
Motor Power 4 kW  
Motor Speed 1430 rpm  
Sound Pressure Level 70 dBA  
Weight 105 kg

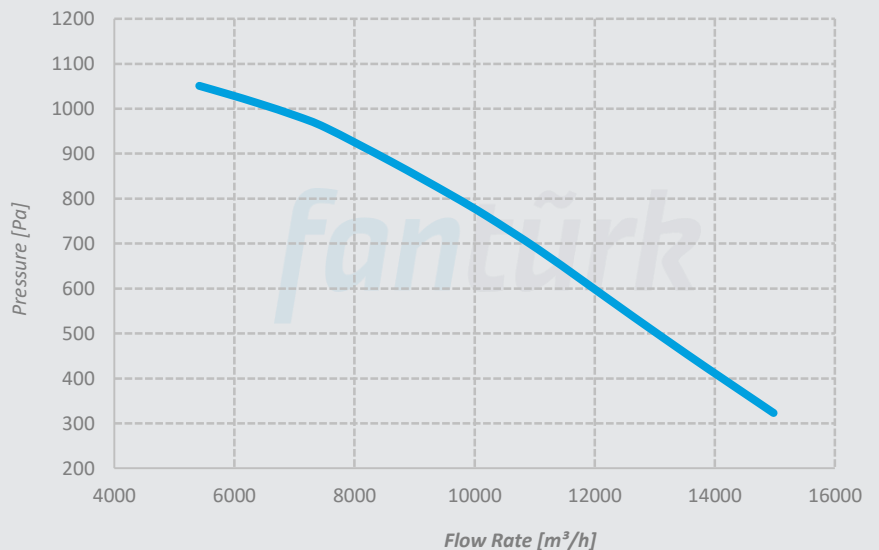



## Performance Curves

### ÇTF 450/2,2

Voltage 380 V  
Frequency 50 Hz  
Motor Power 2,2 kW  
Motor Speed 950 rpm  
Sound Pressure Level 63 dBA  
Weight 130 kg

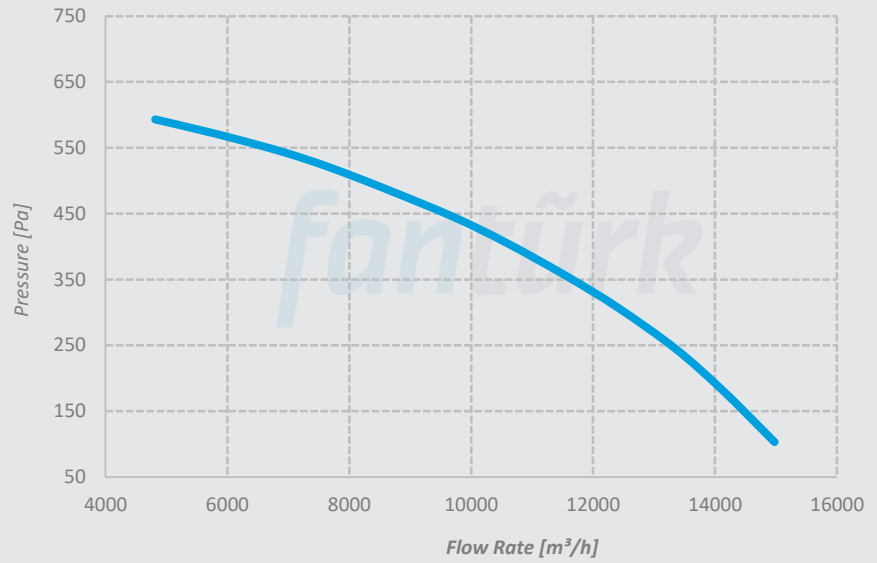

### ÇTF 450/5,5

Voltage 380 V  
Frequency 50 Hz  
Motor Power 5,5 kW  
Motor Speed 1440 rpm  
Sound Pressure Level 71 dBA  
Weight 130 kg

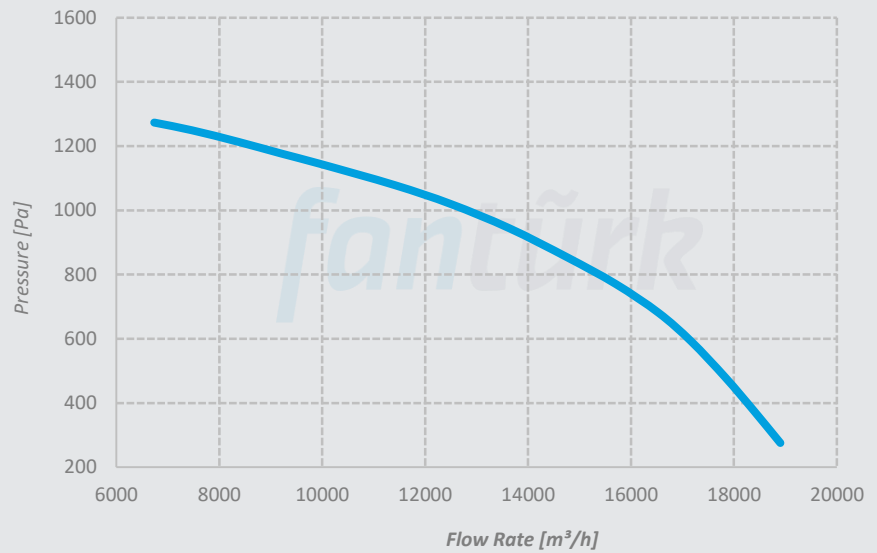

### ÇTF 450/7,5

Voltage 380 V  
Frequency 50 Hz  
Motor Power 7,5 kW  
Motor Speed 1450 rpm  
Sound Pressure Level 72 dBA  
Weight 151 kg

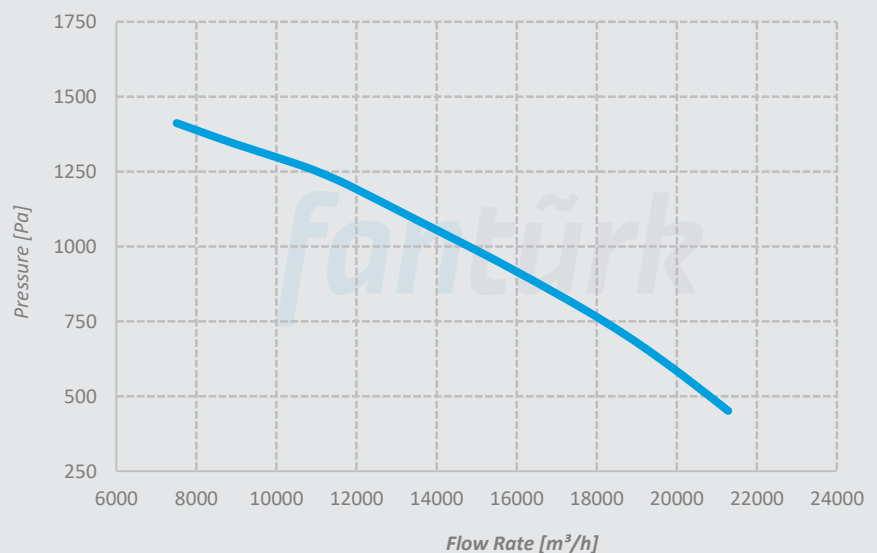



# Ç-FWA Roof Type Axial Fan

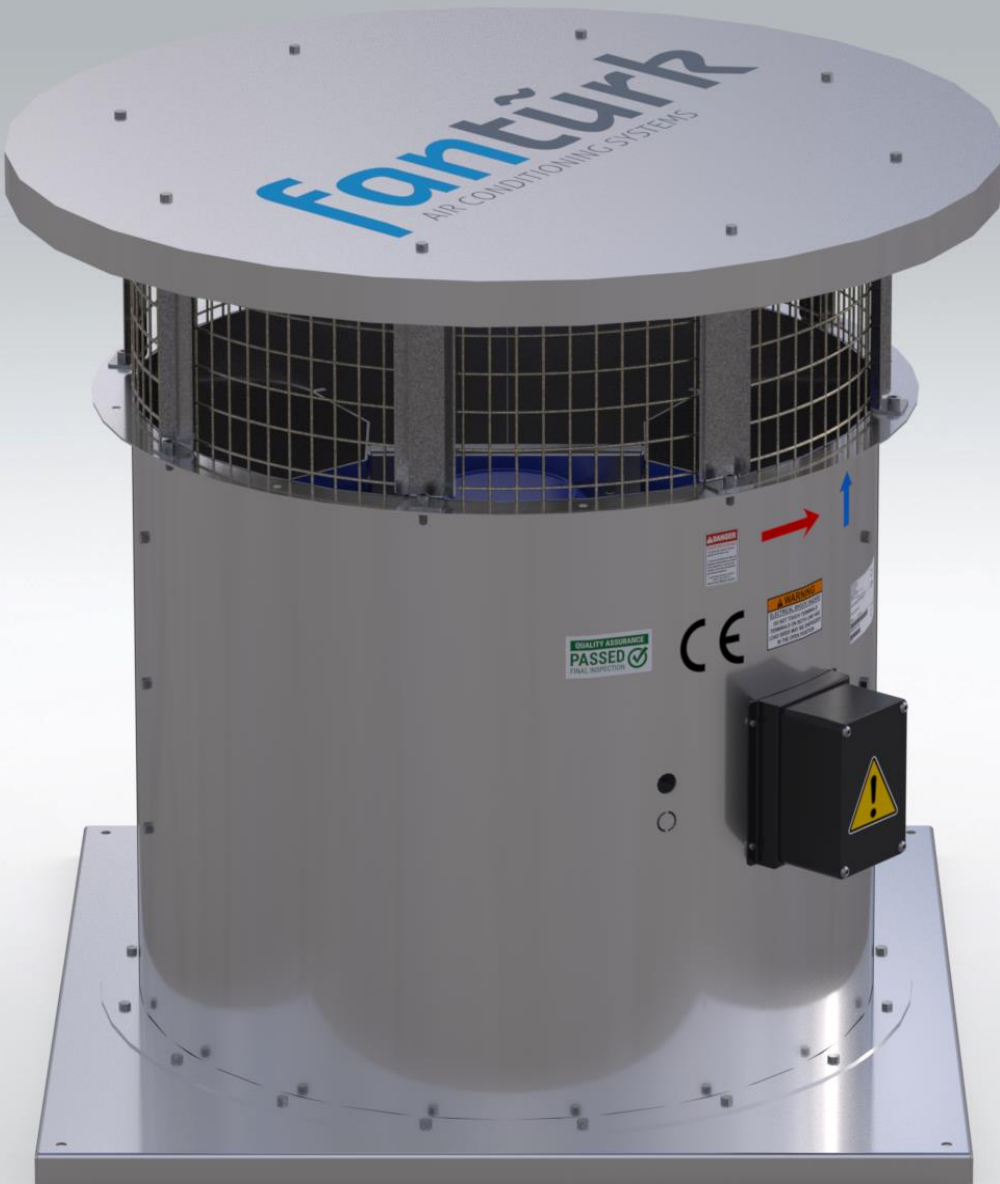

## Technical Specifications

# ROOF TYPE AXIAL FAN

Ç-FWA series roof type axial fans are the ideal fans for roof installation for ventilation systems where high air flow is required. Thanks to their compact construction, they can be mounted directly on the roof floor. Ç-FWA axial fans can be used not only for fresh air and exhaust ventilation, but also for smoke extraction applications. With wide selection of models, Ç-FWA models offer working range of 4000 m<sup>3</sup>/h – 140.000 m<sup>3</sup>/h in different pressure range.

It is manufactured between Ø400 mm and Ø1250 mm diameters. The body is made of high quality, corrosion-resistant galvanized steel. The propellers are made of special aluminum alloy with adjustable blade angles. It is manufactured as standard (380V-50Hz) or suitable for use at other voltages and frequencies upon demand. Class F, S1, IP55 single speed or double speed motors are used. In addition to the normal motor option, Ex-Proof and Smoke Exhaust (F300/2h, F400/2h) options are available. With optional silencer can be added to reduce the sound pressure level.

### Usage Areas

Can be used in all kinds of industrial building, office, shopping mall, hospital, factory, parking and residential building ventilation systems.

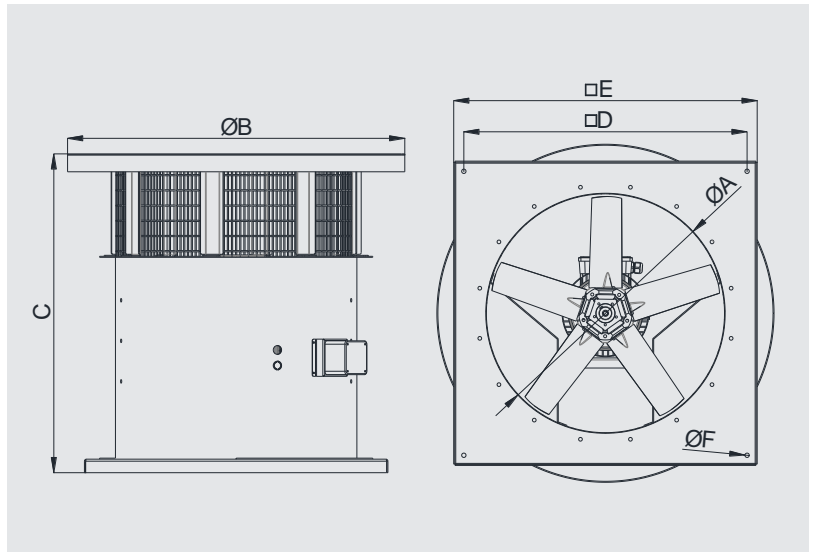
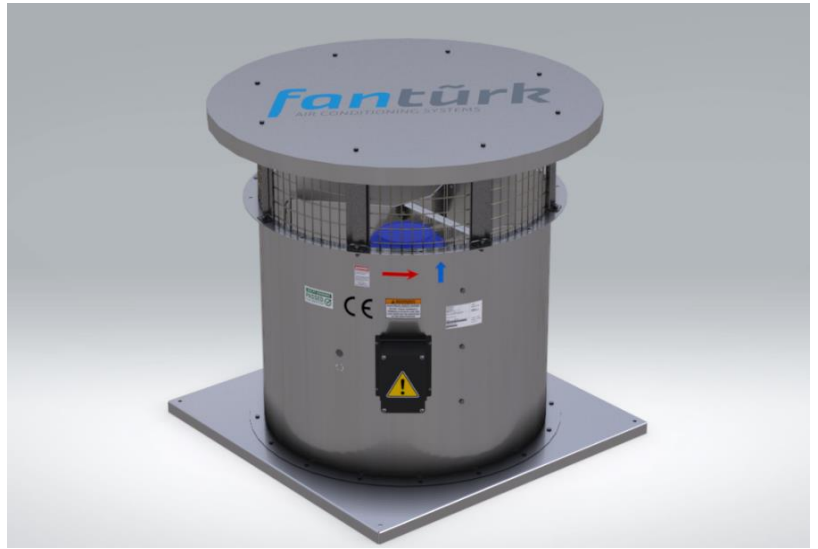

MODEL	A	B	C	D	E	F	VOLTAGE	FREQUENCY
	mm	mm	mm	mm	mm	mm	V	Hz
Ç-FWA 400	400	700	795	540	600	13	380	50
Ç-FWA 450	450	750	795	590	650	13	380	50
Ç-FWA 500	500	800	895	640	700	13	380	50
Ç-FWA 560	560	850	895	690	750	13	380	50
Ç-FWA 630	630	930	895	770	830	13	380	50
Ç-FWA 710	710	1000	945	840	900	13	380	50
Ç-FWA 800	800	1100	945	940	1000	13	380	50
Ç-FWA 900	900	1200	1095	1040	1100	13	380	50
Ç-FWA 1000	1000	1300	1195	1140	1200	13	380	50
Ç-FWA 1120	1120	1490	1453	1260	1320	13	380	50
Ç-FWA 1250	1250	1490	1453	1340	1400	13	380	50



# IGK Heat Recovery Unit

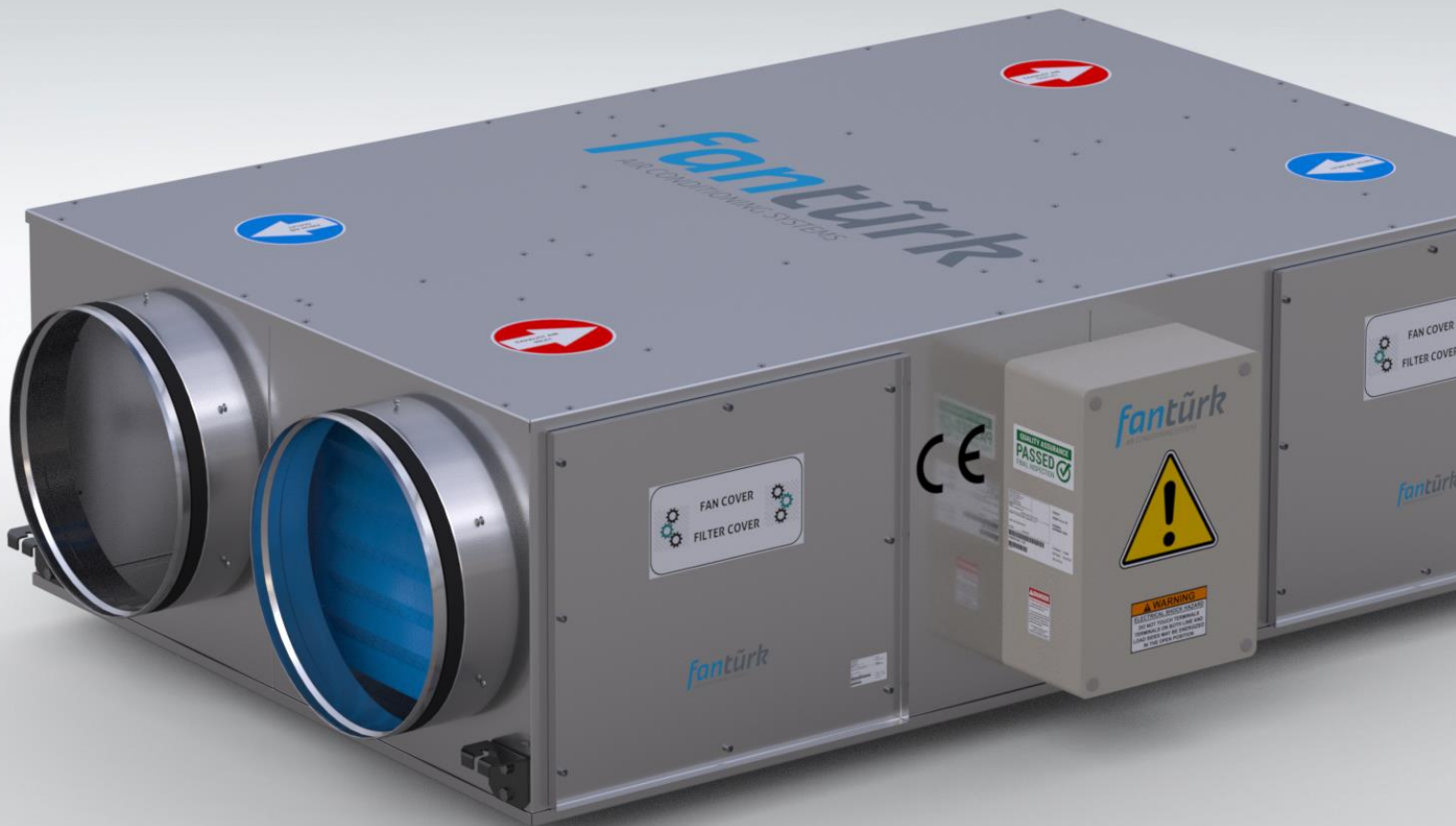

## General Features

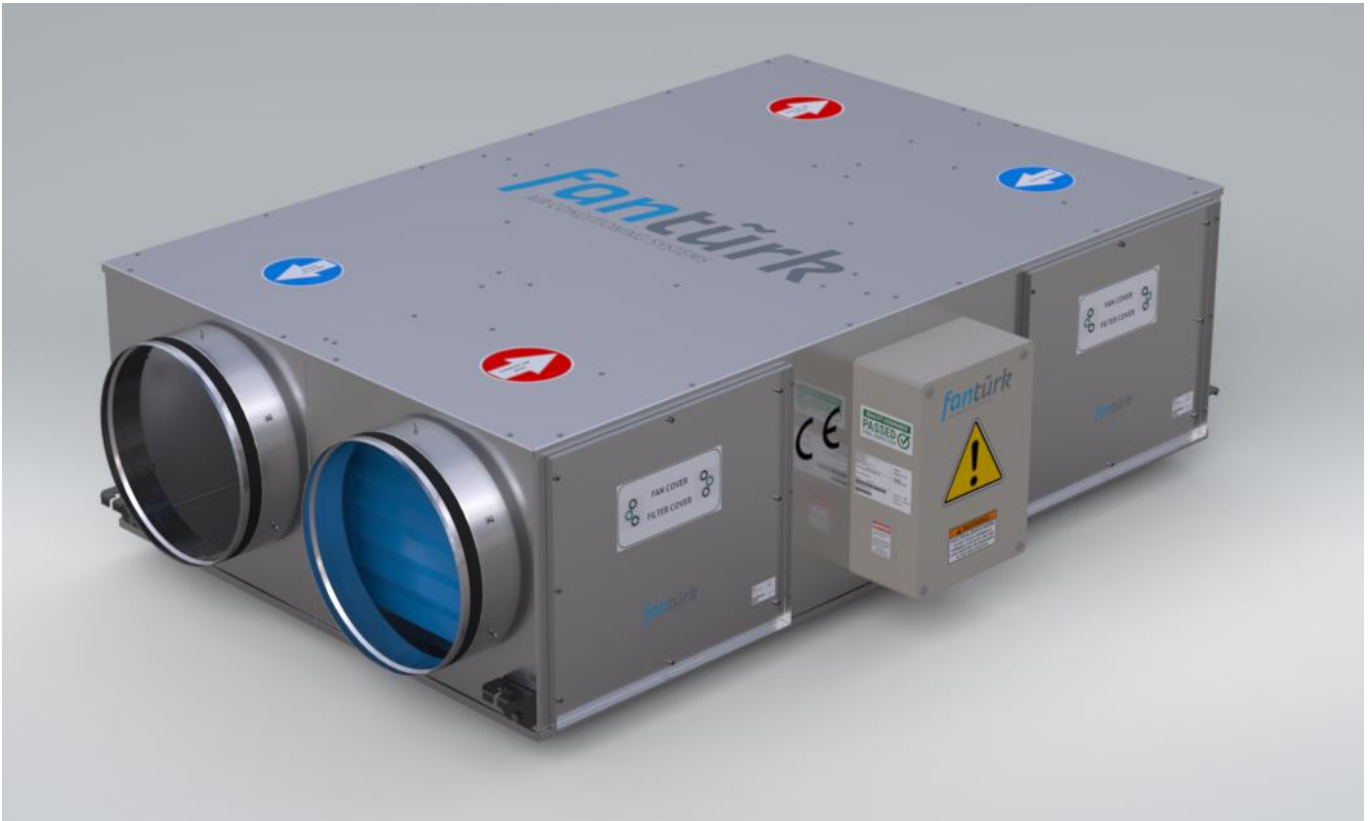

- For lower energy consumption, high efficient backward curved radial fans.
- High thermal efficient aluminum plate recuperators,
- Low noise level,
- High static pressure,
- G4 filter,
- Stepless speed control,
- Electric heater, DX heat exchanger, water coils can be integrated.
- Optional duct type circular attenuator for easy installation
- Optional intelligent automation solutions

Quiet & High Efficient



## Working System

Low-quality indoor air is produced in areas that are air-conditioned by heating or cooling, where carbon dioxide and other harmful gases are concentrated.

While this air is being exhausted, the heat load it carries is collected in the plate recuperator of the IGK -Heat Recovery Unit and the in-take fresh air is conditioned.

Thus, it is possible to recover the heat load in this air by 50-60% while the poor indoor air is discharged.

IGK— Heat Recovery Units are quiet and high efficient with plug fan motors on them.

The device can be operated at the desired flow rate with the speed controller sent as standard.

### Material

IGK-Heat Recovery Unit consists of 6 main parts.

-Case (1) is made of galvanized steel. 9mm rubber insulation and sound and heat insulation is provided.

-Fresh air and exhaust fans are radial fans with backward curved blades (2) For blade material Aluminum, Galvanized or Plastic can be selected.

-Service Covers (3) are located on the casing to easily carry out the maintenance with the fans and filters. By means of these covers, the fans can be easily removed in case of maintenance or failure.

-G4 filter (4) is available in both exhaust and fresh air inlets of the device.

-In this way, the main equipment of the device, Aluminum Plate Recuperator (5) is kept clean and working efficiently.

-In order to make the cable connection of the device easily, the Electrical Connection Box (6), which has the terminal connections of the fans, is fixed on the case.

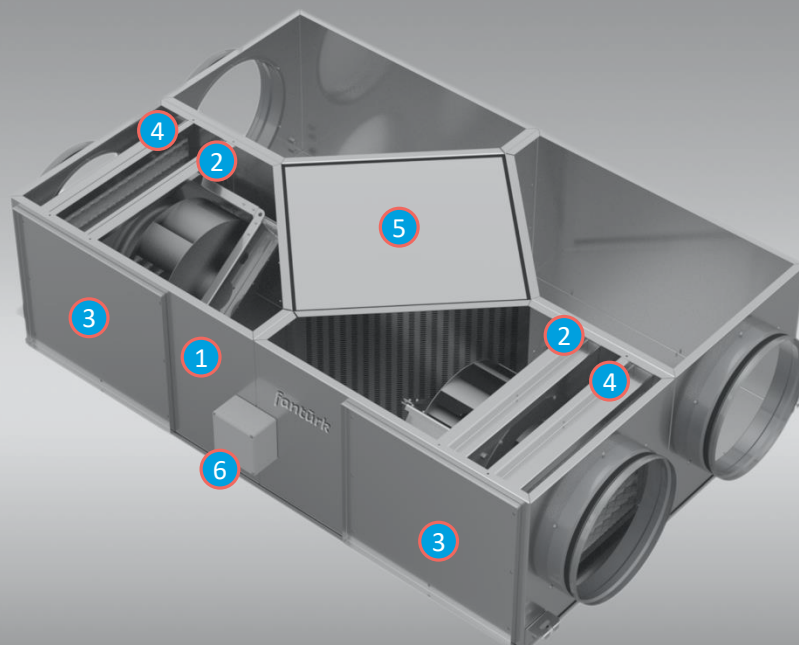

## Cihaz Ekipmanları

### PLUG FAN AC

- Backward Curved Blades
- High efficiency
- Low power consumption
- Low noise level
- High static pressure
- Thermo protection element against overheating of the motor
- Easy to remove and service thanks to the service cover.



### PLUG FAN EC (Optional)

In addition to AC fan features, EC fans

- Quieter
- More flow rate at lower power
- More efficiency
- Easier control



### HEAT RECOVERY RECUPERATOR

Plate Type

- Long life aluminum plate type recuperator
- High sensible heat transfer efficiency
- Sound damping feature
- Easy to remove and service thanks to service cover
- Washability
- Eurovent certificate

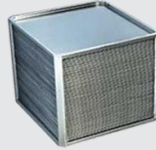
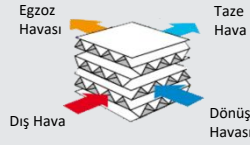

### HEAT RECOVERY RECUPERATOR (Optional)

Rotary Type

- Higher flow rate, lower pressure drop
- More efficiency
- Possibility of transferring latent heat.
- Very low risk of freezing.

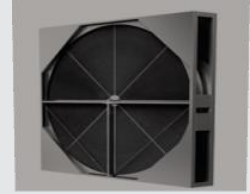
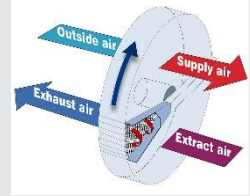

### Speed Switch

- Glass Safety Fuse
- Electronic Potentiometer
- Infinite speed adjustment between minimum and maximum voltage range



### Digital Control Panel & Panel Box (Optional)

- Offers many available functions and external sensor connectivity.



### Other optional features

- IGK with Water Coil
- IGK with By-Pass Feature
- Heat Pump IGK

## Control Panel

- Automatic or Manual program selection
- Easy to use with ready-made scenarios
- Possibility to integrate with electric heater, DX battery, water coils systems
- Possibility to use Modbus system
- Fresh air and exhaust fan speed adjustment
- Additional heating equipment adjustment
- Ventilation under continuous comfort conditions with integrated room thermostat



### Available Functions

- Single Motor Speed Fan Proportional Speed Control
- Fan Speed Control with Three Motor Speed \*
- EC Fan Control (0-10V) \*
- Electric Heater Control
- Preheater Control \*
- Air Quality and CO2 Control
- Proportional Heating / Cooling Control \*
- On / Off Heating / Cooling Control
- By-Pass Damper Control \*
- DX Battery Frost Protection \*
- Recuperator Freezing Control
- Compressor Control \*
- Filter Pollution Control
- Remote Control
- Weekly Calendar
- Modbus RTU Communication \*
- BACnet MS / TP Communication \*

\* Marked functions required must be specified separately when ordering.

### External Sensor Connections

- Return Air Sensor
- Supply Air Sensor
- Fresh Air Sensor
- Exhaust Air Sensor
- Air Quality Sensor
- CO2 Sensor
- Humidity Sensor \*



## Technical Specifications

# HEAT RECOVERY UNIT

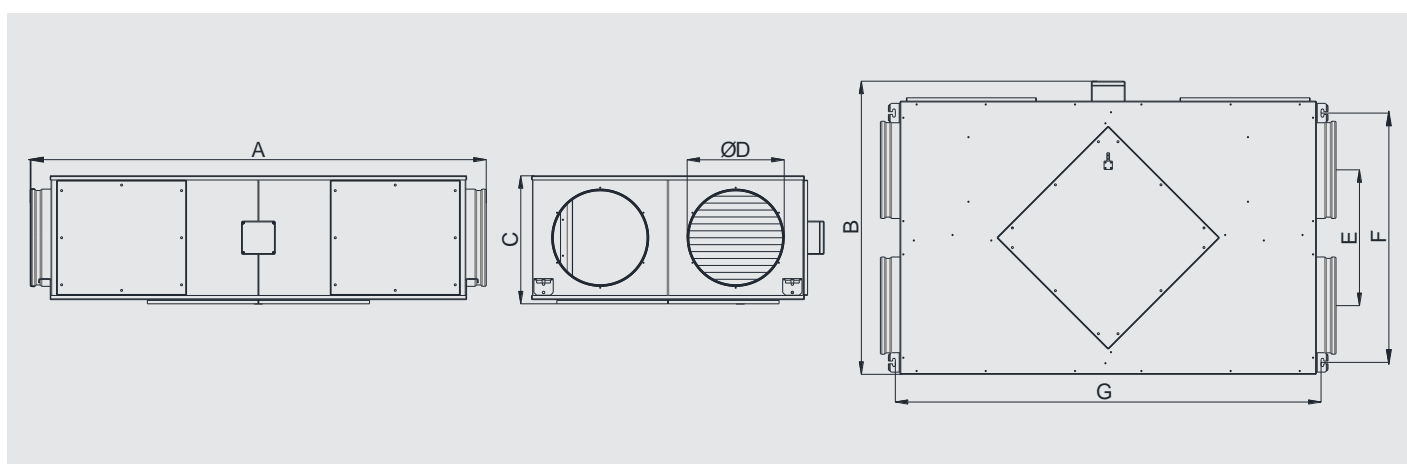
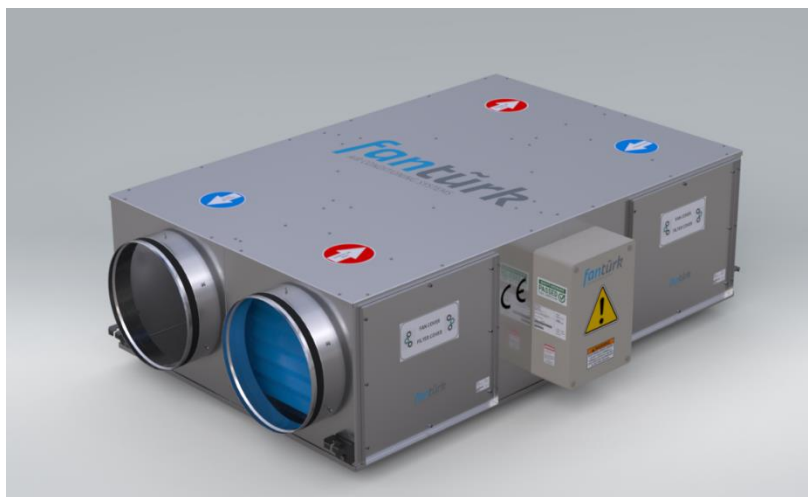

MODEL	A	B	C	ØD	E	F	G	FLOW RATE	VOLTAGE	FREQUENCY	MOTOR POWER	CURRENT	CAPACITOR	MOTOR SPEED	SOUND P. LEVEL	WEIGHT
	mm	mm	mm	mm	mm	mm	mm	m <sup>3</sup> /h	V	Hz	W	A	µf	rpm	dBa	kg
IGK 500	1010	790	320	196	300	520	880	570	230	50	2x76	2x0,29	2x2,5	2350	52	35
IGK 750	1094	845	370	196	325	575	985	925	230	50	2x100	2x0,47	2x3	2580	56	45
IGK 1000	1280	910	370	246	360	640	1170	1150	230	50	2x160	2x0,68	2x4	2600	63	55
IGK 1500	1280	990	400	246	400	720	1170	1800	230	50	2x180	2x0,8	2x4	2700	58	60
IGK 2000	1390	1170	460	276	490	905	1280	2300	230	50	2x285	2x1,5	2x5	2500	76	105
IGK 3000	1660	1170	460	350	490	900	1550	4000	230	50	2x272	2x1,23	2x8	1364	72	130
IGK 4000	2060	1405	630	396	605	1130	1950	6000	230	50	2x500	2x1,8	2x12	1380	61	165
IGK 5000	2100	1485	690	446	645	1210	1990	8200	230	50	2x800	2x3,7	2x16	1359	62	210
IGK 6500	2105	1485	690	496	645	1210	1990	4200	230	50	2x1550	2x6,8	2x31	1380	72	210

## Duct Type Electric Heater

- TSEK Quality Certificate and CE mark.
- Used in the outlet of heat recovery unit in cold climates and in fresh air in-take against freezing in very cold climates.
- Can be designed single, double or triple step according to customer needs.
- Can be produced as galvanized or stainless steel body according to the project requirements.
- It has limit overtemperature circuit to be activated at 70 ° C and reset overtemperature circuit to be activated at 110 ° C.

MODEL	IGK 500	IGK 750	IGK 1000	IGK 1500	IGK 2000	IGK 3000	IGK 4000	IGK 5000	IGK 6500
ØD	Ø200	Ø200	Ø250	Ø250	Ø280	Ø350	Ø400	Ø450	Ø500
Capacity	2 kW	3 kW	5 kW	5 kW	5 kW	8 kW	10 kW	13 kW	15 kW

### Motor Power Range of Round Duct Type Electric Heater

Min. 1 kW – Max. 15 kW

### Dimensions of Round Duct Type Electric Heater

Ød: Min. 200 mm / Max. 500 mm

L: Standart 380 mm

A: Standart 263 mm

B: Min. 187 mm / Max. 312 mm

C: Standart 130 mm

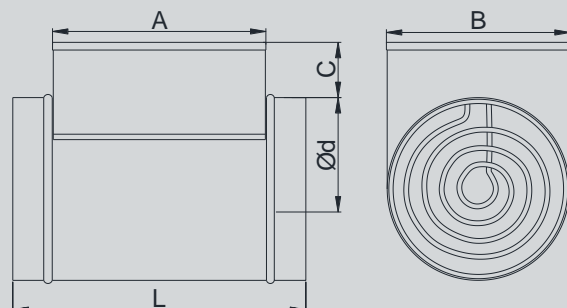

## Performance Curves

### IGK 500

**Flow Rate** 570 m<sup>3</sup>/h  
**Voltage** 230 V  
**Frequency** 50 Hz  
**Motor Power** 2x76 W  
**Current** 2x0,29 A  
**Capacitor** 2x2,5 µf  
**Motor Speed** 2350 rpm  
**Sound Pressure Level** 52 dBA  
**Weight** 35 kg  
**Electric Heater** 2kW

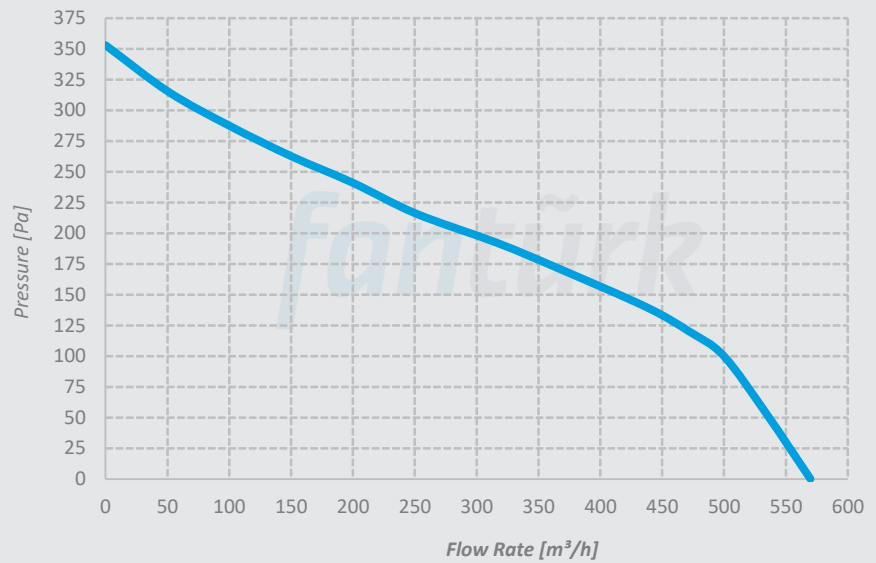

### IGK 750

**Flow Rate** 925 m<sup>3</sup>/h  
**Voltage** 230 V  
**Frequency** 50 Hz  
**Motor Power** 2x100 W  
**Current** 2x0,47 A  
**Capacitor** 2x3 µf  
**Motor Speed** 2580 rpm  
**Sound Pressure Level** 56 dBA  
**Weight** 45 kg  
**Electric Heater** 3 kW

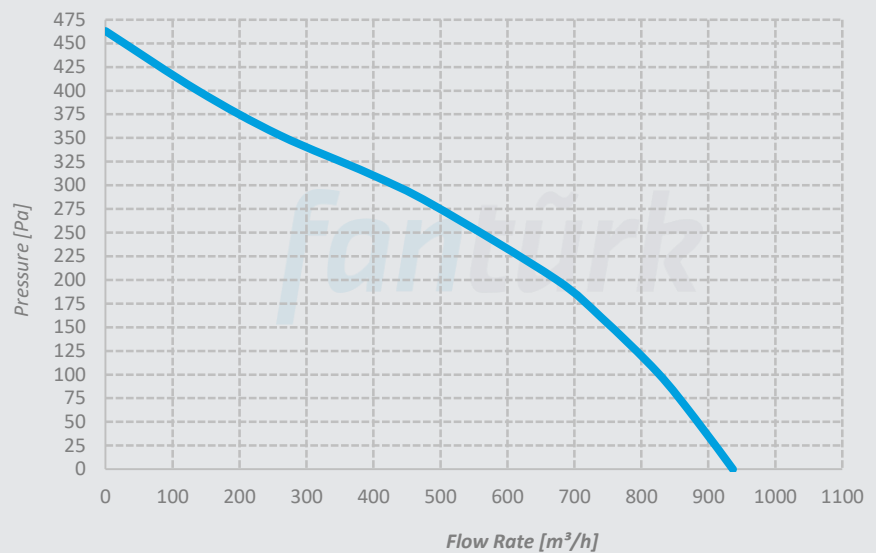

### IGK 1000

**Flow Rate** 1150 m<sup>3</sup>/h  
**Voltage** 230 V  
**Frequency** 50 Hz  
**Motor Power** 2x160 W  
**Current** 2x0,68 A  
**Capacitor** 2x4 µf  
**Motor Speed** 2600 rpm  
**Sound Pressure Level** 63 dBA  
**Weight** 55 kg  
**Electric Heater** 5 kW

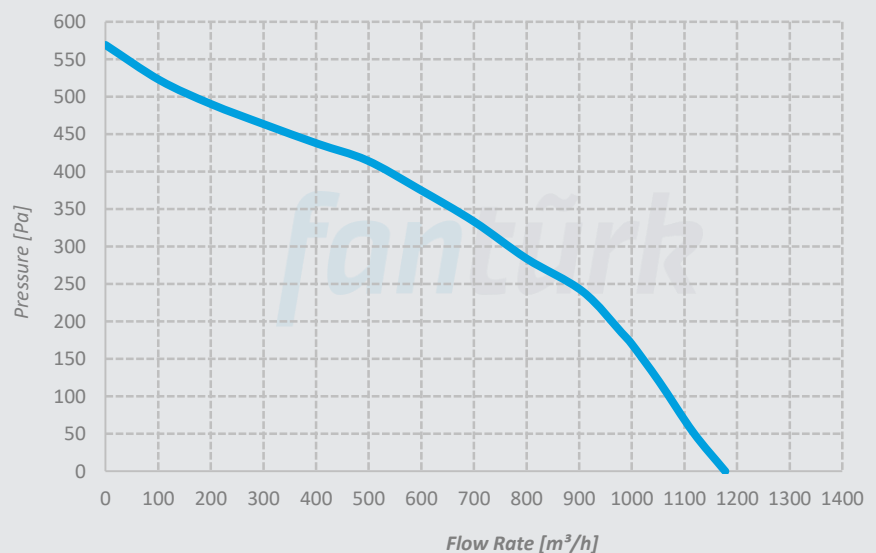

## Performance Curves

### IGK 1500

**Flow Rate** 1800 m<sup>3</sup>/h  
**Voltage** 230 V  
**Frequency** 50 Hz  
**Motor Power** 2x180 W  
**Current** 2x0,8 A  
**Capacitor** 2x4 µf  
**Motor Speed** 2700 rpm  
**Sound Pressure Level** 58 dBA  
**Weight** 60 kg  
**Electric Heater** 5 kW

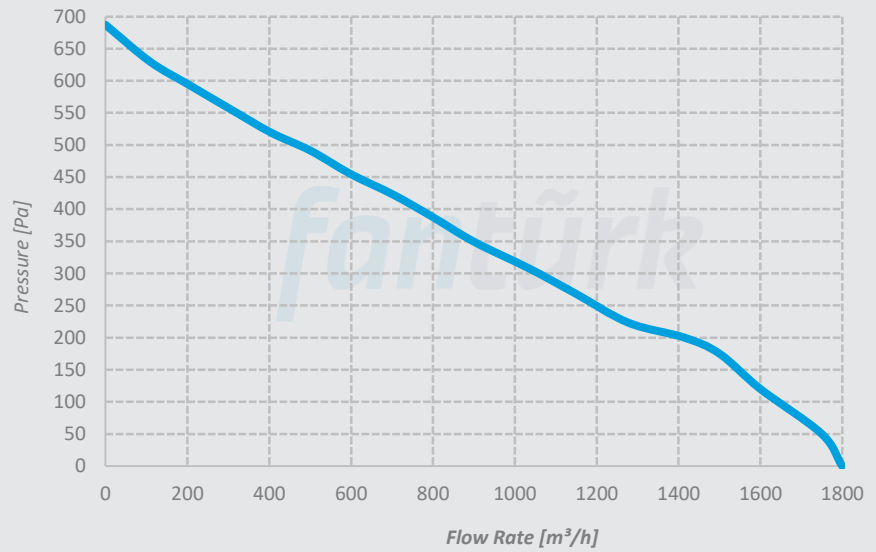

### IGK 2000

**Flow Rate** 2300 m<sup>3</sup>/h  
**Voltage** 230 V  
**Frequency** 50 Hz  
**Motor Power** 2x285 W  
**Current** 2x1,5 A  
**Capacitor** 2x5 µf  
**Motor Speed** 2700 rpm  
**Sound Pressure Level** 76 dBA  
**Weight** 105 kg  
**Electric Heater** 5 kW

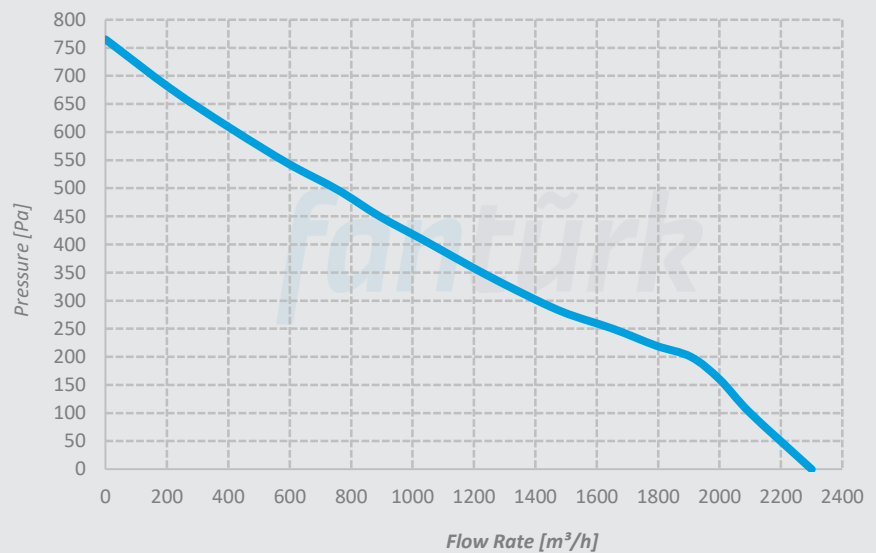

### IGK 3000

**Flow Rate** 4000 m<sup>3</sup>/h  
**Voltage** 230 V  
**Frequency** 50 Hz  
**Motor Power** 2x272 W  
**Current** 2x1,23 A  
**Capacitor** 2x8 µf  
**Motor Speed** 1364 rpm  
**Sound Pressure Level** 72 dBA  
**Weight** 130 kg  
**Electric Heater** 8 kW

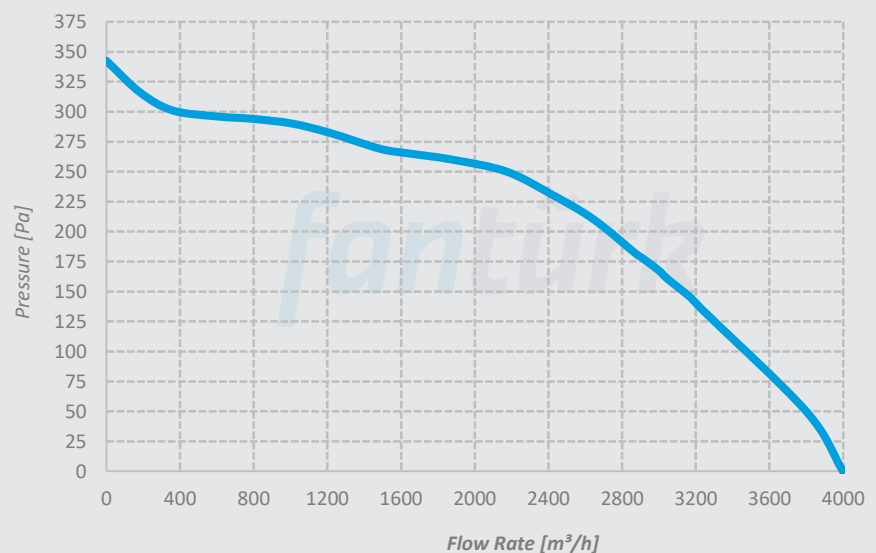

## Performance Curves

### IGK 4000

Flow Rate 4400 m<sup>3</sup>/h  
Voltage 230 V  
Frequency 50 Hz  
Motor Power 2x500 W  
Current 2x1,8 A  
Capacitor 2x12 µf  
Motor Speed 1380 rpm  
Sound Pressure Level 61 dBA  
Weight 165 kg  
Electric Heater 10 kW

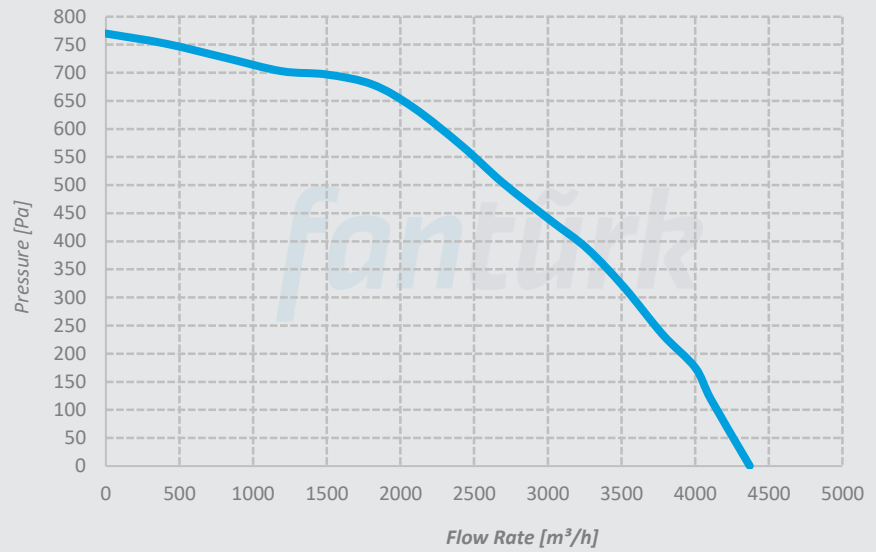

### IGK 5000

Flow Rate 6000 m<sup>3</sup>/h  
Voltage 230 V  
Frequency 50 Hz  
Motor Power 2x800 W  
Current 2x3,7 A  
Capacitor 2x16 µf  
Motor Speed 1359 rpm  
Sound Pressure Level 62 dBA  
Weight 210 kg  
Electric Heater 13 kW

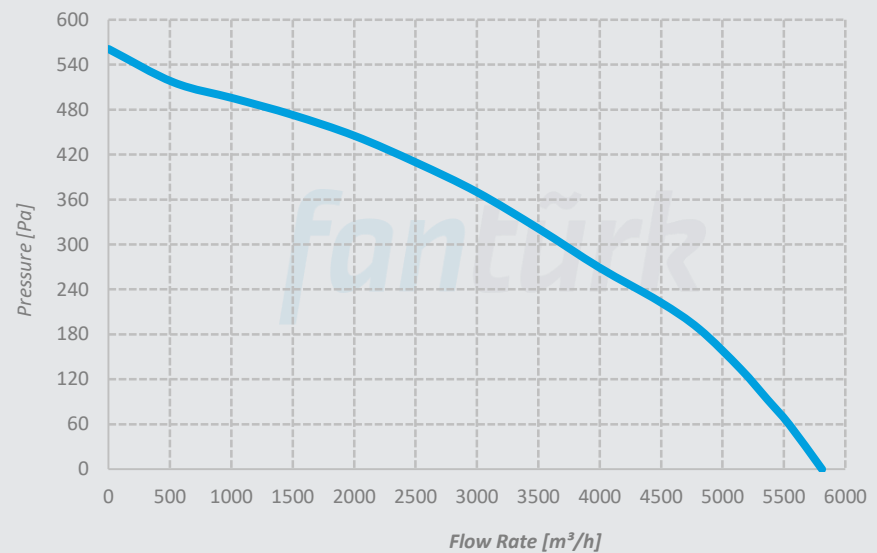

### IGK 6500

Flow Rate 8200 m<sup>3</sup>/h  
Voltage 230 V  
Frequency 50 Hz  
Motor Power 2x1550 W  
Current 2x6,8 A  
Capacitor 2x31 µf  
Motor Speed 1380 rpm  
Sound Pressure Level 72 dBA  
Weight 210 kg  
Electric Heater 15 kW

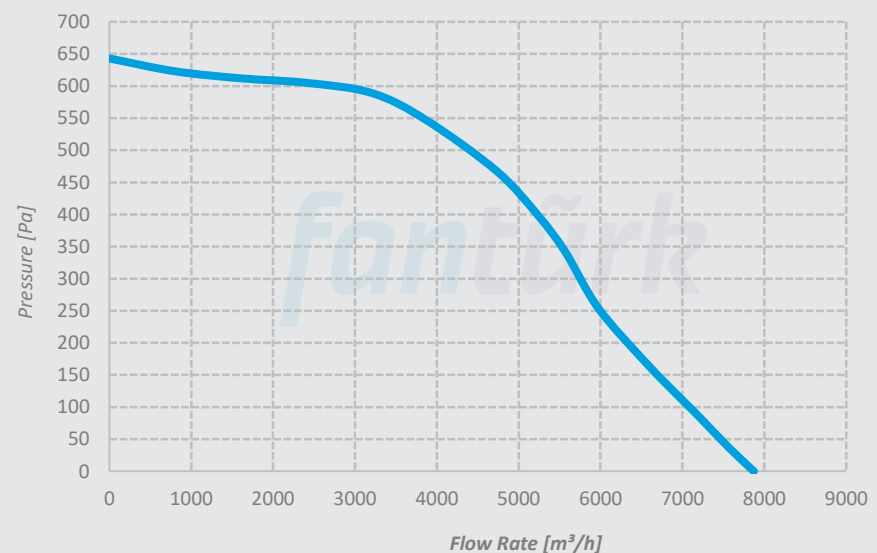



*ECO*  
*Compact*  
*Cabinet Type Fan*



## Technical Specifications

# ECO COMPACT CABINET TYPE FAN

ECO series fans are manufactured in high quality with low or high exhaust and fresh air capacity according to the characteristics of the ambient air to be used in order to refresh the ambient air in places where heating and cooling are not desired.

The body is made of high quality corrosion-resistant galvanized steel. The inner skin is completely covered with 6mm rubber insulation. The fans are double inlet radial fans with forward curved blades. The motor is mounted on the fan. The fan driven with pulley-belt system. In this way, the fan speed can be adjusted to meet the operating conditions optimally.

### Usage Areas

Can be used for ventilation systems in all kinds of workplaces, offices, cafeterias, markets, restaurants, meeting rooms, shopping malls, hospitals and industrial facilities.

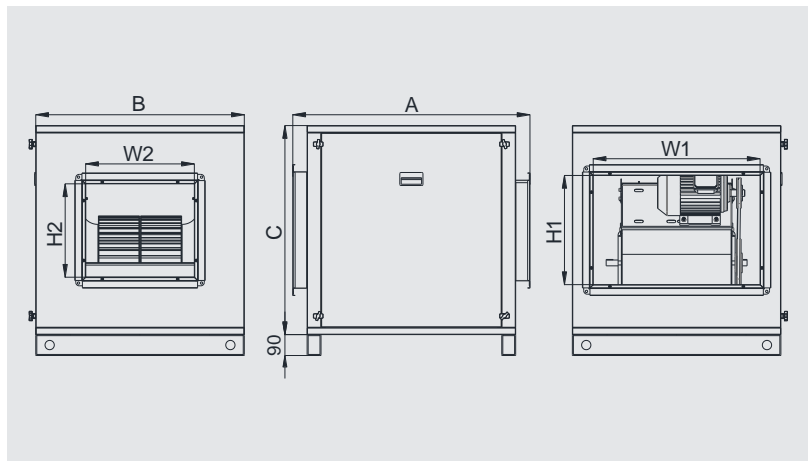
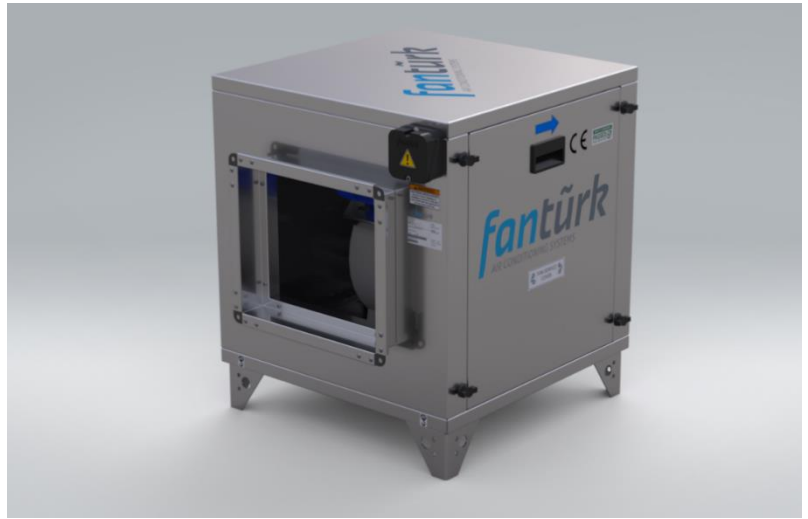

MODEL	A	B	C	Inlet W1xH1	Outlet W2xH2	FLOW RATE	EXTERNAL PRESSURE	STATIC PRESSURE	VOLTAGE	FREQUENCY	MOTOR POWER	MOTOR SPEED	WEIGHT
	mm	mm	mm	mm	mm	m <sup>3</sup> /h	Pa	Pa	V	Hz	kW	rpm	kg
ECO-1	720	600	600	350x300	268x241	2500	270	274	380	50	0,75	1370	43
ECO-2	820	600	600	400x350	336x296	3500	400	406	380	50	1,1	1380	48
ECO-3	920	700	700	500x400	369x325	5000	320	326	380	50	1,5	1385	55
ECO-4	920	800	800	500x500	432x377	7500	300	306	380	50	2,2	1405	65
ECO-5	1020	900	900	750x500	509x439	10000	400	411	380	50	3	1405	80
ECO-6	1170	1050	1050	800x600	592x515	12500	345	355	380	50	3	1405	170
ECO-7	1170	1050	1050	800x600	592x515	15000	294	308	380	50	4	1425	174
ECO-8	1170	1050	1050	800x600	592x515	17500	380	400	380	50	5,5	1430	185

## Performance Curves

### ECO-1

*Flow Rate* 2500 m<sup>3</sup>/h  
*External Pressure* 270 Pa  
*Static Pressure* 274 Pa  
*Motor Power* 0,75 kW  
*Motor Speed* 1370 rpm  
*Weight* 43 kg

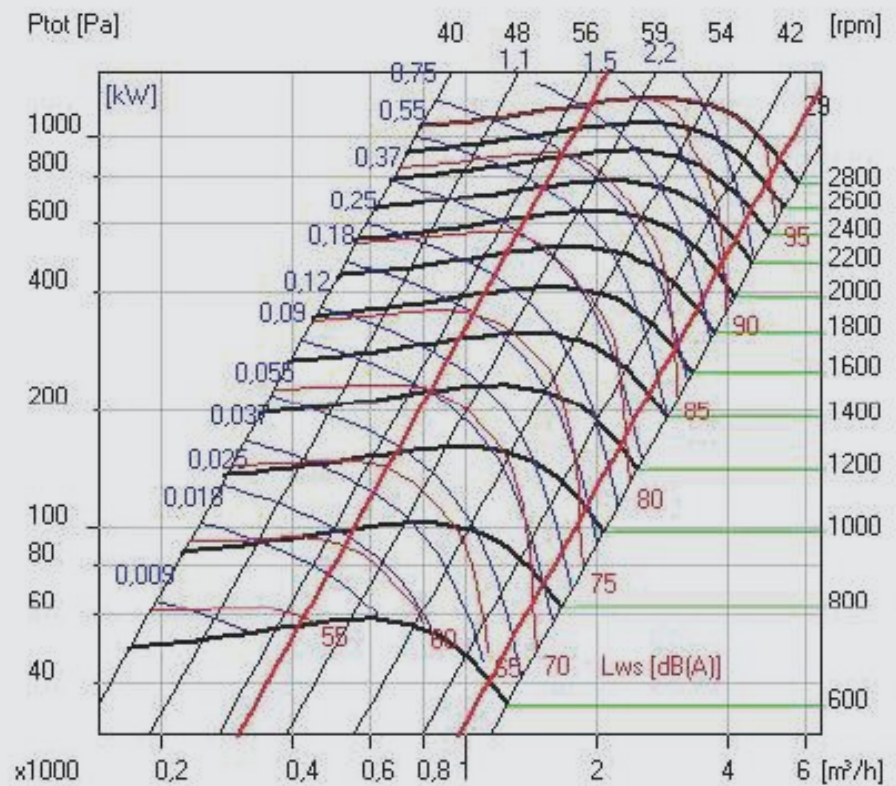

### ECO-2

*Flow Rate* 3500 m<sup>3</sup>/h  
*External Pressure* 400 Pa  
*Static Pressure* 406 Pa  
*Motor Power* 1,1 kW  
*Motor Speed* 1380 rpm  
*Weight* 48 kg

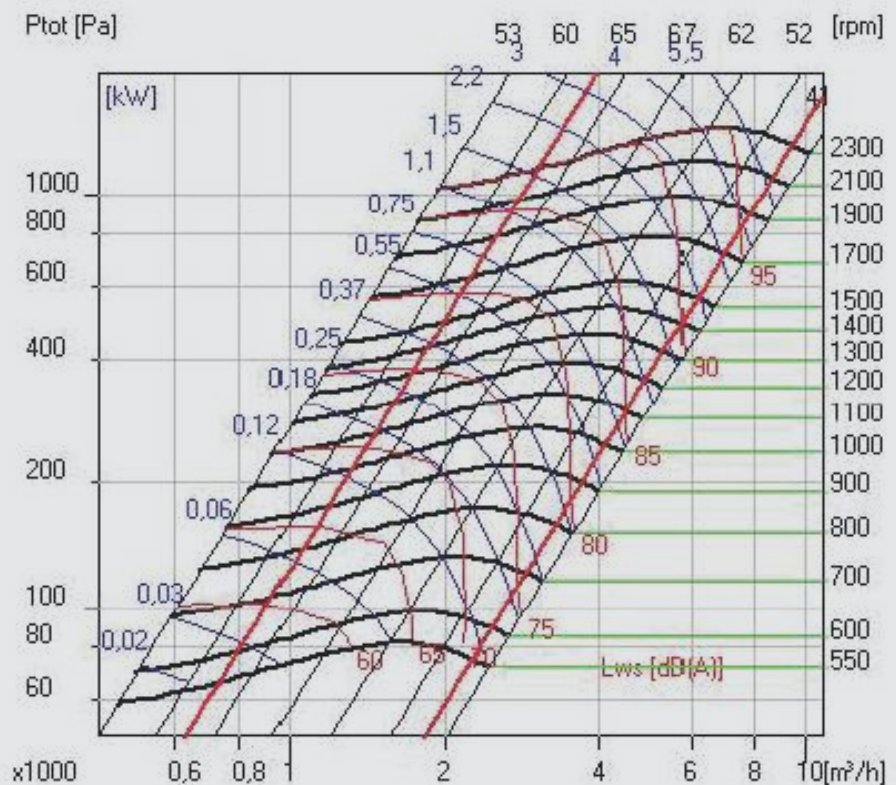



## Performance Curves

### ECO-3

*Flow Rate* 5000 m<sup>3</sup>/h  
*External Pressure* 320 Pa  
*Static Pressure* 326 Pa  
*Motor Power* 1,5 kW  
*Motor Speed* 1385 rpm  
*Weight* 55 kg

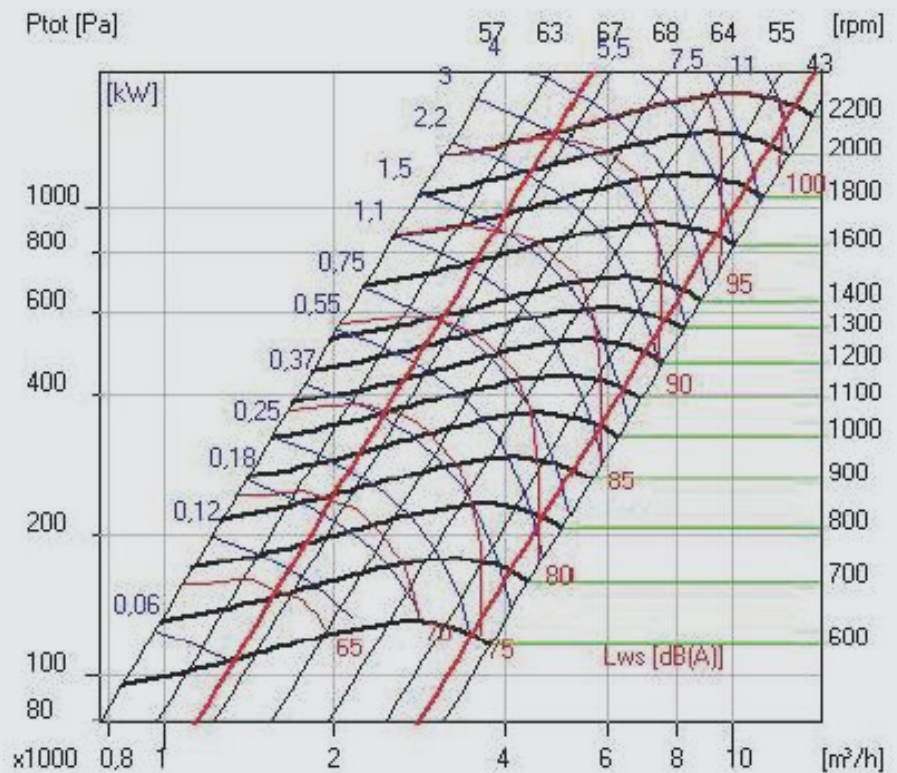

### ECO-4

*Flow Rate* 7500 m<sup>3</sup>/h  
*External Pressure* 300 Pa  
*Static Pressure* 306 Pa  
*Motor Power* 2,2 kW  
*Motor Speed* 1405 rpm  
*Weight* 65 kg

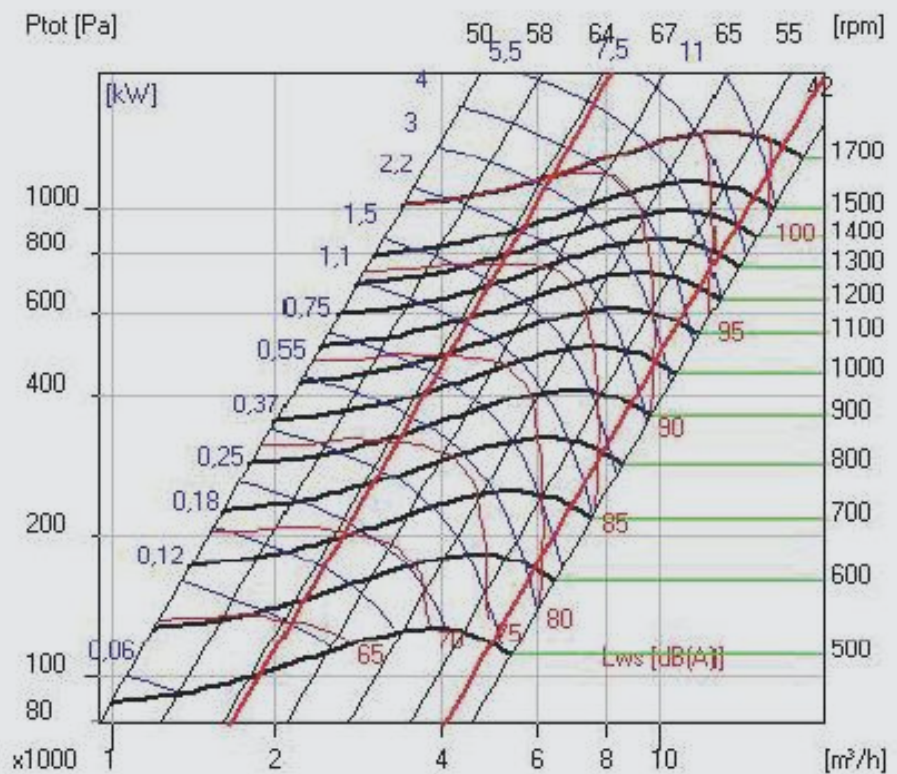

## Performance Curves

### ECO-5

*Flow Rate 10000 m<sup>3</sup>/h*  
*External Pressure 400 Pa*  
*Static Pressure 411 Pa*  
*Motor Power 3 kW*  
*Motor Speed 1405 rpm*  
*Weight 80 kg*

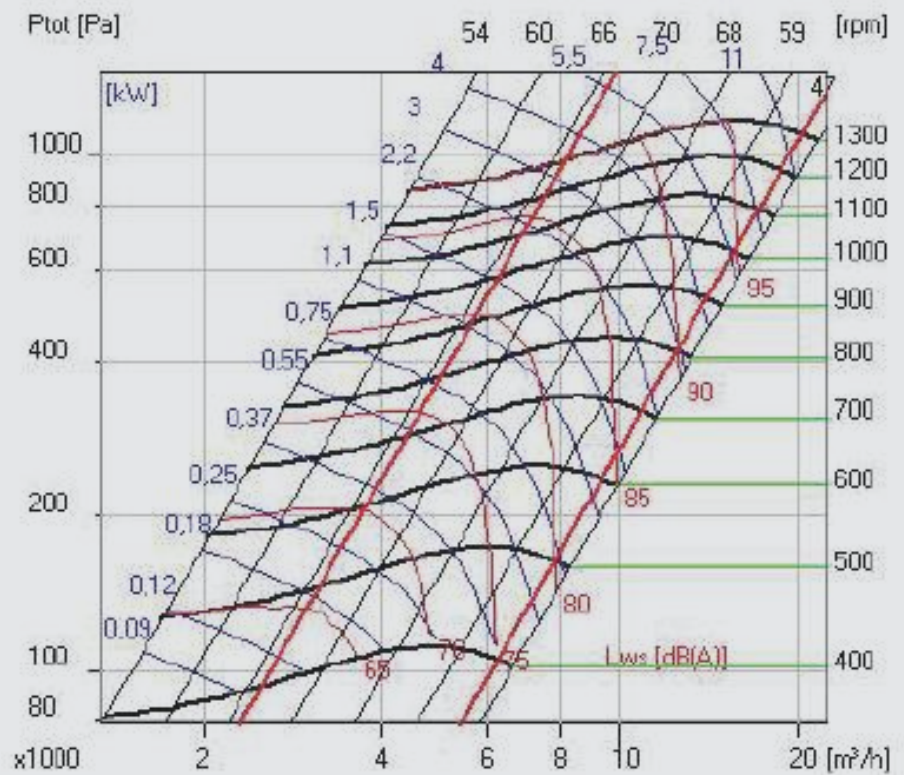

### ECO-6

*Flow Rate 12500 m<sup>3</sup>/h*  
*External Pressure 345 Pa*  
*Static Pressure 355 Pa*  
*Motor Power 3 kW*  
*Motor Speed 1405 rpm*  
*Weight 170 kg*

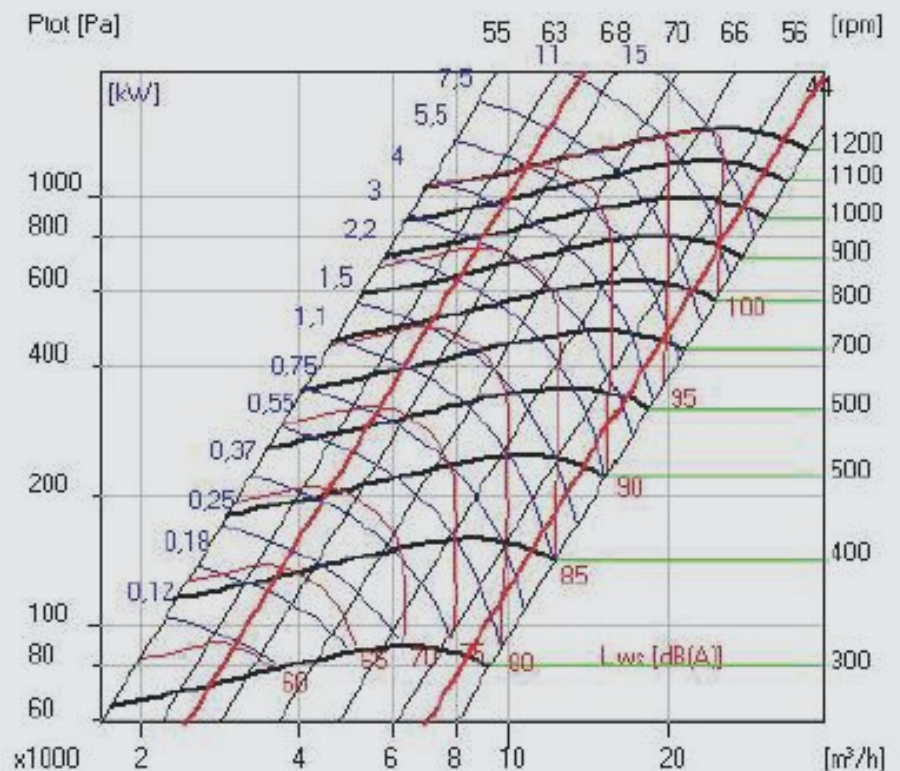

## Performance Curves

### ECO-7

*Flow Rate 15000 m<sup>3</sup>/h*  
*External Pressure 294 Pa*  
*Static Pressure 308 Pa*  
*Motor Power 4 kW*  
*Motor Speed 1425 rpm*  
*Weight 174 kg*

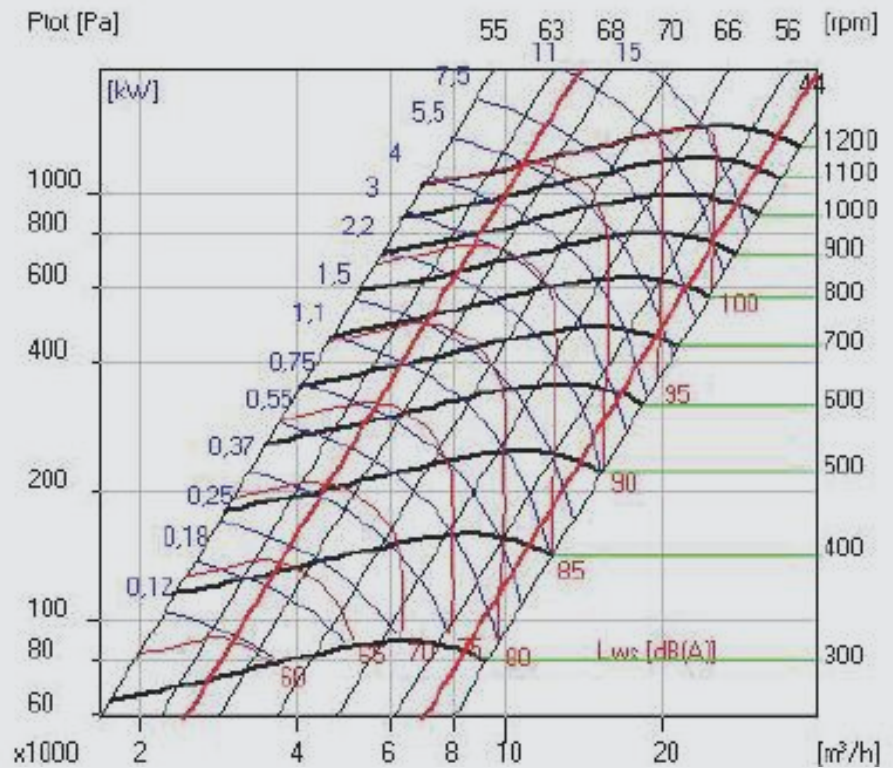

### ECO-8

*Flow Rate 17500 m<sup>3</sup>/h*  
*External Pressure 380 Pa*  
*Static Pressure 400 Pa*  
*Motor Power 5,5 kW*  
*Motor Speed 1430 rpm*  
*Weight 185 kg*

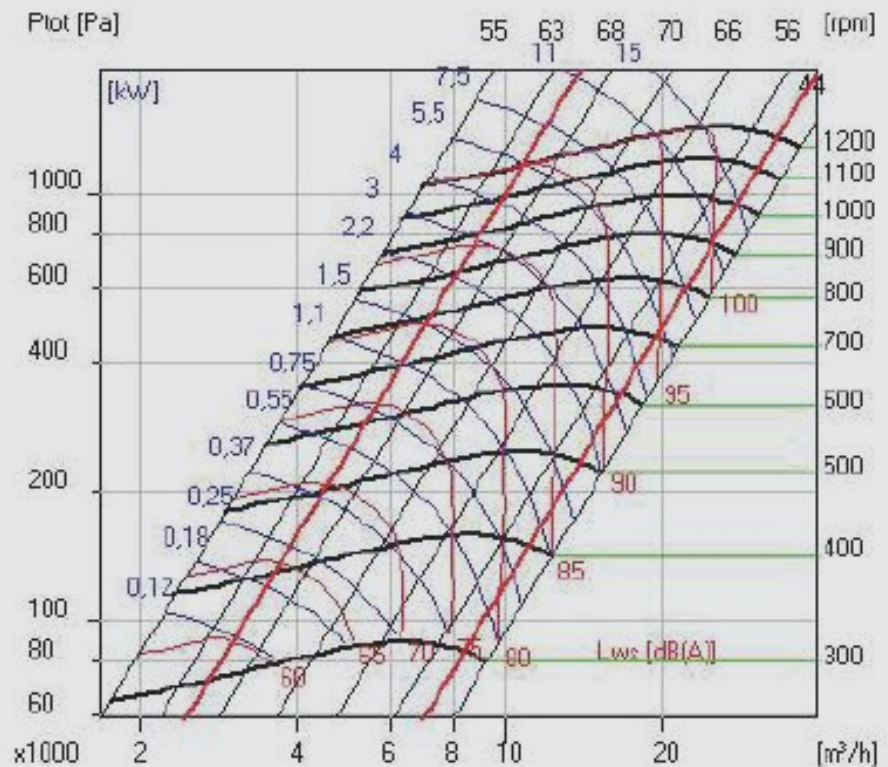



**M-HA**  
**Cabinet Type Kitchen**  
**Aspirator with Metal**  
**Filter**



## Technical Specifications

# CABINET TYPE KITCHEN ASPIRATOR

M-HA series kitchen aspirators are the ideal devices to clean exhaust air taken from kitchens or cooker hoods. With G2 metal filter at the entrance and optionally electrostatic filter, cylindrical activated carbon filter, UV filter, it keeps the oil and soot particles in the suction air and clean the air to be thrown into the atmosphere.

Cabinet panels are isolated with 50mm thickness of rock wool. Inner skin is made of high quality corrosion-resistant galvanized steel. Outer skin is made of coated steel. The fans are radial fans with backward curved blades. To cover motor from oily and hot air, it is enclosed in a separate cell that has not affected from air flow. This increases the service life of the device and eliminates the risk of fire.

### Usage Areas

In industrial kitchens, restaurants, hotels, shopping centers, cooking areas, it is used to exhaust hot, oily air that emerges during cooking.

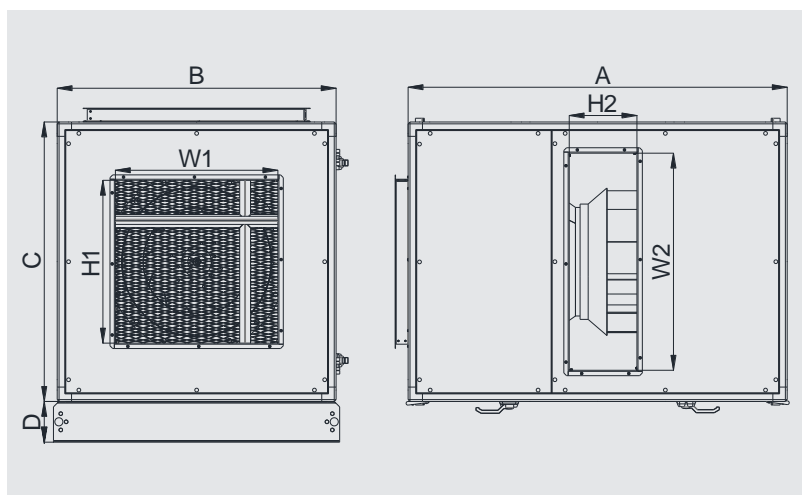

MODEL	A	B	C	D	Inlet W1xH1	Outlet W2xH2	FLOW RATE	VOLTAGE	FREQUENCY	MOTOR POWER	CURRENT	MOTOR SPEED	WEIGHT
	mm	mm	mm	mm	mm	mm	m <sup>3</sup> /h	V	Hz	kW	A	rpm	kg
M-HA 250	1050	720	720	150	670x350	350x200	3000	380	50	0,37	1,2	1360	115
M-HA 280	1050	720	720	150	670x350	350x200	5000	380	50	0,55	1,6	1370	128
M-HA 315	1300	1030	720	150	980x350	600x245	7500	380	50	1,1	2,6	1390	180
M-HA 355	1400	1030	1030	150	980x660	800x250	10000	380	50	2,2	5,2	1420	235
M-HA 400	1400	1030	1030	150	980x660	800x300	15000	380	50	4	8,2	1430	260
M-HA 450 A	1710	1340	1340	150	1290x660	900x400	17500	380	50	5,5	11,2	1440	385
M-HA 450 B	1710	1340	1340	150	1290x660	900x400	20000	380	50	7,5	15,4	1450	400

## Performance Curves

### M-HA 250

Voltage 380 V  
Frequency 50 Hz  
Motor Power 0,37 kW  
Motor Speed 1360 rpm  
Weight 115 kg

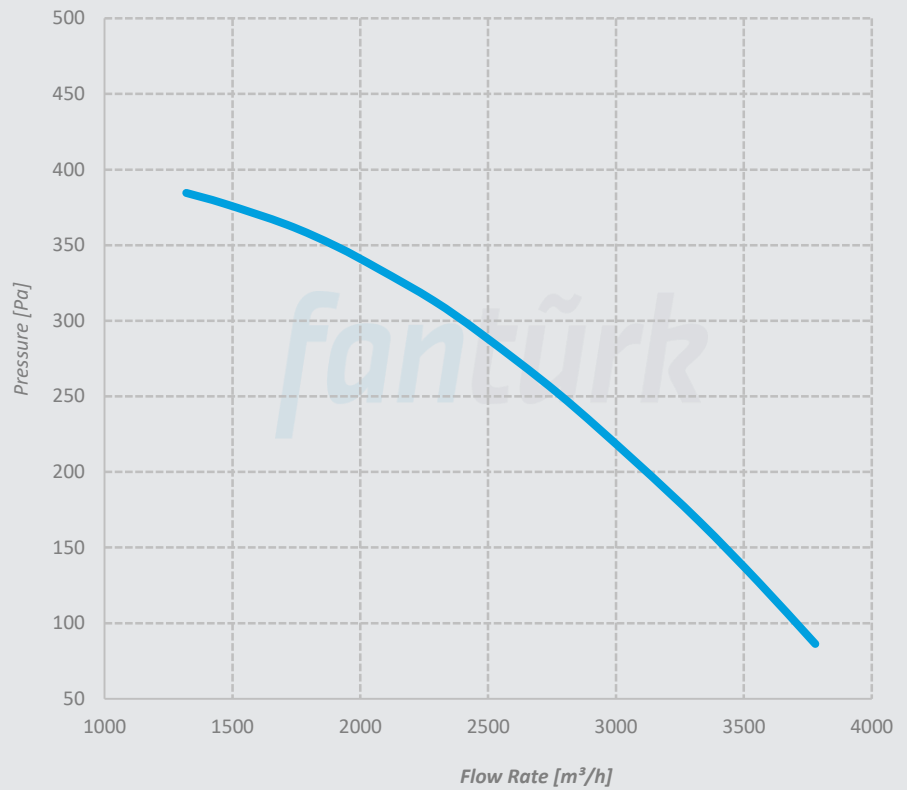

### M-HA 280

Voltage 380 V  
Frequency 50 Hz  
Motor Power 0,55 kW  
Motor Speed 1370 rpm  
Weight 128 kg

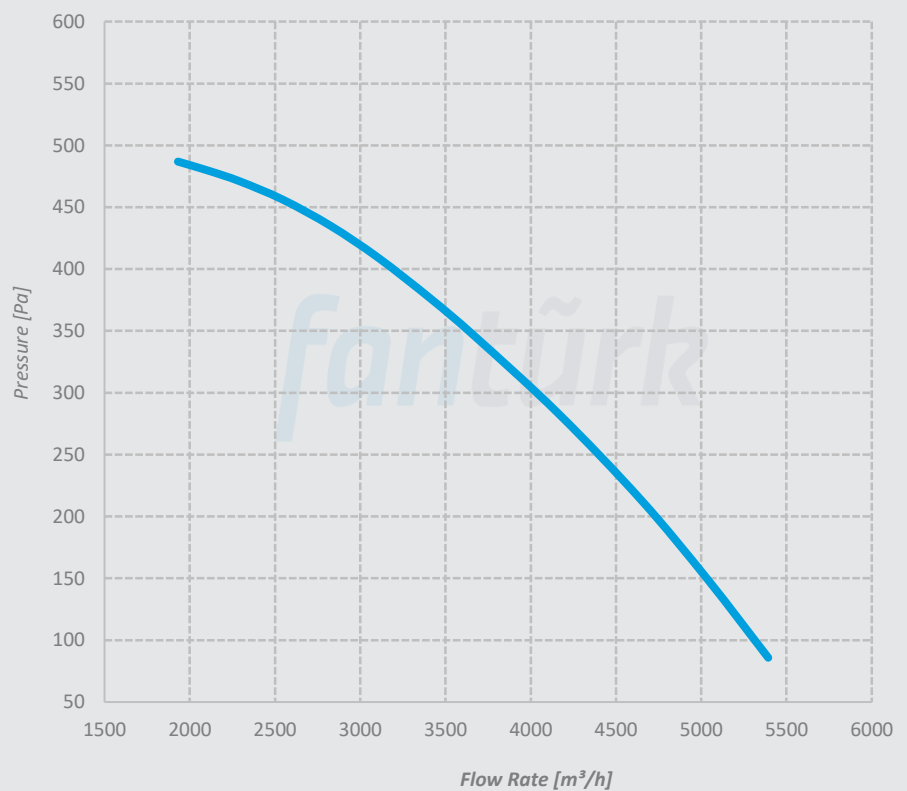

## Performance Curves

### M-HA 315

Voltage 380 V  
Frequency 50 Hz  
Motor Power 1,1 kW  
Motor Speed 1390 rpm  
Weight 180 kg

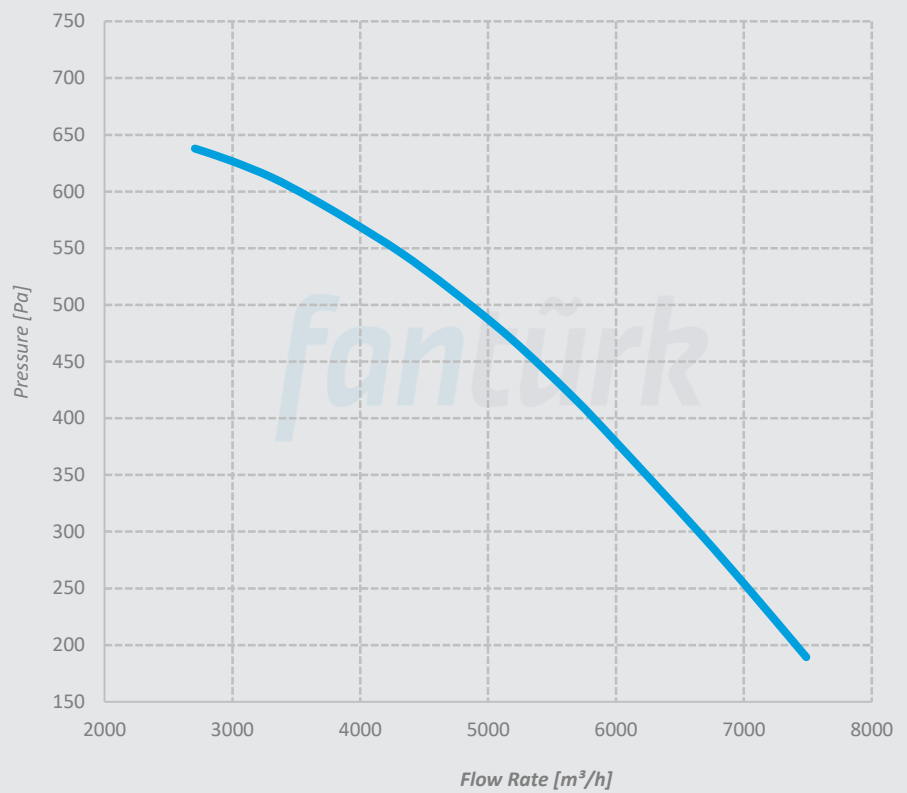

### M-HA 355

Voltage 380 V  
Frequency 50 Hz  
Motor Power 2,2 kW  
Motor Speed 1420 rpm  
Weight 235 kg

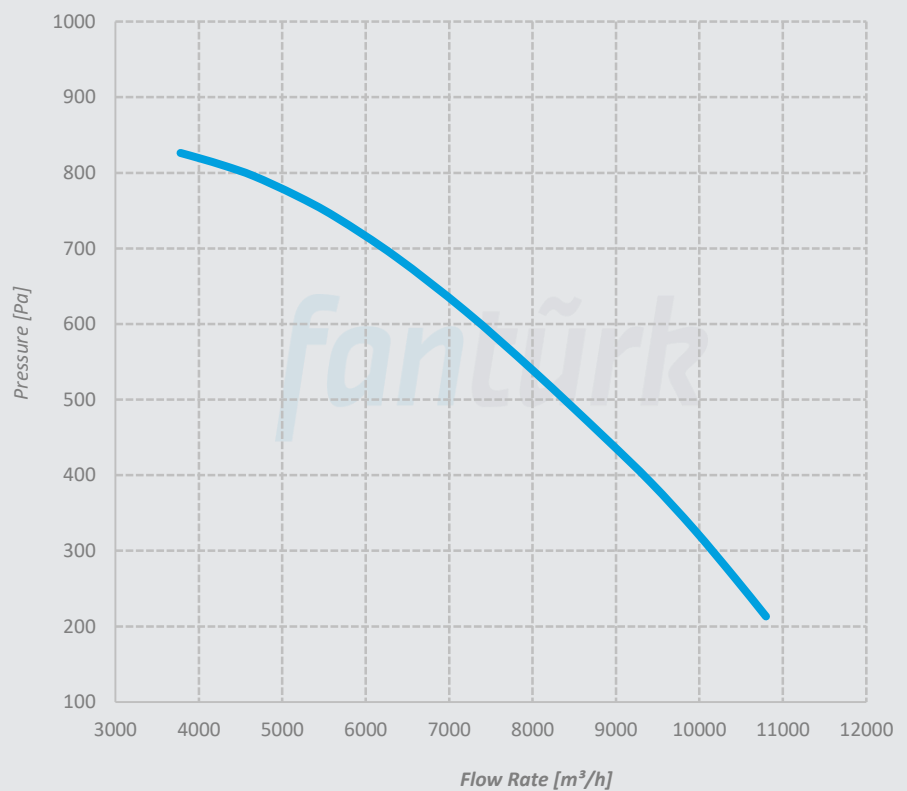

## Performance Curves

### M-HA 400

Voltage 380 V  
Frequency 50 Hz  
Motor Power 4 kW  
Motor Speed 1430 rpm  
Weight 260 kg

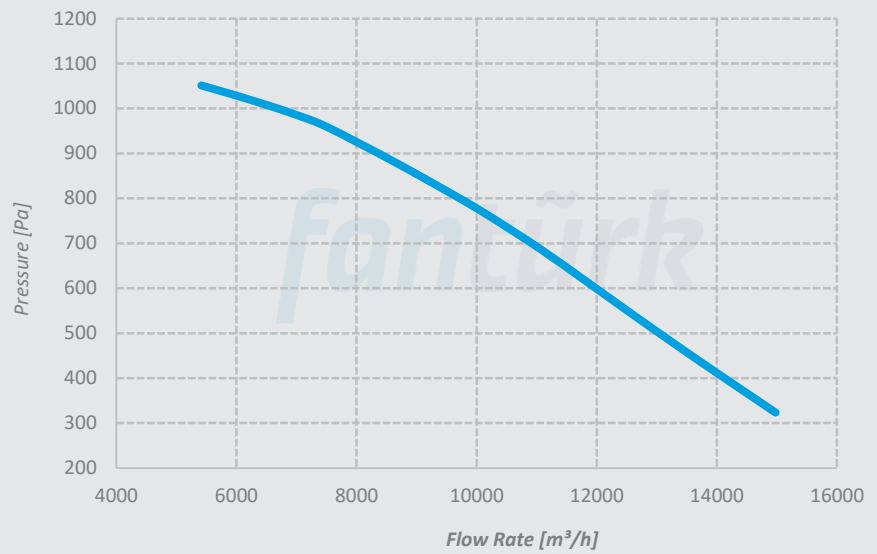

### M-HA 450 A

Voltage 380 V  
Frequency 50 Hz  
Motor Power 5,5 kW  
Motor Speed 1440 rpm  
Weight 385 kg

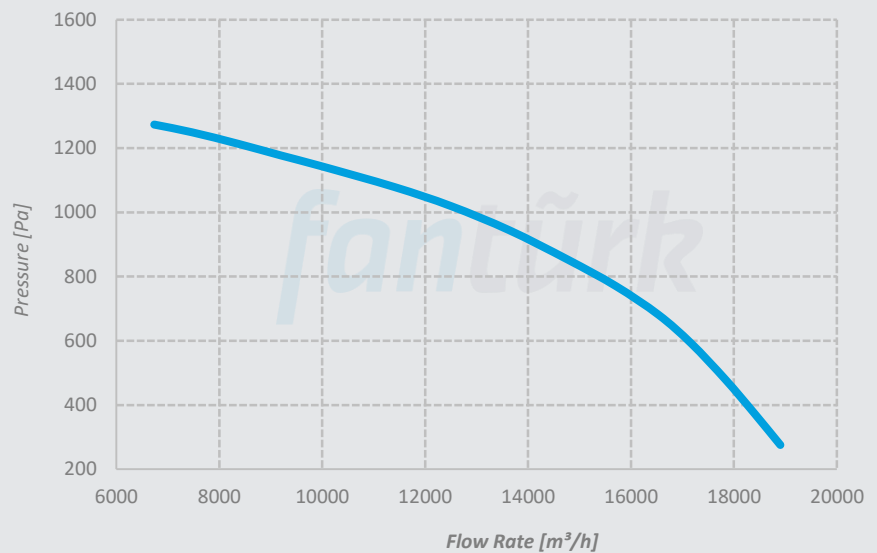

### M-HA 450 B

Voltage 380 V  
Frequency 50 Hz  
Motor Power 7,5 kW  
Motor Speed 1450 rpm  
Weight 450 kg

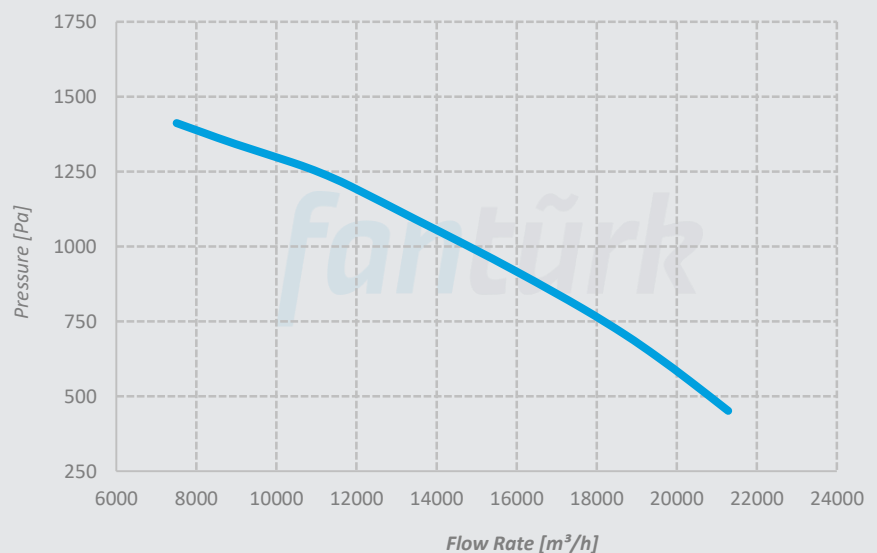





# *FKS Air Handling Unit*



## General Features



### Functionality and Quality Hidden in Every Detail...

- *Fantürk FKS Series Air Handling Units are manufactured in 28 different sections. Flow Rate range is 900 m<sup>3</sup> / h - 145 .000 m<sup>3</sup> / h for cooling and ventilation units and 900-194.000 m<sup>3</sup> / h for heating units only.*
- *Air Handling Units manufacturing with modular type and have double-skin panels.*
- *According to demand and application, rockwool, glasswool or polyurethane insulation, 50 mm or 60 mm thickness can be used for panels.*
- *Exterior skins are coated in RAL 9002 color as standard and for inner skins galvanized, painted or stainless steel can be used according to the request and application.*
- *Thanks to its flat inner surface, it is easy to clean and prevents dust accumulation.*
- *The case of the air handling units forms a strong structure with specially designed electrostatic coated aluminum profiles and plastic corner fittings. EPDM based gaskets are used for sealing.*
- *Filter selections are made taking into consideration the environment and process requirements of the device.*
- *High efficiency is achieved in coils and filters by preventing leakages that may occur during air flow with special designs.*
- *Depends on request plate type, rotor type or heat-pipe type heat recovery units can be used for energy efficiency which is of great importance nowadays.*
- *The fan-motor group is selected in the most efficient way considering the air flow and total static pressure. Fans can be selected with forward curved blades, backward curved blades and can be driven with belt-pulley or plug types according to the intended use and desired design criteria. Fans are approved with performance tests. The motors are IP55 class as standard and comply with CE norms.*
- *Dampers used in air handling units are manufactured using aluminum profile, aluminum wing and plastic based gears. The gears are outside of the air flow.*

## Air Handling Unit Selection Software

Selection and sizing of air handling units and taking a report which has all performance specifications can be easily made with «FKS Selection Software».

With this software all features below can be achieved;

- According to the desired air flow, air velocities in different device sections and serpentine surface can be examined and the most appropriate section can be determined. The desired device can be formed by bringing the specified elements side by side.
- Accessories for each element can be specified.
- In the selection of each element, you can see the brand and model alternatives together with the price rates, efficiency etc. The most suitable one can be selected.
- The maximum size can be determined by how many parts the device will be made up of.
- Dimensions and weights of the parts that make up the device can be seen.
- The technical report containing the price of the selected device, a scaled picture and the necessary information can be printed.

## Section and Flow Rates of FKS Series Air Handling Units

Models		Inner Cross-Section		Coil Surface Area	Flow Rate (m <sup>3</sup> /h)								
		Width (mm)	Height (mm)		m <sup>2</sup>	Air Velocity at Coil Surface							
				2 m/s		2,25 m/s	2,5 m/s	2,75 m/s	3 m/s	3,25 m/s	3,5 m/s	3,75 m/s	4 m/s
1	FKS 620-465	620	465	0,152	1093	1230	1366	1503	1639	1776	1913	2049	2186
2	FKS 620-620	620	620	0,22	1584	1782	1980	2178	2376	2574	2772	2970	3168
3	FKS 930-620	930	620	0,375	2700	3038	3375	3713	4050	4388	4725	5063	5400
4	FKS 1240-620	1240	620	0,53	3816	4293	4770	5247	5724	6201	6678	7155	7632
5	FKS 930-930	930	930	0,608	4374	4921	5468	6014	6561	7108	7655	8201	8748
6	FKS 1240-930	1240	930	0,859	6182	6955	7727	8500	9273	10046	10818	11591	12364
7	FKS 1550-930	1550	930	1,11	7990	8989	9987	10986	11985	12983	13982	14981	15980
8	FKS 1240-1240	1240	1240	1,187	8548	9616	10685	11753	12822	13890	14959	16027	17096
9	FKS 1550-1240	1550	1240	1,534	11048	12429	13810	15191	16572	17952	19333	20714	22095
10	FKS 1860-1240	1860	1240	1,882	13548	15241	16934	18628	20321	22015	23708	25402	27095
11	FKS 1550-1550	1550	1550	1,959	14106	15869	17632	19395	21158	22921	24685	26448	28211
12	FKS 1860-1550	1860	1550	2,402	17297	19459	21622	23784	25946	28108	30270	32432	34595
13	FKS 2170-1550	2170	1550	2,846	20489	23050	25611	28172	30734	33295	35856	38417	40978
14	FKS 1860-1860	1860	1860	2,923	21047	23678	26309	28940	31571	34201	36832	39463	42094
15	FKS 2170-1860	2170	1860	3,463	24931	28047	31163	34280	37396	40512	43629	46745	49861
16	FKS 2480-1860	2480	1860	4,002	28814	32416	36018	39620	43222	46823	50425	54027	57629
17	FKS 2170-2170	2170	2170	4,08	29372	33044	36716	40387	44059	47730	51402	55073	58745
18	FKS 2480-2170	2480	2170	4,715	33948	38192	42435	46679	50922	55166	59409	63653	67896
19	FKS 2790-2170	2790	2170	5,351	38524	43339	48155	52970	57785	62601	67416	72232	77047
20	FKS 2480-2480	2480	2480	5,428	39082	43967	48852	53737	58622	63508	68393	73278	78163
21	FKS 3100-2170	3100	2170	5,986	43099	48487	53874	59261	64649	70036	75424	80811	86198
22	FKS 2790-2480	2790	2480	6,16	44349	49893	55436	60980	66524	72067	77611	83155	88698
23	FKS 3100-2480	3100	2480	6,891	49617	55819	62021	68223	74425	80627	86829	93031	99233
24	FKS 3410-2480	3410	2480	7,623	54884	61745	68605	75466	82326	89187	96047	102908	109768
25	FKS 4030-2480	4030	2480	9,086	65419	73597	81774	89951	98129	106306	114484	122661	130838
26	FKS 4650-2480	4650	2480	10,549	75954	85449	94943	104437	113931	123426	132920	142414	151908
27	FKS 5270-2480	5270	2480	12,012	86489	97300	108112	118923	129734	140545	151356	162167	172979
28	FKS 5890-2480	5890	2480	13,476	97024	109152	121280	133408	145536	157665	169793	181921	194049

- For air handling units with heater or cooling coil, the air speed selection should be in the range of 2 m/s to 3 m/s.

# Practical Air Handling Unit Selection Table

Models	Flow Rate (x1000 m <sup>3</sup> /h)																					
	1	2	3	4	5	6	7	8	9	10	20	30	40	50	60	80	100	120	140	160	180	
1	FKS620-465																					
2	FKS620-620																					
3	FKS930-620																					
4	FKS1240-620																					
5	FKS930-930																					
6	FKS1240-930																					
7	FKS1550-930																					
8	FKS1240-1240																					
9	FKS1550-1240																					
10	FKS1860-1240																					
11	FKS1550-1550																					
12	FKS1860-1550																					
13	FKS2170-1550																					
14	FKS1860-1860																					
15	FKS2170-1860																					
16	FKS2480-1860																					
17	FKS2170-2170																					
18	FKS2480-2170																					
19	FKS2790-2170																					
20	FKS2480-2480																					
21	FKS3100-2170																					
22	FKS2790-2480																					
23	FKS3100-2480																					
24	FKS3410-2480																					
25	FKS4030-2480																					
26	FKS4650-2480																					
27	FKS5270-2480																					
28	FKS5890-2480																					

Air Velocity at Coil Surface

2-3 m/s  
3-4 m/s

# Dimensions of Air Handling Unit Parts

Models	Width	Height	Aspirator & Ventilator			Inlet & Outlet		Coarse Filter	Bag Filter	Carbon Filter	Mixing Coil	Electrical Heater	Heater Water Coil	Heater Steam Coil	Cooler Coil + Drift Eliminator	Steam Humidifier	Evaporative Humidifier	Water Humidifier	Diffuser	Sound Attenuator	Heat Recovery			Vacant Cell		
			Fan Direction			Rotor Type	Plate Type														Heat-Pipe Type					
			mm	mm	mm																	mm	mm		mm	mm
1	FKS 620-465	740	585	930	930	200	500	400	700	930	500	300	300	600	600	900	700	350	700-1200	600	930	18	19	20	600	600
2	FKS 620-620	740	740	930	930	200	500	400	700	930	500	300	300	600	600	900	700	350	700-1200	600	930	18	19	20	600	600
3	FKS 930-620	1050	740	930	930	200	600	400	700	930	500	300	300	600	700	900	800	350	700-1200	600	930	18	19	20	600	600
4	FKS 1240-620	1360	740	1240	1240	200	600	400	700	1550	500	300	300	600	700	900	800	350	700-1200	600	1240	18	19	20	600	600
5	FKS 930-930	1050	1050	1550	1550	300	800	400	700	1550	500	300	300	600	700	900	800	350	700-1200	600	1240	18	19	20	600	600
6	FKS 1240-930	1360	1050	1550	1550	400	800	400	700	1550	500	300	300	600	800	900	900	350	700-1200	600	1240	18	19	20	600	600
7	FKS 1550-930	1670	1050	1550	1550	400	800	400	700	1550	500	300	300	600	800	900	900	350	700-1200	600	1550	18	19	20	600	600
8	FKS 1240-1240	1360	1360	1860	1860	400	800	400	700	1550	700	300	300	600	800	900	900	350	700-1200	600	1550	18	19	20	600	600
9	FKS 1550-1240	1670	1360	1860	1860	500	1000	400	700	2170	700	300	300	600	900	900	1000	350	700-1200	600	1860	18	19	20	600	600
10	FKS 1860-1240	1980	1360	1860	1860	500	1000	400	700	2170	700	300	300	600	900	900	1000	350	700-1200	600	2480	18	19	20	600	600
11	FKS 1550-1550	1670	1670	1860	1860	500	1000	400	700	2170	700	300	300	600	900	900	1000	350	700-1200	600	2480	18	19	20	600	600
12	FKS 1860-1550	1980	1670	1860	1860	500	1000	400	700	2170	700	300	300	600	900	900	1000	350	700-1200	600	2480	18	19	20	600	600
13	FKS 2170-1550	2290	1670	1860	1860	500	1000	400	700	2170	700	300	300	600	1000	900	1200	350	700-1200	600	2480	18	19	20	600	600
14	FKS 1860-1860	1980	1980	2480	2480	500	1200	400	700	2170	-	300	300	600	1000	900	1200	350	700-1200	600	3100	18	19	20	600	600
15	FKS 2170-1860	2290	1980	2480	2480	500	1200	400	700	2170	-	300	300	600	1000	900	1200	350	700-1200	600	3100	18	19	20	600	600
16	FKS 2480-1860	2600	1980	2480	2480	600	1500	400	700	2170	-	300	300	600	1000	900	1200	350	700-1200	600	3100	18	19	20	600	600
17	FKS 2170-2170	2290	2290	2480	2480	600	1500	400	700	2170	-	300	300	600	1000	900	1200	350	700-1200	600	3100	18	19	20	600	600
18	FKS 2480-2170	2600	2290	2790	2790	700	1500	400	700	2790	-	300	300	600	1000	900	1200	350	700-1200	600	3100	18	19	20	600	600
19	FKS 2790-2170	2910	2290	2790	2790	700	1500	400	700	2790	-	300	300	600	1000	900	1200	350	700-1200	600	3100	18	19	20	600	600
20	FKS 2480-2480	2600	2600	2790	2790	900	1500	400	700	2790	-	300	300	600	1000	900	1200	350	700-1200	600	3500	18	19	20	600	600
21	FKS 3100-2170	3220	2290	2790	2790	700	1500	400	700	2790	-	300	300	600	1000	900	1200	350	700-1200	600	3500	18	19	20	600	600
22	FKS 2790-2480	2910	2600	2790	2790	900	1500	400	700	2790	-	300	300	600	1000	900	1200	350	700-1200	600	3500	18	19	20	600	600
23	FKS 3100-2480	3220	2600	2790	2790	900	1500	400	700	2790	-	300	300	600	1000	900	1200	350	700-1200	600	3500	18	19	20	600	600
24	FKS 3410-2480	3530	2600	2790	2790	900	1500	400	700	2790	-	300	300	600	1000	900	1200	350	700-1200	600	3500	18	19	20	600	600
25	FKS 4030-2480	4150	2600	2790	2790	900	1500	400	700	2790	-	300	300	600	1000	900	1200	350	700-1200	600	3500	18	19	20	600	600
26	FKS 4650-2480	4770	2600	3100	3100	900	1500	400	700	2790	-	300	300	600	1000	900	1200	350	700-1200	600	3500	18	19	20	600	600
27	FKS 5270-2480	5390	2600	3100	3100	900	1500	400	700	2790	-	300	300	600	1000	900	1200	350	700-1200	600	3500	18	19	20	600	600
28	FKS 8890-2480	6010	2600	3100	3100	900	1500	400	700	2790	-	300	300	600	1000	900	1200	350	700-1200	600	3500	18	19	20	600	600

## Construction of the Air Handling Unit

*Specially produced aluminum profiles and panels are used in Air Handling Units.*

*Electrostatic coated aluminum profiles are resistant to corrosion. Profiles are combined with specially designed plastic corners to each other.*

*The panels are manufactured in standard sizes, with double skins and rock wool, glass wool or polyurethane are used as insulation material between them. The panel thickness is 50 mm or 60 mm. The outer skin of the panels is made of RAL 9002 color coated with protective polyfilm as standard and the inner skins are made of galvanized, stainless or coated steel. Skin thickness is in 0.8 - 1.2 mm range. The panels are detachable from the outside. Inner surface of air handling units is designed to be completely flat. The panels are mounted directly to the profile with drill-ended screws. EPDM based sealings are adhered between the panels and profiles.*

*Service doors with sealing are mounted in the necessary places of the air handling unit. According to request and application, service doors can be produced with sight glass.*

*Depending on the size of the device, the base of the Air Handling Unit can be in one piece or divided on the basis of cells. Air handling units are manufactured on a base 150 mm height. There are lifting holes in the base for easy transportation. For outdoor devices, the device is protected from external weather condition with a specially designed roof.*

### Convenience in Transportation...

*In order to provide ease of transportation, the air handling unit can be shipped from cell to cell or shipped disassembled and can be assembled on working area. It is capable of being connected to each other by special connection elements in cell connection. Special EPDM seals are used to seal the joint surfaces.*



### Accessories

*Optionally, inside lighting, sight glass, manometer, flexible connection, siphon, maintenance switch, damper motor, rain protection can be used in the air handling units.*

### Filters

The cross-sectional dimensioning of Fantürk Air Handling Units is carried out in accordance with international standards, taking into account the filtration surface area. Filters are cassette type and can be easily installed and removed. Air leaks are prevented by suitable designs. The filter cells have a service door for maintenance and replacement. Optionally manometer, lightning and sight glass can be used. Different types and efficiency filters are used in air handling units considering the importance of indoor air quality.

Filter types in general;

- Panel filter
- Metal filter
- Bag filter
- Activated carbon filter
- Compact filter
- Hepa filter.

Panel filters are used as pre-filters. The filter material is synthetic or metallic. Metal filters feature oil retention. The filter classes we use are; for synthetic material: G2, G3, G4, for metallic material: G2, G3.

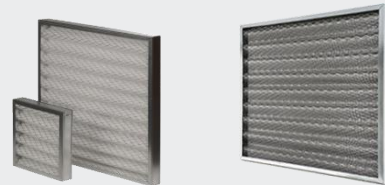

Bag filters are used for high efficiency air filtration. Their dust filtration capacity is high. They should be used together with a pre-filter to increase their service life. Bag length varies according to air flow as 305 mm, 508 mm, 635 mm. The filter classes we use are; G4, F5, F6, F7, F8.



Activated carbon filters are used to absorb foul-smelling gas or vapor molecules in the air (such as exhaust fumes, tire odor, alcohol, hydrocarbon, chlorine, and other chemical production processes). An alternative model is available for the absorption of odors emitted from other industrial processes such as hydrogen sulfide, sulfur dioxide, and should be used in combination with a pre-filter to increase their service life.

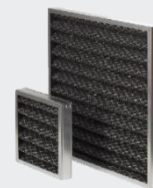

Compact filters are highly efficient filters. They should be used with a pre-filter. Because they are 292 mm deep, they occupy little space in the plant. Due to the filter structure, it is possible to distribute the air evenly over the entire filter surface. The filter classes we use are; F6, F7, F8, F9.



Hepa filters are used for hygienic environments. Their efficiency are very high. These filters are installed after the fan and must be used in combination with a pre-filter. The filter classes we use are; H10, H12, H13, H14.



### Heat Recovery System

Energy efficiency is great importance nowadays. Therefore, the use of heat recovery units in air handling units has started to be preferred. In Fantürk Air Handling Units, heat pipe, plate and rotor heat recovery elements can be used.

Efficiency in heat recovery systems in general;

- 30-50% in heat pipe type,
- 40-60% in plate type,
- 60-80% in rotary type.

#### Heat-Pipe Type Heat Recovery Unit

In the heat-pipe type heat recovery units which has a compact structure, heat transfer is occurs by the phase difference due to the temperature difference of the exhaust and fresh air in the closed circuit. No additional equipment is required. There is no mixing of fresh air and exhaust air. Easy to clean and maintain. They are preferred because of their long service life. Heat pipes can be manufactured as corrosion resistant.

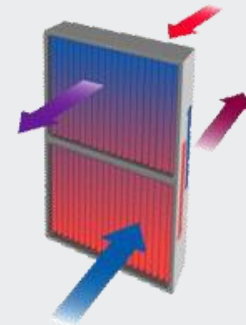

#### Plate Type Heat Recovery Unit

The cross-flow plate heat recovery elements allow the transfer of heat between fresh air and exhaust air without moving parts. Full sealing is ensured even at high pressure differences. It can operate between  $-30^{\circ}\text{C}$  and  $90^{\circ}\text{C}$ . The plates can be made of aluminum, epoxy coated aluminum or stainless steel. They are manufactured with by-pass dampers to prevent freezing for low temperatures. In the exhaust section, a condensate pan is installed to prevent condensation.

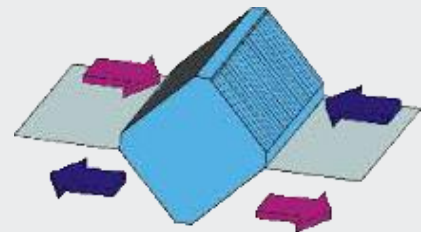

#### Rotor Type Heat Recovery Unit

They have a compact structure and high thermal performance. Heat transfer is carried out with aluminum plates in the appearance of corrugated sheet placed in the rotor. Rotor rotation is provided by belt-pulley driven electric motor. Due to its compact structure, it takes up little space. The heat efficiency of the rotors is optimized for a 12 rpm rotation speed. Can be increased according to application situation. If capacity control is required according to variable climatic conditions, speed control is performed with frequency converter. Request for capacity control is required in order. There is no risk of freezing.

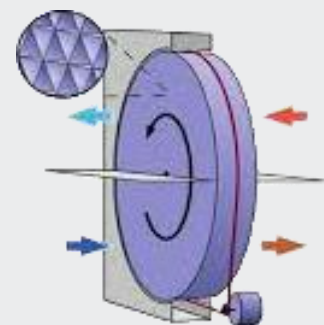



### Electrical Heater

Fantürk Air Handling Units can be equipped with electric heater upon request. It is used in the entrance of the device in areas with high risk of freezing. In addition, it is used at the exit of the plant in sensitive systems that require sudden heating. The electric heater cassette is made of galvanized or stainless material upon request. The elements are stainless material. Protection class is IP43. Gradual or proportional control can be made. It has CE certificate. As standard, heaters are equipped with automatic reset limit thermostat and manual reset safety thermostat. If the heater power is above 30 kW, it is recommended to operate the air handling unit's fan for 2-3 minutes after the electrical heater is de-energized. If there is an electric heater in the air handling unit, it is absolutely necessary to take precautions to turn the electric heater off in cases where the fan does not work or it operates at very low speeds (below 1.5 m / s).



### Heater or Cooler Coil

Heating and cooling operations are carried out with coils. The coil pipes may be copper or steel, blades may be aluminum, copper, steel, epoxy coated aluminum or epoxy coated copper. Direct expansion coils are manufactured as copper pipe-aluminum fins and collectors are made of copper. The serpentine cassette is made of galvanized steel. The test pressure is 20 bar. In hot and cold water coils, pipe inlet and outlet openings are threaded; In hot water and steam coils, pipe inlet and outlet openings are flanged. Designed to be easily removed for maintenance. Special by-pass sheets allow air to pass only through the coil surface. It is designed with reverse flow of air and water for high efficiency. In hot and cold water coils, the water inlet is from the bottom and the water outlet is from the top. In the cooling coils, the surface area of the coil is efficiently used thanks to the condensation pan installed in the panel. Condensate pan is made of stainless steel with double slope. After the cooling coil, a separator is used to separate the condensed water in the air.



### DX Coil

DX Coils minimize heat and energy loss by means of direct heat transfer from the air through refrigerant. At low temperatures in winter, it is necessary to use an electric or water preheater or a freezing thermostat. Outdoor unit connections can be made easily. Maintenance and repair is very simple.



## Equipments

### Rotor & Motor

Various fan types are available in each section in accordance with air flow and total pressure drop. Statically and dynamically balanced fans in accordance with international standards can be forward-curved, back-curved or airfoil blades depending on the intended use and customer requirements. Fan-motor group is selected considering high efficiency, low noise level and minimum energy consumption depending on air flow and total static pressure. In order to prevent vibration, the fan-motor group is connected to the device with spring insulators.

Standard bushed, fixed diameter pulleys are used as standard in our devices and it is possible to use variable diameter pulleys as an option. SPZ, SPA, SPB and SPC belt types are available. The belt is tensioned by a special mechanism.

The fan cell has a service door with safety guard for service and maintenance. In special cases, plug type fans are used and the motor is directly coupled.

The motors are IP55 protection class as standard and comply with CE norms. The motors are single speed as standard and double speed motors can be used as an option. A frequency converter for motor speed control is available as an accessory.

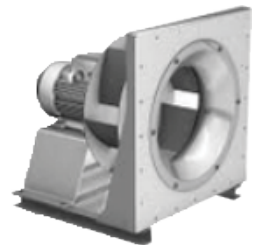

### Diffuser

Diffusers are used after the fan to ensure homogeneous distribution of air on the elements such as filters, coils, sound attenuator.





### Sound Attenuator

The noise level, which is of great importance in ventilation systems, is reduced to acceptable sound level by means of attenuators. The sound absorption coefficient of the attenuators varies according to the size of the attenuator used. The attenuator cell consists of backstands with rock wool in galvanized or stainless steel. The attenuator elements are designed so that they do not deform at an air velocity of 20 m/s. 6 different attenuator sizes are offered in Fantürk Air Handling Units. The following tables show the sound absorption capacities according to the size of the muffler.

Length of Attenuator (mm)	Sound Absorption Capacity (dB)							
	63 Hz	125 Hz	250 Hz	500 Hz	1000 Hz	2000 Hz	4000 Hz	8000 Hz
600	5	9	15	16	16	11	8	8
900	6	12	21	22	23	16	11	11
1200	7	15	27	28	29	20	12	12
1500	9	19	33	34	36	25	17	17
1800	10	22	39	40	42	29	20	20
2100	11	25	45	46	48	33	23	23

# Control Functions

Function - Equipment	Explanation	Standard-S Optional-O
Emergency Stop Button	Emergency stop button that stops the system in case of emergency	O
Terminal board for external cable connections	Motor terminal blocks are moved to an easily accessible panel outside the device	S
<p>AUTOMATIC CONTROL</p> <p>Electronic control panel            Duct type temperature sensor            Duct type humidity sensor            Valve actuators            Damper servomotors            Frequency converters</p>	<p>Air temperature control at desired points or contacts.            Humidity control at the desired point (s).            Control of two-way or three-way valves.            Control of dampers.            Air pressure control.</p>	<p>O            O            O            O            O</p>
<p>MICROPROCESSOR CONTROL</p> <p>Microprocessor            Duct type temperature sensors            Duct type humidity sensors            Differential pressure probes            Valve actuators            Damper servomotors            Frequency converters</p>  	<ul style="list-style-type: none"> <li>-Air flow is controlled. Pressure control can be made between two spaces. Generating alarm information if desired flow rate is not achieved (clogging, failure, contamination).</li> <li>-Adjustment of desired fan flow rate according to working altitude and temperature.</li> <li>-Pre-heating, heating, and cooling algorithms can optionally be made according to input, output or preheat temperatures.</li> <li>Ventilation temperature limit control can be done.</li> <li>-Detection of pollution of all filters used separately and generating alarm information.</li> <li>-DX Battery control provides efficient working conditions.</li> <li>-To see all the parameters, it is possible to change the terminal.</li> <li>-All devices can communicate in the form of a network.</li> <li>-Operation and configuration parameters can be encrypted.</li> <li>-Voice and visual alarm information can be given.</li> <li>-Daily, weekly work-stop time adjustment can be made.</li> <li>-Turkish, English languages can be used as desired.</li> <li>-All system can be connected to a central computer with additional hardware, managed and accessible via internet.</li> <li>-When the device configuration is changed, the new configuration can be defined parametrically. (addition of humidifier, valve-damper control changes, dehumidification, changing the fan control pattern, etc.)</li> <li>-The temperature control can be done as parametric proportional, proportional + integral or proportional + integral+ derivative.</li> <li>-Compensations can be made according to the outside air temperature and can be adjusted parametrically.</li> <li>-The control of the fans can be done parametrically, thermostatic, continuous, gradual or proportional.</li> <li>-The starting mode of fan motors (pole, star, triangle) can be set parametric.</li> <li>-Each equipment can be tested individually.</li> <li>-All kinds of alarm information is kept in memory (Differential pressure switches, thermal, sensor, emergency stop etc.)</li> <li>-All additional communication languages (Modbus, BACnet, Lon-ECHOLON, LAN TCP / IP, SNMP) can be integrated with the building automation system.</li> </ul>	<p>O</p>



# HNS Pool Dehumidification Unit



## General Features



If the partial pressure of the water vapor in the ambient air is lower than the saturation pressure, evaporation occurs on the surface of the pool water. In indoor swimming pools, large amounts of water evaporate continuously. As a result, the amount of moisture in the air rises to an undesirable level. Due to the high humidity in the air, perspiration occurs on windows and walls, causing corrosion and fungus formation on building components. In addition to the destruction of building components, it also causes discomfort such as decreased blood circulation and decreased sports capacity in humans. Humidity in indoor swimming pools should be between 40% and 64% according to VDI 2089/1.

As a result, it is possible to eliminate these negative effects by dehumidification, that is to keep the humidity values under comfort conditions.

- Fantürk HNS series Pool Dehumidification Units are modular type and have double skin panels.
- The panels used are 50mm thick and are produced by using stone wool insulation material.
- Outer surfaces are coated in RAL 9002 color as standard and galvanized sheet is used in inner surfaces.
- The case of the device forms a strong structure with specially designed electrostatic coated aluminum profiles and plastic corner fittings. EPDM based gaskets are used for sealing.
- Nowadays, heat-pipe type heat recovery units are used for energy efficiency which is very important.
- The fan-motor group is selected in the most efficient way considering the air flow and total static pressure. Fans can be selected with forward curved blades, backward curved blades and can be driven with belt-pulley or plug types according to the intended use and desired design criteria. Fans are approved with performance tests. The motors are IP55 class as standard and comply with CE norms.
- Dampers used in dehumidifications units are manufactured using aluminum profile, aluminum wing and plastic based gears. The gears are outside of the air flow.

## Scenarios

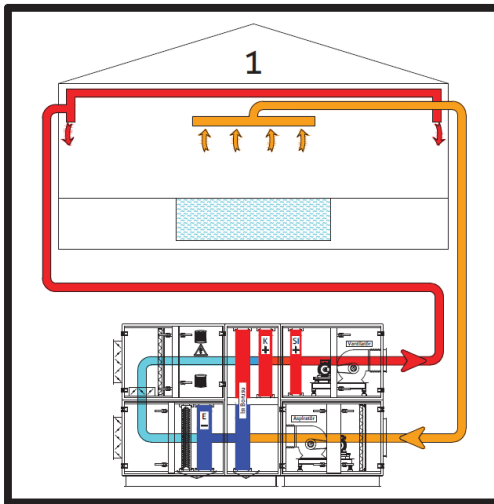

### Scenario 1: Winter – Night

It is generally preferred during winter time during night hours. Fresh air and exhaust dampers are closed as there are no users in the pool. The mixing damper is fully opened. It works with 100% indoor air. The compressor operates and the refrigerant performs its dehumidification task. The temperature of the air cooled to get moisture is increased by keeping the humidity rate constant while passing over the condenser.

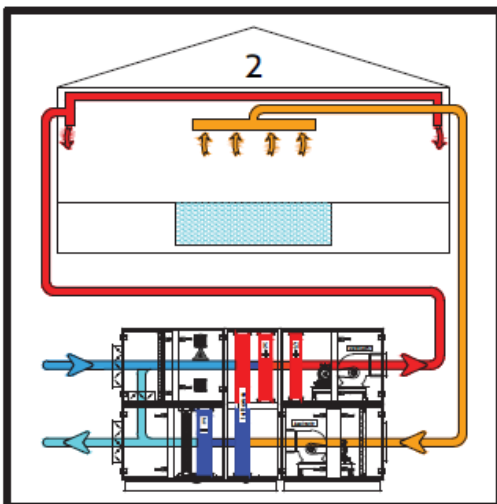

### Scenario 2: Winter – Day

It is generally preferred for daytime hours when the pool is actively used in winter when the outside temperature is low. As the suction air passes through the heat pipe, it leaves some of the heat on it. The compressor operates and the refrigerant performs the dehumidification task. For energy economy, some exhaust air is mixed with fresh air. The heat accumulated in the heat pipe is recovered. The heater coil brings the reduced blowing temperature after dehumidification to the comfort level.

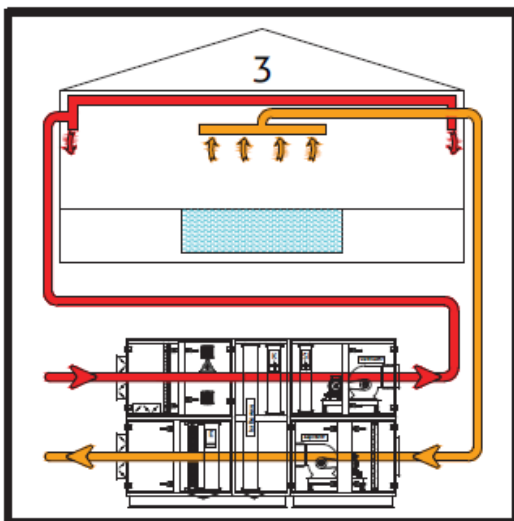

### Scenario 3 : Summer

It is generally preferred for situations where the outdoor temperature is higher than the indoor temperature. In such applications, the heat pipe and compressor are deactivated. The humidity is kept constant with 100% fresh air.

## Technical Specifications

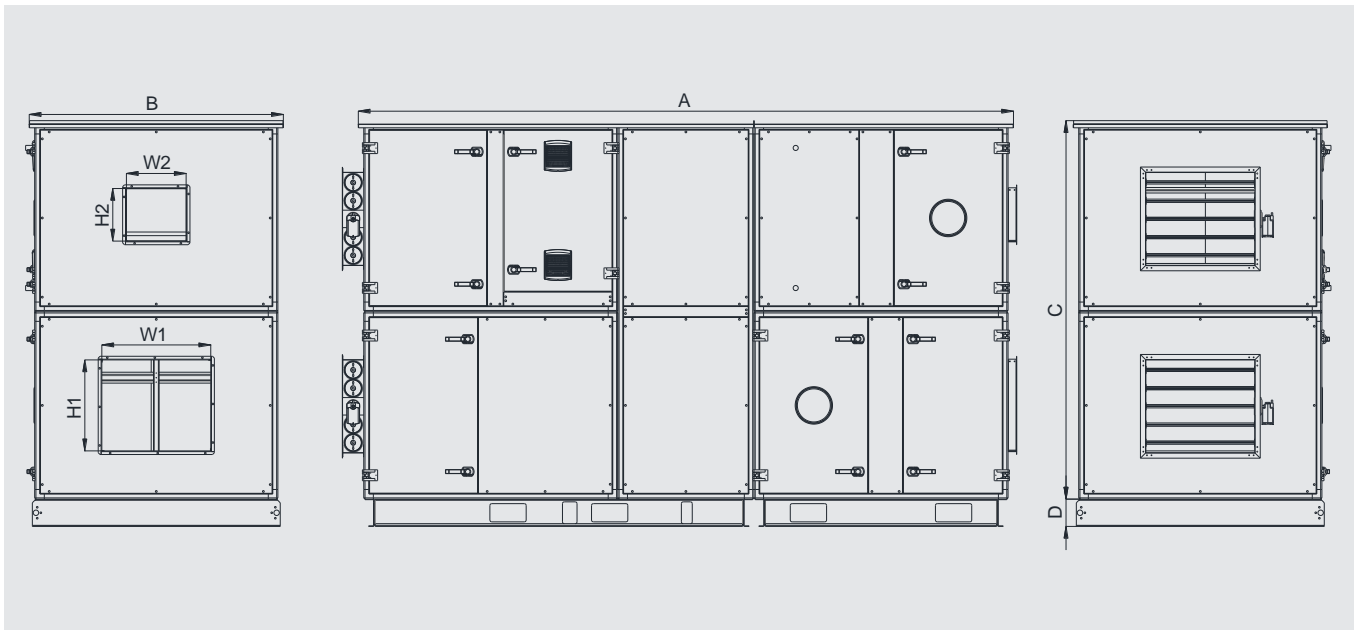

MODEL		HNS-3000	HNS-4500	HNS-6000	HNS-7500	HNS-9000	HNS-12000	HNS-15000	HNS-18000	HNS-21000	HNS-24000
*Dehumidification Capacity	[kg/h]	20	30	40	50	60	80	100	120	140	160
Flow Rate	[m <sup>3</sup> /h]	3000	4500	6000	7500	9000	12000	15000	18000	21000	24000
Ventilator Pressure	[Pa]	300	300	300	300	300	300	300	300	300	300
Aspirator Pressure	[Pa]	300	300	300	300	300	300	300	300	300	300
Ventilator Motor	[kW-rpm]	1,1-3000	1,5-3000	2,2-1500	3-1500	4-1500	5,5-1500	5,5-1000	7,5-1000	7,5-1000	7,5-1000
Aspirator Motor	[kW-rpm]	1,1-3000	1,5-3000	2,2-1500	3-1500	4-1500	5,5-1500	5,5-1000	7,5-1000	7,5-1000	7,5-1000
Cooling Capacity	[kW]	14,5	24,5	34	37,9	49	67,8	79,5	94,7	114,7	145,6
Heater Water Coil Capacity (90/70°C)	[kW]	26	36	50,5	63	77,1	102	127	152	176	210
Compressor Power	[kW]	4,75	5,22	7,05	7,76	10,25	14,1	17,8	20,46	23,5	30,7
**Total Motor Power	[kW]	7,45	9,75	12,75	15,3	20,5	27,7	30,65	38,05	40,5	48,7
A	[mm]	3490	2910	3000	3210	3210	4200	4355	3510	4665	4665
B	[mm]	1090	1040	1350	1660	1660	1980	1980	2280	2290	2290
C	[mm]	1450	2060	2060	2060	2060	2110	2730	2680	2730	2730
D	[mm]	150	150	150	150	150	150	150	150	150	150
Inlet from Pool-side	[mm]	600x300	600x400	600x500	900x600	900x600	900x600	1100x700	1100x700	1100x700	1100x700
Outlet to Pool-side	[mm]	600x300	600x400	600x500	900x600	900x600	900x600	1100x700	1100x700	1100x700	505x505

● \* Designed according to VDI 2089. (Room conditions are based on 30 °DB, 50% RH and + 5 °C evaporation.)

● \*\* Electric heater is not included.

## Construction of Pool Dehumidification Unit

*Specially produced aluminum profiles and panels are used in Dehumidification Units.*

*Electrostatic coated aluminum profiles are resistant to corrosion. Profiles are combined with specially designed plastic corners to each other.*

*The panels are manufactured in standard sizes, with double skins and rock wool, glass wool or polyurethane are used as insulation material between them. The panel thickness is 50 mm or 60 mm. The outer skin of the panels is made of RAL 9002 color coated with protective polyfilm as standard and the inner skins are made of galvanized, stainless or coated steel.*

*Skin thickness is in 0.8 - 1.2 mm range. The panels are detachable from the outside. Inner surface of dehumidification unit is designed to be completely flat. The panels are mounted directly to the profile with drill-ended screws. EPDM based sealings are adhered between the panels and profiles.*

*Service doors with sealing are mounted in the necessary places of the air handling unit. According to request and application, service doors can be produced with sight glass.*

*Depending on the size of the device, the base of the Dehumidification Unit can be in one piece or divided on the basis of cells. Air handling units are manufactured on a base of 100 mm for low pressures and 150 mm for high pressures. There are lifting holes in the base for easy transportation. For outdoor devices, the device is protected from external weather condition with a specially designed roof.*

### **Easy Installation and Transportation with Original Modular Design...**

*Fanturk branded HNS series Pool Dehumidification Units are manufactured to be modular with a unique design. The device consists of three different cells. This unique design facilitates transportation and assembly. Optionally, the device can be delivered in a single structure or cell by cell or disassembled and can be assembled on the construction site. It is capable of being connected to each other by special connection elements in cell connection. Special EPDM seals are used to seal the joint surfaces.*





## Equipments

### Rotor & Motor

Various fan types are available in each section in accordance with air flow and total pressure drop. Statically and dynamically balanced fans in accordance with international standards can be forward-curved, back-curved or airfoil blades depending on the intended use and customer requirements. Fan-motor group is selected considering high efficiency, low noise level and minimum energy consumption depending on air flow and total static pressure. In order to prevent vibration, the fan-motor group is connected to the device with spring insulators.

Standard bushed, fixed diameter pulleys are used as standard in our devices and it is possible to use variable diameter pulleys as an option. SPZ, SPA, SPB and SPC belt types are available. The belt is tensioned by a special mechanism.

The fan cell has a service door with safety guard for service and maintenance. In special cases, plug type fans are used and the motor is directly coupled.

The motors are IP55 protection class as standard and comply with CE norms. The motors are single speed as standard and double speed motors can be used as an option. A frequency converter for motor speed control is available as an accessory.

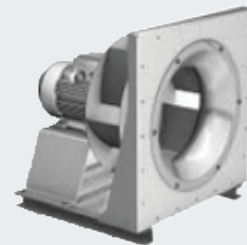

### Heater – Cooler Equipments

Heating and cooling operations are carried out with coils. The coil pipes can be copper or steel, blades can be aluminum, copper, steel, epoxy coated aluminum or epoxy coated copper. The collectors are made of copper. The coil cassette is made of galvanized steel sheets. The test pressure is 20 bar. Designed to be easily removed for maintenance. Special by-pass sheets allow air to pass only through the coil surface. Air and refrigerant are designed as reverse flow for high efficiency. In hot and cold water coils, the water inlet is from the bottom and the water outlet is from the top. In the cooling coils, the surface area of the serpentine is efficiently used thanks to the condensation pan installed in the panel. Condensate pan is made of stainless steel with double slope. After cooling coil, a drift eliminator made of PVC material is used to keep the condensed water in the air. A rubber rosette is installed on the pipe to prevent air leakage and possible condensation between the heater and cooling coil water inlet-outlet pipes and the panel sheet.



### Compressor

Scroll type compressors are used in HNS series Pool Dehumidification Units. All equipment used is protected against high temperatures and currents. R407C is used as refrigerant.



## Equipments

### Filters

G4 filter is used in inlet and outlet line in dehumidification units. The cross-sectional dimensioning is carried out in accordance with international standards, taking into account the filtration surface area. Filters are cassette type and can be easily installed and removed. Air leaks are prevented by suitable designs. The filter cells have a service door for maintenance and replacement. Optionally manometer, lightning and sight glass can be used.

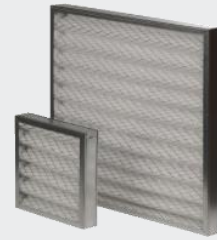

### Heat Recovery Unit

Energy efficiency is of great importance nowadays. For this reason, heat-pipe type heat recovery unit is preferred in HNS series Pool Dehumidification Units. In this way, while efficiency is increasing, energy consumption and operating costs are reduced to minimum levels.

In the heat-pipe type heat recovery units which has a compact structure, heat transfer is occurs by the phase difference due to the temperature difference of the exhaust and fresh air in the closed circuit. No additional equipment is required. There is no mixing of fresh air and exhaust air. Easy to clean and maintain. They are preferred because of their long service life. Heat pipes can be manufactured as corrosion resistant.. The surface area of the heat recovery unit is efficiently used thanks to the condensation pan installed in the panel. Condensate pan is made of stainless steel with double slope.

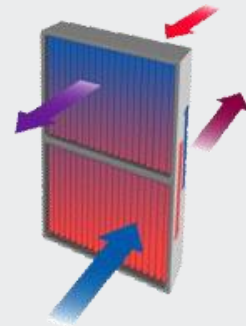

### Control Panel

Pool dehumidification units are the systems that take the moisture on it by cooling and reheating the air with the compressor structure. Pool dehumidification units are used for dehumidification in the pools of hotels, schools and private pools. The HV-DHMC-1-M controller is designed for the control of compressor dehumidification units. It is possible to control and monitor with building management systems.

The controller features

- Connection to building management systems (Modbus-RTU)
- Fault entries
- Enthalpy
- Weekly Schedule (Optional)
- Keylock



## Practical Capacity Calculation

The following formula can be used to practically calculate the amount of evaporation that will occur on the surface of the pool. Please refer to the tables below for the coefficients in the formula.

$$Wp = (Fa \times A \times k) / 1,5$$

- Wp: Evaporation Amount (kg/h)
- A: Pool Surface Area (m<sup>2</sup>)
- Fa: Activity Factor
- k: Evaporation Coefficient

Air Temperature (°C)	Relative Humidity (%)																	
	50	55	60	50	55	60	50	55	60	50	55	60	50	55	60	50	55	60
20	0,410	0,384	0,353	0,492	0,465	0,434	0,573	0,548	0,516	0,654	0,629	0,597	0,788	0,762	0,731	0,923	0,897	0,866
21	0,396	0,362	0,330	0,477	0,444	0,413	0,560	0,525	0,494	0,641	0,606	0,575	0,774	0,740	0,710	0,908	0,875	0,843
22	0,374	0,341	0,308	0,456	0,422	0,390	0,537	0,503	0,471	0,618	0,584	0,552	0,753	0,719	0,687	0,887	0,852	0,821
23	0,353	0,318	0,287	0,434	0,399	0,368	0,516	0,480	0,449	0,597	0,563	0,531	0,731	0,696	0,665	0,864	0,830	0,798
24	0,330	0,296	0,264	0,413	0,378	0,345	0,494	0,459	0,426	0,575	0,540	0,509	0,710	0,674	0,642	0,843	0,809	0,776
25	0,309	0,275	0,242	0,390	0,356	0,323	0,473	0,437	0,405	0,554	0,518	0,486	0,687	0,653	0,620	0,821	0,786	0,755
26	0,287	0,252	0,219	0,369	0,333	0,300	0,450	0,414	0,383	0,531	0,497	0,464	0,666	0,630	0,597	0,800	0,764	0,732
27	0,266	0,230	0,197	0,347	0,312	0,279	0,429	0,393	0,360	0,510	0,474	0,441	0,644	0,608	0,576	0,777	0,743	0,710
28	0,243	0,209	0,176	0,326	0,290	0,257	0,407	0,371	0,338	0,488	0,452	0,419	0,623	0,587	0,554	0,756	0,720	0,687
29	0,222	0,186	0,146	0,303	0,267	0,227	0,386	0,350	0,308	0,467	0,431	0,390	0,600	0,564	0,524	0,735	0,698	0,657
30	0,201	0,164	0,107	0,282	0,246	0,189	0,363	0,327	0,270	0,444	0,408	0,351	0,579	0,542	0,486	0,713	0,677	0,620
Water Temperature (°C)	24			26			28			30			32			34		

(k) Table of Evaporation Coefficient

Pool Type	Activity Factor (Fa)
Pools Out of Working Hours	0,50
Residential Pools	0,50
Floor Pools	0,65
Therapy Pools	0,65
Hotel Pools	0,80
Public Pools	1,00
Hot Springs Pools	1,00
Wavy Pools	1,50

(Fa) Table of Activity Factor

Pool Type	Air Temp. (°C)	Water Temp. (°C)	Relative Humidity (%)
Treatment Pools	29 – 32	29 – 32	50 – 60
Therapy Pools	27 – 29	29 – 35	50 – 60
Hotel Pools	28 – 29	28 – 30	50 – 60
Hot Springs Pools	27 – 29	36 – 40	50 – 60
Entertainment Pools	24 – 29	24 – 29	50 – 60
Competition Pools	26 – 29	24 – 28	50 – 60
Diving Pools	27 – 29	27 – 32	50 – 60

Table of Confor Conditions

### Sample of Capacity Calculation

The surface area of a hotel pool is 55 m<sup>2</sup> with an ambient temperature of 28 °C and a relative humidity of 50%, and a pool water temperature of 30 °C. What is the amount of evaporation from this pool?

According to the given values (k) k = 0.488 is determined from the Evaporation Coefficient Table.

Fa = 0.8 is determined from Usage Factor Table.

$$Wp = (0.8 \times 55 \times 0.488) / 1.5 = 14.31 \text{ kg / h}$$



# *FRTT* *Rooftop Air Handling* *Unit*



## General Features



Rooftops are packaged air conditioners that can cool or heat/cool the room air, cool the room air in summer with cooling/DX coil and heat the room air by means of a direct expansion refrigerant systems, Rooftops can meet the fresh air of the space and can perform all heating, cooling and ventilation process in a complete single unit.

Fantürk FRTT series is designed for use in areas that only need cooling (Tropical) and designed for areas that need heating and cooling. FRTT series is offered with many capacity options according to the size of the environment to be air conditioned.

Ana kullanım alanları geniş ticari binalar, iş merkezleri, havalimanları, restoranlar, büyük mağazalar, sinema ve tiyatro salonları, konferans salonları, endüstriyel binalar ve lojistik merkezleridir.

Usage areas are large commercial buildings, business centers, airports, restaurants, large stores, cinema-theater halls, industrial buildings, logistics centers.

## Working Limits

Cooling	Outside Temperature		Inside Temperature	
	Dry Bulb Temperature (°C)	Wet Bulb Temperature (°C)	Dry Bulb Temperature (°C)	Wet Bulb Temperature (°C)
Minimum	15	7	18	14
Nominal	35	24	27	19
Maximum	52	27	36	24

## Features

### FRTT-Tropical Type Fanturk Rooftop

- High efficiency and quiet running fans
- Compact design
- Automatic control systems
- Plug and run

### Compressor

- High efficiency
- Quiet running
- Fewer moving parts
- Compact design

### Coils

- Copper pipe, aluminum fin
- High temperature and humidity efficiency

### Filter

- Energy saving
- Large filtration area for long service time

### Case

- Electrostatic powder paint galvanized sheet metal
- 50 mm insulation
- Ease of maintenance and service

### Options

- Economizer
- Bag filter cell
- Electric heater
- Electronic expansion valve
- Filter pollution sensor
- CO2 sensor
- Enthalpy control
- Condenser fan speed control
- Smoke detector

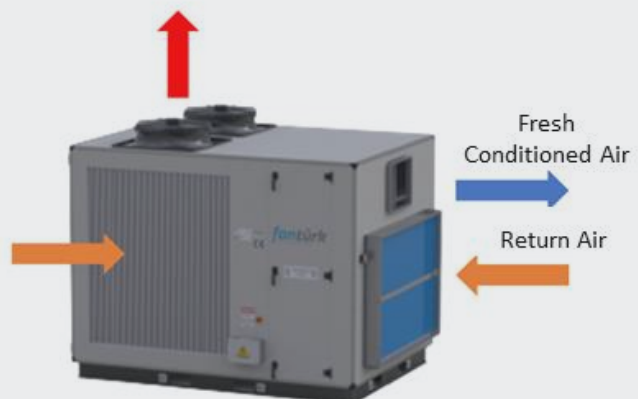
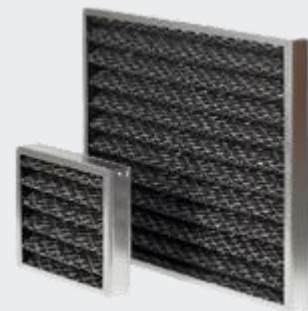

## Technical Specifications

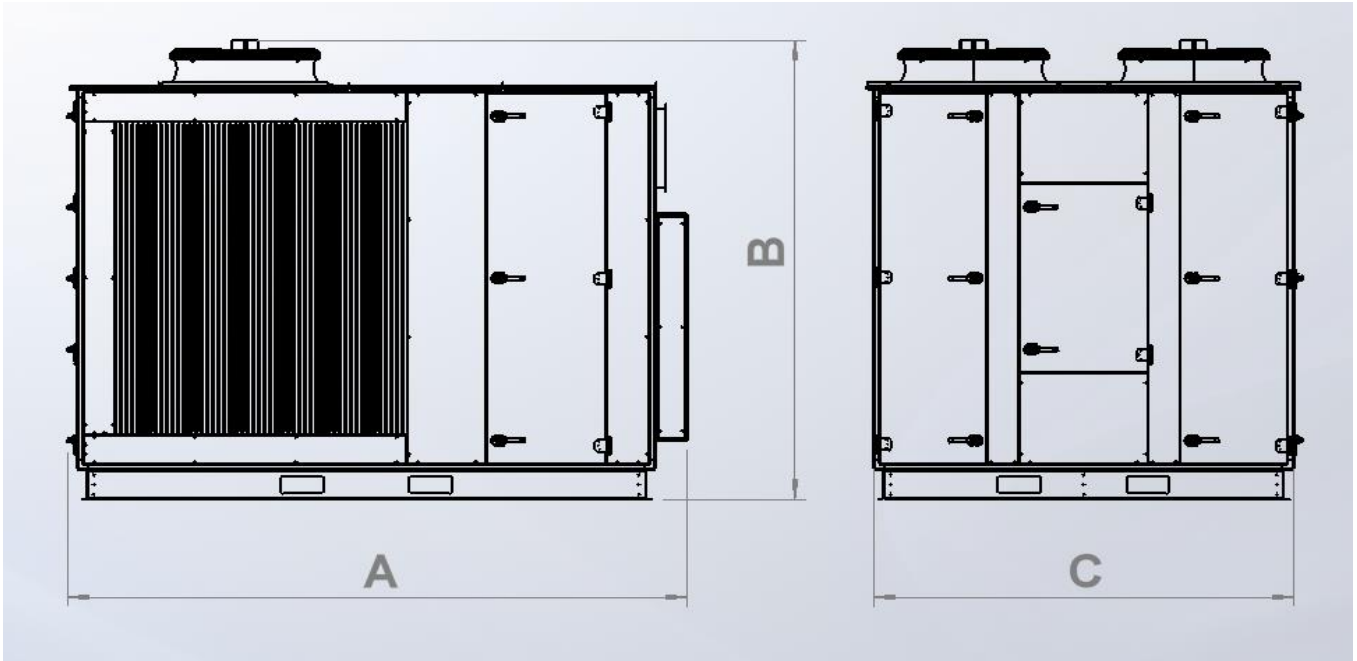

MODEL		FRTT-018	FRTT-023	FRTT-032	FRTT-037	FRTT-040	FRTT-046	FRTT-056
Air Flow Rate	[m <sup>3</sup> /h]	3600	5000	5850	6600	7800	10000	10500
External Pressure	[Pa]	300	300	300	300	300	300	300
Cooling Capacity [1]	[kW]	18	23	31	36	40	46	55
Total Power [1]	[kW]	6	9	11	12	14	18	20
Cooling Capacity [2]	[kW]	8	19	25	30	33	38	46
Total Power [2]	[kW]	8	10	13	14	17	21	24
Cooling Capacity [3]	[kW]	13	17	22	26	29	33	40
Total Power [3]	[kW]	9	11	14	16	19	23	26
Condenser Fan Type		Axial						
Condenser Fan Quantity		1	1	1	1	2	2	2
Compressor Type And Quantity	[kW]	Scroll-1	Scroll-1	Scroll-1	Scroll-1	Scroll-2	Scroll-2	Scroll-2
Weight	[kg]	400	415	472	550	610	670	740
Electrical Information		380-400V/3 ph./50 Hz						
A	[mm]	1600	1600	1400	1900	1900	2100	2250
B	[mm]	1100	1400	1400	1500	1600	1900	1900
C	[mm]	1400	1400	1600	1700	1750	1800	1850

- [1] Outdoor Temp. 35°C KT, Indoor Temp. 26,7°C KT/19,4°C YT
- [2] Outdoor Temp. 46°C KT, Indoor Temp. 26,7°C KT/19,4°C YT
- [3] Outdoor Temp. 52°C KT, Indoor Temp. 26,7°C KT/19,4°C YT

## Technical Specifications

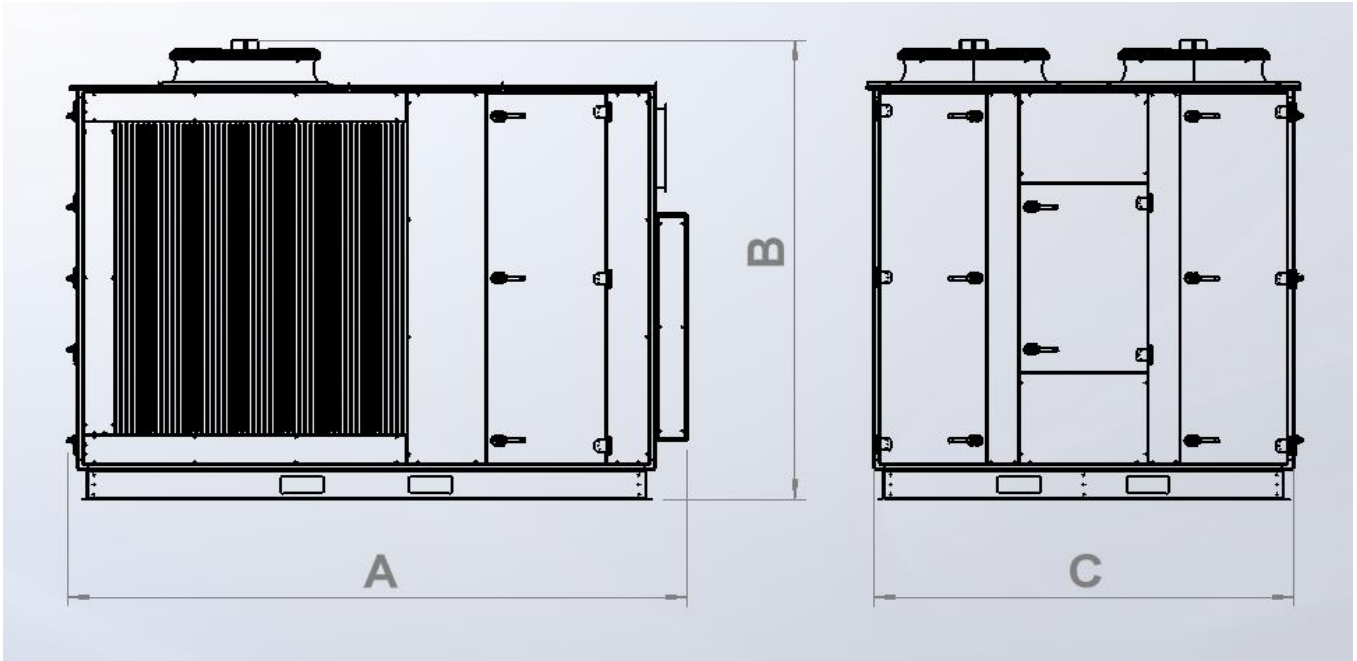

MODEL		FRTT-062	FRTT-072	FRTT-081	FRTT-092	FRTT-111	FRTT-124	FRTT-152
Air Flow Rate	[m <sup>3</sup> /h]	11500	13000	15000	16800	19000	21500	25000
External Pressure	[Pa]	300	300	300	300	300	300	300
Cooling Capacity [1]	[kW]	62	72	80	92	111	124	151
Total Power [1]	[kW]	26	26	27	32	40	44	56
Cooling Capacity [2]	[kW]	51	59	66	77	103	102	126
Total Power [2]	[kW]	30	30	33	37	53	53	66
Cooling Capacity [3]	[kW]	45	53	58	67	81	90	112
Total Power [3]	[kW]	33	37	37	41	58	58	72
Condenser Fan Type		Axial						
Condenser Fan Quantity		2	2	2	2	4	4	4
Compressor Type And Quantity	[kW]	Scroll-2	Scroll-2	Scroll-2	Scroll-2	Scroll-4	Scroll-4	Scroll-4
Weight	[kg]	820	940	970	1200	1350	1450	1750
Electrical Information		380-400V/3 ph./50 Hz						
A	[mm]	2300	2400	2600	2700	3500	3500	3500
B	[mm]	1900	1950	1950	2100	2200	2300	2300
C	[mm]	1900	2000	2100	2250	2350	2450	2550

- [1] Outdoor Temp. 35°C KT, Indoor Temp. 26,7°C KT/19,4°C YT
- [2] Outdoor Temp. 46°C KT, Indoor Temp. 26,7°C KT/19,4°C YT
- [3] Outdoor Temp. 52°C KT, Indoor Temp. 26,7°C KT/19,4°C YT





***F-EVAP***  
***Evaporative***  
***Cooling Device***

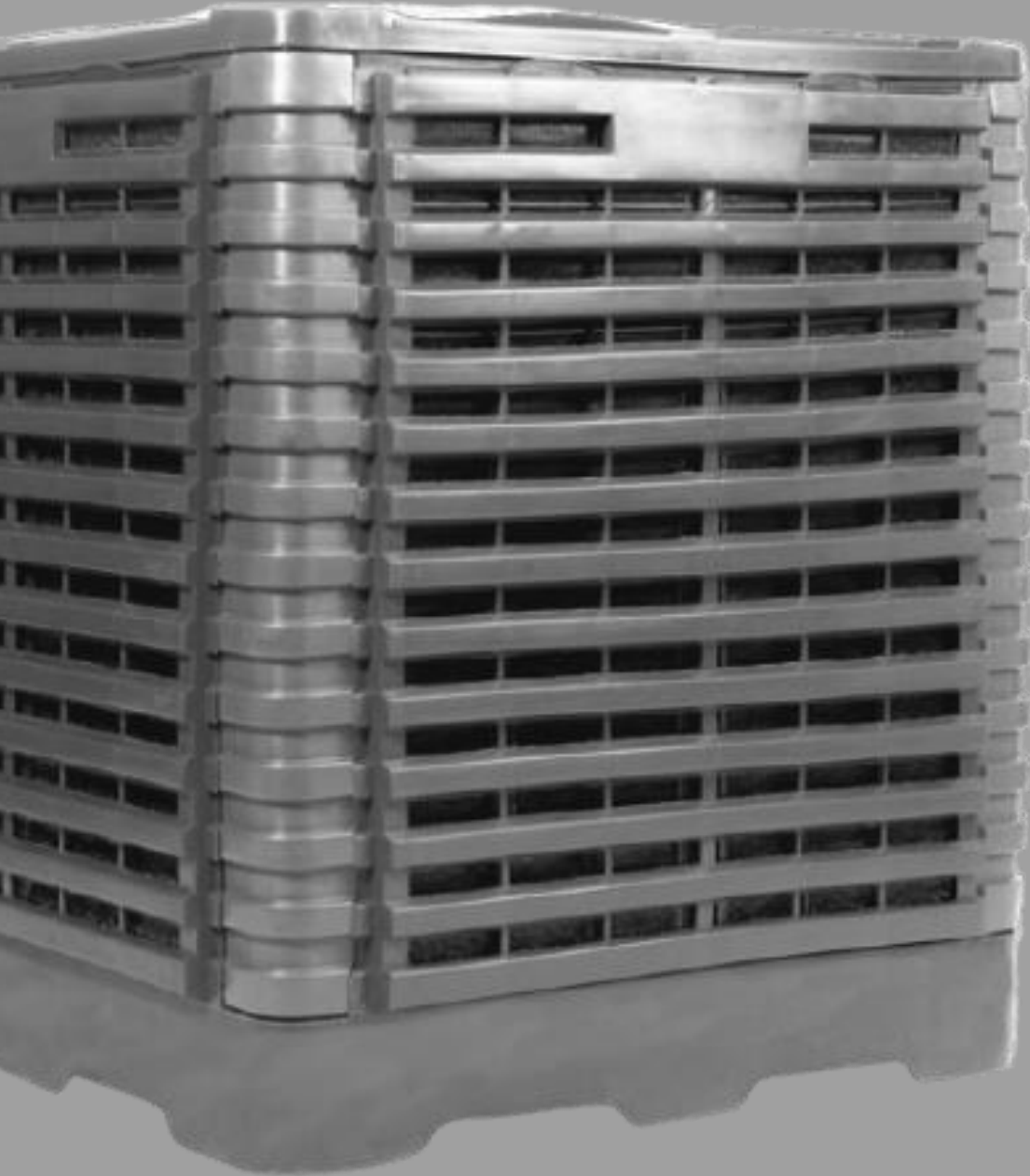

## Technical Specifications

# Evaporative Cooling Device

Evaporative air conditioning system provide fresh air and cool air to the environment and bu evucuating the existing bad air in the environment, fresh air and cool air are provided to the environment. The cold and fresh air produced by industrial type evaporative cooling units is transferred to the indoor environment through air ducts. Evaporative coolings units are designed for high efficiency, low pressure loss and reliable use for years.

### Usage Areas

Evaporative cooling units provide cooling and air conditioning in large closed areas (warehouses, production facilities, hangars) with lower energy consumption than conventional air conditioners. Evaporative cooling devices can be easily mounted on roofs and walls and only needs water to provide cooling.

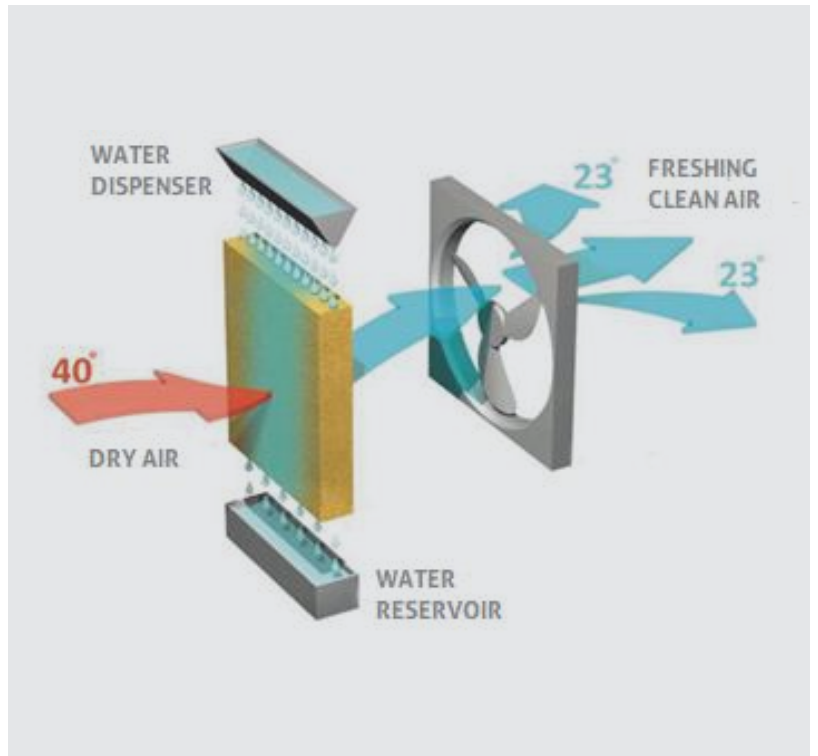
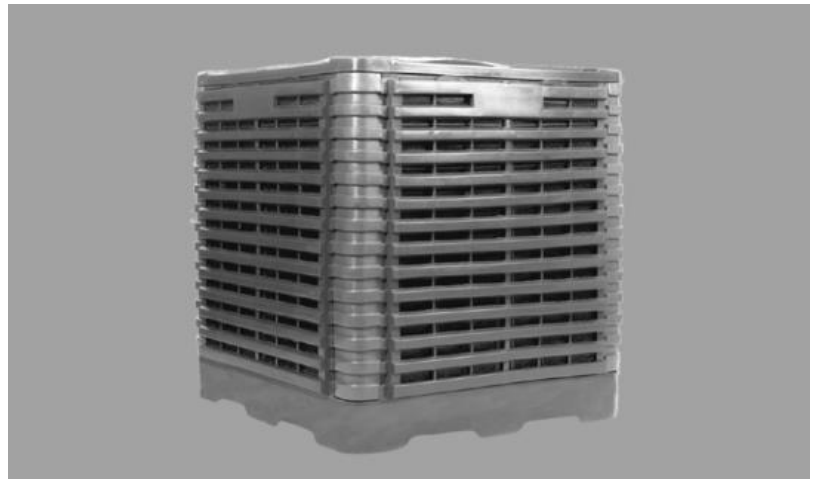

MODEL	AIR FLOW RATE	MOTOR POWER	EXTERNAL STATİK PRESSURE	CURRENT	ELECTRICAL INFORMATION	FAN DIAMETER	FAN LEVELS	COOLING PAD SURFACE	DRAIN	STORAGE CAPACITY	DIMENSIONS	WEIGHT	OPERATING WEIGHT	DUCT DIMENSIONS
	m <sup>3</sup> /h	kW	Pa	A	V / Hz	mm		mm		lt	mm	kg	kg	mm
F-EVAP 20	20.000	1,5	230	7	220-240/50	630	12	(770x870x100)x4	Otomatik	40	1100x1100x1150	75	115	660x660
F-EVAP 30	30.000	3	320	8	380/50	800	12	(940x910x100)x4	Otomatik	80	1300x1300x1200	120	170	90x900
F-EVAP 40	40.000	4	360	10	380/50	800	12	(1000x1050x100)x4	Otomatik	80	1500x1500x1450	120	170	900x900



## Capacity Calculation

The cooling capacity of evaporative cooling unit is primarily depends on the inlet air temperature and the absolute humidity in it, but is calculated according to the air flow of the fan inside the unit. This fan flow rate is expressed in terms of m<sup>3</sup>/h. As a result of this calculation, the amount of air that the cooling unit will transfer to environment per unit time is determined.

**Formula:**

**Air flow rate of the unit (m<sup>3</sup>/h) = The volume of the enclosed environment to be cooled (m<sup>3</sup>) x Air change rate (1/h)**

### Air Change Rates (1/h)

Definition of Area	Normal Areas	Crowded-Common Areas	High Temperature Areas	Smelly and Dirty Areas
Air Change Rate	20-30	25-40	35-45	44-55

Outdoor Temperature	% Outdoor Relative Humidity								
	%10	%20	%30	%40	%50	%60	%70	%80	%90
10 °C	3,2 °C	4 °C	4,8 °C	5,6 °C	6,4 °C	7,2 °C	8 °C	8,6 °C	9,4 °C
15 °C	6,6 °C	7,1 °C	8,8 °C	9,8 °C	10,8 °C	11,8 °C	12,6 °C	13,4 °C	14,3 °C
20 °C	10,1 °C	11,4 °C	12,8 °C	13,9 °C	15,2 °C	16,2 °C	17,2 °C	18,2 °C	19,2 °C
25 °C	13,4 °C	15 °C	16,6 °C	18 °C	19,4 °C	20,6 °C	21,8 °C	22,9 °C	24 °C
30 °C	16,6 °C	18,6 °C	20,4 °C	22 °C	23,6 °C	25 °C	26,4 °C	27,7 °C	28,9 °C
35 °C	19,8 °C	22,2 °C	24,2 °C	26,2 °C	28 °C	29,6 °C	31 °C	32,4 °C	33,7 °C
40 °C	23 °C	25,6 °C	28,1 °C	30,4 °C	32,3 °C	33,9 °C	-	-	-
45 °C	25,9 °C	29,2 °C	32 °C	34,4 °C	-	-	-	-	-
50 °C	29 °C	32,7 °C	35,8 °C	-	-	-	-	-	-

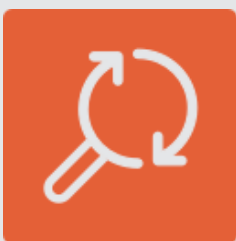

## Sample Selection

According to the table above, when the air change rate is selected appropriately, the outdoor air temperature at 30 °C and 30% humidity, the industrial type evaporative cooling unit can reduce the ambient temperature to 24,2 °C.



***Car park  
Ventilation***

# 75%\*

*\*75% of life losses in fires are caused by smoke poisoning.*

*Therefore, smoke evacuation is vital in closed spaces with a risk of fire*



## System Advantages

### **Benefits for Investors**

- *Since it takes the place of complicated and expensive duct systems, there is a decrease in investment costs. It is a great advantage especially for renovation projects.*
- *Modern aesthetics: The flexible positioning of the jet fans allows for a modern and aesthetic design.*
- *Stylish and tidy design: The system as a whole is more pleasing to the eye, with no obstructions from the duct installation in the field of view.*

### **Benefits for Designers**

- *High flexibility: Allows flexible jet fan placement during new constructions or renovation of multistorey car parks.*
- *No complex duct installation is required.*

### **Benefits for Operators**

- *Easy installation: Jet fans can be installed quickly and easily on the roof of the car park.*
- *Hassle-free installation: Fans can be suspended in the final stage, which means less intersection with other jobs.*
- *Flexible fan positioning is possible.*
- *The energy-efficient Jet Fan System saves up to 80% energy. This reduces operating costs considerably. The focal point of the system is an intelligent control unit that provides energy-efficient, controllable ventilation according to need.*
- *The pressure drop in the ducting system is not experienced, thus reducing the energy drawn by the fan.*
- *Customized as needed: CO (carbon-monoxide) sensors only activate fans that are actually needed. The predefined areas can be ventilated without the entire system running. This feature also helps to reduce operating costs.*
- *High air quality: When using a jet fan, the concentration of pollutants in the air is lower than in conventional ducted systems. The air in the areas where the fans operate is constantly moving, thus increasing the rate of fresh air in all areas.*
- *Jet fan systems for heat and smoke evacuation prevent costly damage. The ceilings are exposed to lower temperatures, and smoke is quickly removed from the building.*
- *Provides optimum safety in case of fire. The quick release of smoke and heat prevents them from splashing into other areas of the car park. Precise smoke control makes it easy for the fire brigade.*



**J-FWA**  
**Axial Jet Fan**

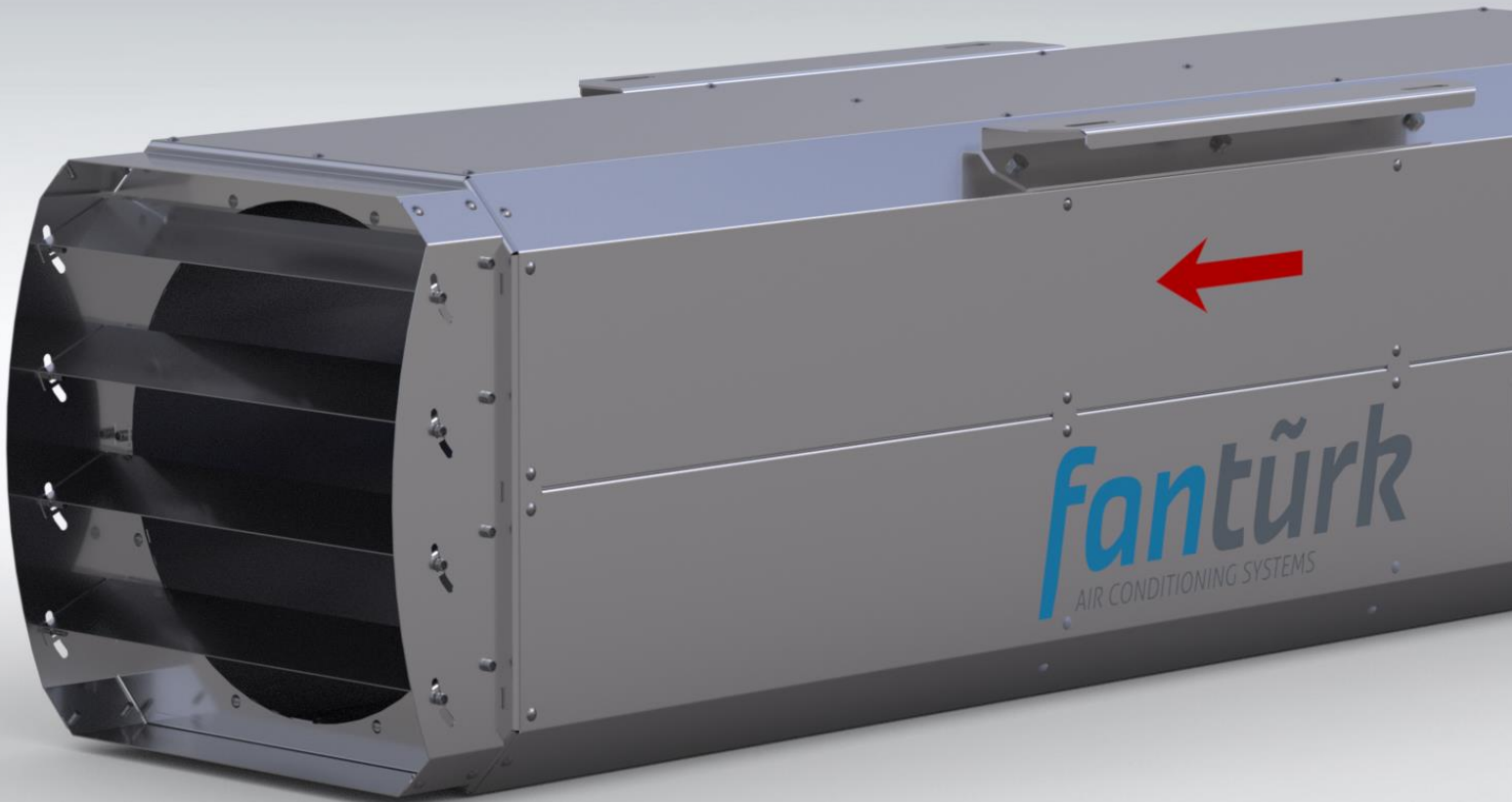

## General Features

*The products have fire-resistant certificate and tested for working for 2 hours at 400 °C in international accredited organizations according to EN 12101-3 standard.*

*It is manufactured between Ø315mm and Ø630mm diameters.*

*According to the project, uni-directional or reversible and two-speed or single-speed options are available.*

### Fan Body

*J-FWA Axial Jet Fan models are manufactured from high quality galvanized steel.*

### Propeller

*The propellers are made of special aluminum alloy with adjustable blade angles or ST 52 steel blades. According to the project, it can operate in the same performance in both blowing directions thanks to its reversible blade structure. Complies with international standards.*

### Motor

*It is manufactured as standard (380 V - 50 Hz) or other voltages and frequencies (400/415/440 V -50 Hz) on request. As a standard, Class H, S1+S2, IP55 single-speed or double-speed motors with a resistance of 2 hours to 400 degrees or 2 hours to 300 degrees are used*

### Accessories

*In this series, the sound volume increases due to the high air outlet velocities and therefore jet fans are used as standard with the silencer.*

### Sliding System

*Thanks to its unique sliding system design, disassembly or maintenance time is minimized with easy intervention to the motor*

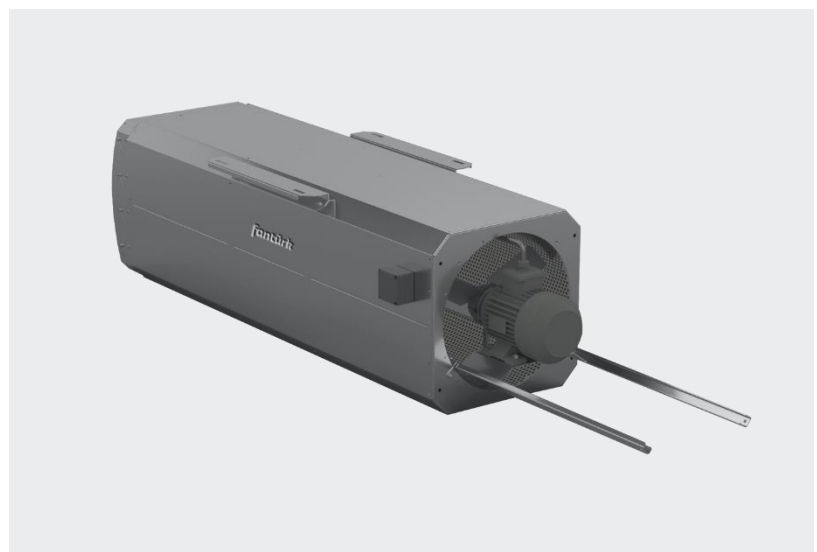



## Technical Specifications

# AXIAL JET FAN

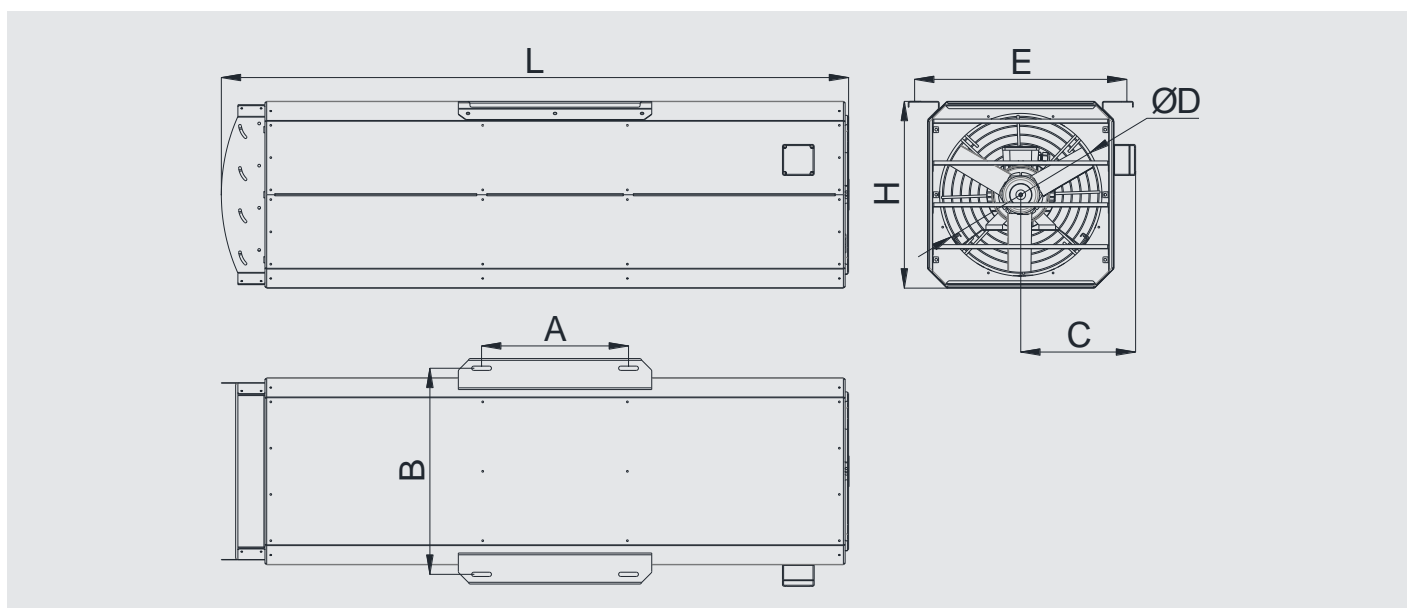
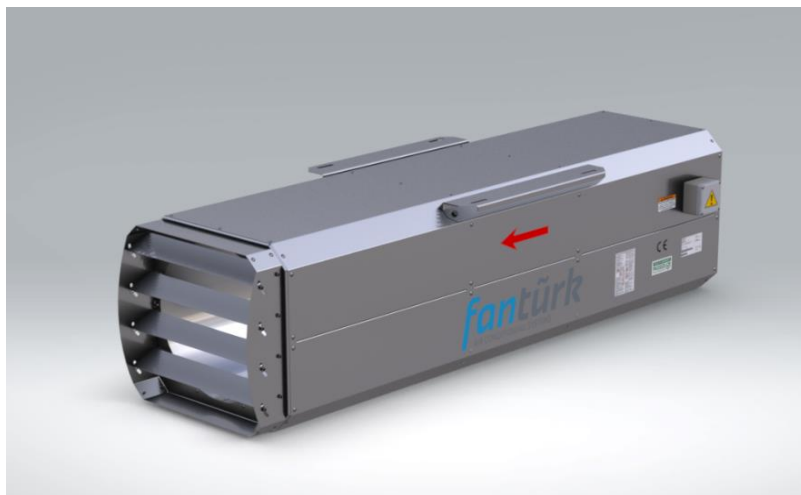

MODEL	A	B	C	D	E	H	L	THRUST	MAX. FLOW RATE	POWER	MOTOR SPEED	MAX. AIR VELOCITY	SOUND PRESSURE LEVEL	WEIGHT
	mm	mm	mm	mm	mm	mm	mm	N	m <sup>3</sup> /h	kW	rpm	m/s	dB(A)	kg
J-FWA 315	380	445	255	335	495	395	1575	24	4500	0,8/0,2	3000/1500	16	69/54	65
J-FWA 355	380	485	275	375	535	435	1580	40	6500	1,1/0,25	3000/1500	18	74/59	85
J-FWA 400	380	530	295	420	580	480	1590	60	9000	1,5/0,37	3000/1500	20	75/60	100
J-FWA 450	380	580	320	470	630	530	1600	85	12000	2,2/0,5	3000/1500	21	82/67	140
J-FWA 500	380	630	345	520	680	580	1980	150	17500	3,8/1	3000/1500	25	90/75	170
J-FWA 560	380	690	375	580	740	640	2160	235	24000	6/1,5	3000/1500	28	91/76	230



# R-FWA Radial Jet Fan

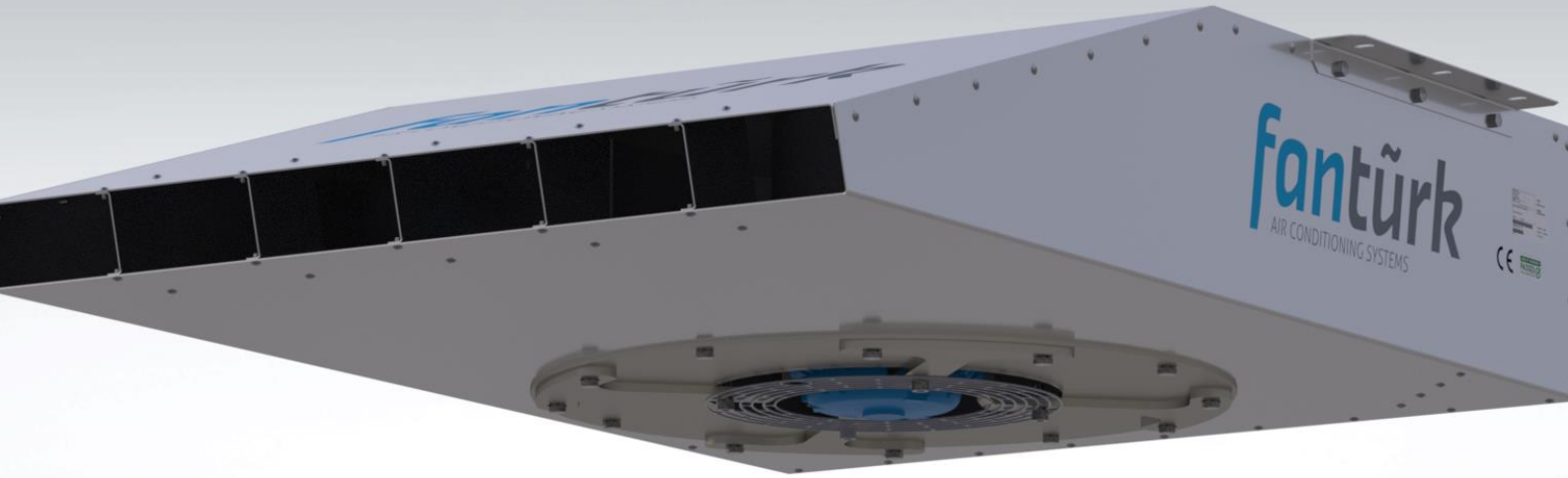

## Technical Specifications

### RADIAL JET FAN

The R-FWA Series radial jet fans have fire-resistant certificate and tested for working for 2 hours at 400 °C in international accredited organizations according to EN 12101-3 standard.

J-FWA Axial Jet Fan models are manufactured from high quality galvanized steel. The radial induction fan inside the case is made of S235 quality steel. It is manufactured as standard (380 V - 50 Hz) or other voltages and frequencies (400/415/440 V - 50 Hz) on request. As a standard, Class H, S1+S2, IP55 single-speed or double-speed motors with a resistance of 2 hours to 400 degrees are used. In the motor mounting, a special pad-mounted connection type is used.

#### Usage Areas

Can be used in car park ventilation systems with low ceiling heights.

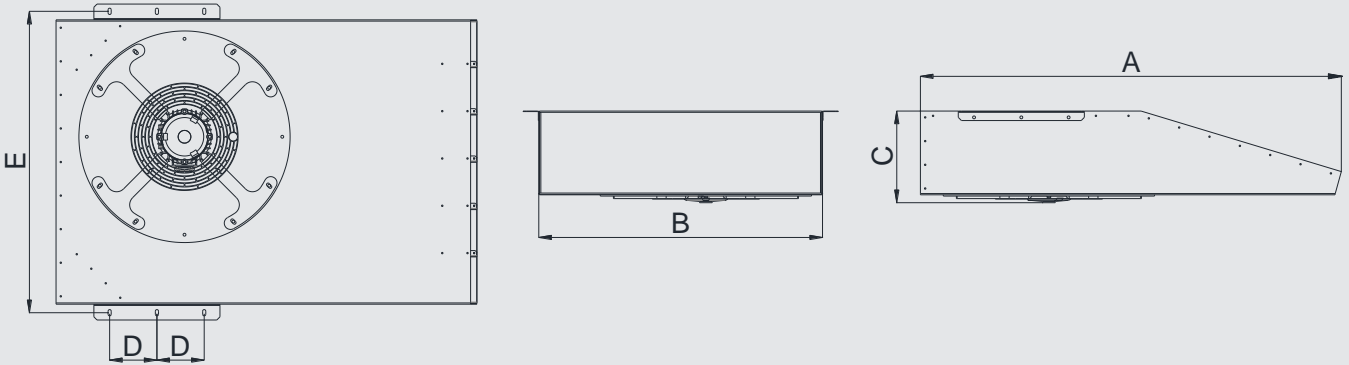
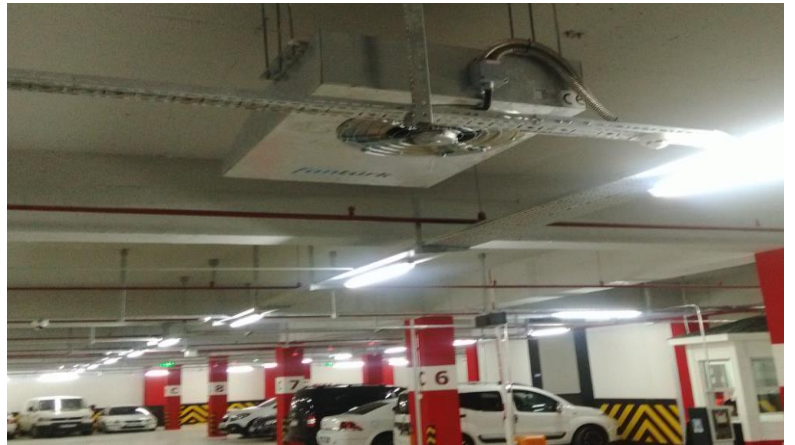
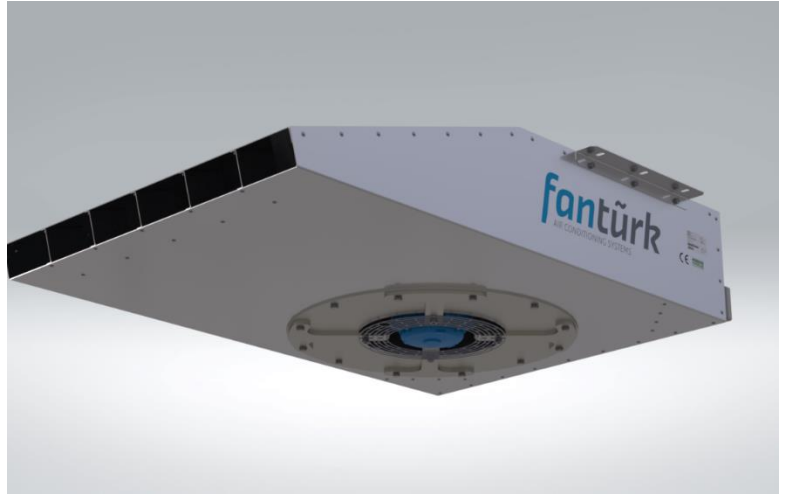

MODEL	A	B	C	D	E	THRUST	MAX. FLOW RATE	MOTOR POWER	MOTOR SPEED	MAX. AIR VELOCITY	SOUND PRESSURE LEVEL	WEIGHT
	mm	mm	mm	mm	mm	N	m <sup>3</sup> /h	kW	rpm	m/s	dB(A)	kg
R-FWA 400	1335	900	290	150	954	63/28	6680	1,4/0,33	1500/750	24	73/56	83

## Automation Panel and Control System



Automation panel is responsible for operating in accordance with the ventilation scenarios processed. PLC (Programmable Logic Card) which is carried by all mechanical devices (axial fans, jet fans, air / smoke dampers, doors etc.) in the system according to the signals coming from the carbon monoxide detection system and / or fire / smoke detection system which analyzes the situation in the parking lot.



Jet fans operate at 1. Motor Speed for daily ventilation according to the signals from the gas sensors or 2. Motor Speed according to the signals from the fire / smoke detection system.

Floor dampers are closed and opened according to the scenario written in order to prevent harmful gas and smoke from reaching the other floors in case of fire.



Fresh air and smoke exhaust fans are activated according to the signals from the gas and fire / smoke detection systems and exhaust of harmful gas is provided.

It works fully compatible with gas sensors and smoke / fire detection systems used in the parking lot.



## CFD Analysis

Car park ventilation projects with jet fans should be supported by computational fluid dynamics analysis. The CFD analysis is very important for the accuracy of the project work, the precise determination of the jet fan locations, and the control of the position of the exhaust and fresh air shafts.

After the 3D modeling of the car park, the analysis should be prepared with fire simulation and boundary conditions prepared in accordance with BS 7346-7 standard. The situation of the car park in case of a possible fire or evacuation of the exhaust gases formed in the building is examined with this simulation.

This provides preliminary information on how the air flow and smoke evacuation will actually behave.

These analyzes should be performed by CFX, Flow Simulation, PyroSim or similar internationally recognized software. The number and layout of the jet fans should be optimized according to the simulation result.

### By CFD Analysis;

- 1.7m above ground density, visibility and air movement
- Temperature distribution in the parking lot in case of fire,
- Details of the air flow in the parking lot,
- Air velocity profiles are examined.

**Smoke Analysis**

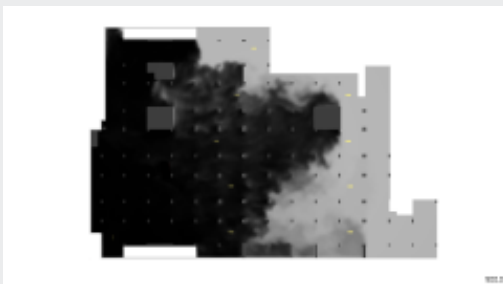

**Visibility Range Analysis**

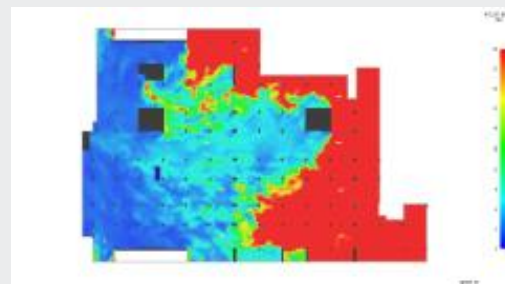

**Air Velocity Analysis**

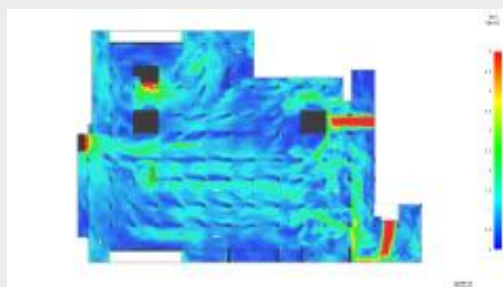

**Temperature Analysis**

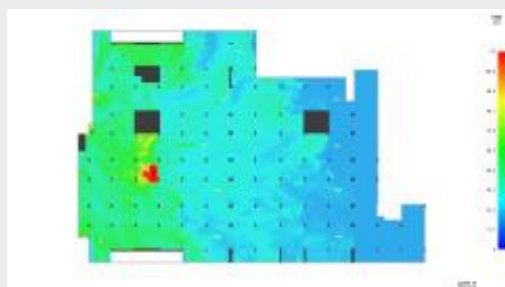

The analyzes are performed according to ASHRAE, BS 7346-7, NFPA 130 standards.



*P-FWA  
Axial  
Fresh/Exhaust Air  
Fan*



## Technical Specifications

### AXIAL FRESH/EXHAUST AIR FAN

P-FWA series axial fresh /exhaust air fans are the ideal fans to meet the fresh air requirement in ventilation systems where high air flow is required. Thanks to their compact construction, they can be installed directly in air ducts, shaft, roof floor, any position required. P-FWA axial fans have high performance, trouble-free operation.

With wide selection of models, P-FWA models offer working range of 4000 m<sup>3</sup>/h – 140.000 m<sup>3</sup>/h in different pressure range.

It is manufactured between Ø400mm and Ø1250mm diameters. The body is made of high quality, corrosion-resistant galvanized steel. The propellers are made of special aluminum alloy with adjustable blade angles. It is manufactured as standard (380 V - 50 Hz) or other voltages and frequencies (400/415/440 V - 50 Hz) on request. Motors can be single-speed or double speed and have Class H, S1, IP55 insulation. The sound level can be controlled by adding a silencer at the sensitive points.

Optionally, it can be manufactured with Ex-Proof feature.

#### Usage Areas

Can be used in all kinds of industrial, office, shopping mall, hospital, parking and residential ventilation to meet the fresh air requirement.

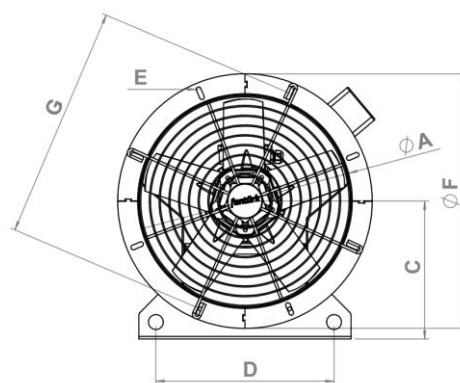
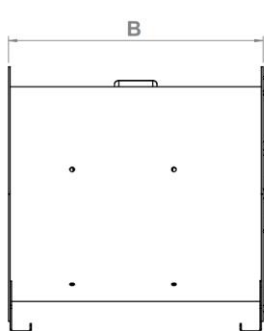
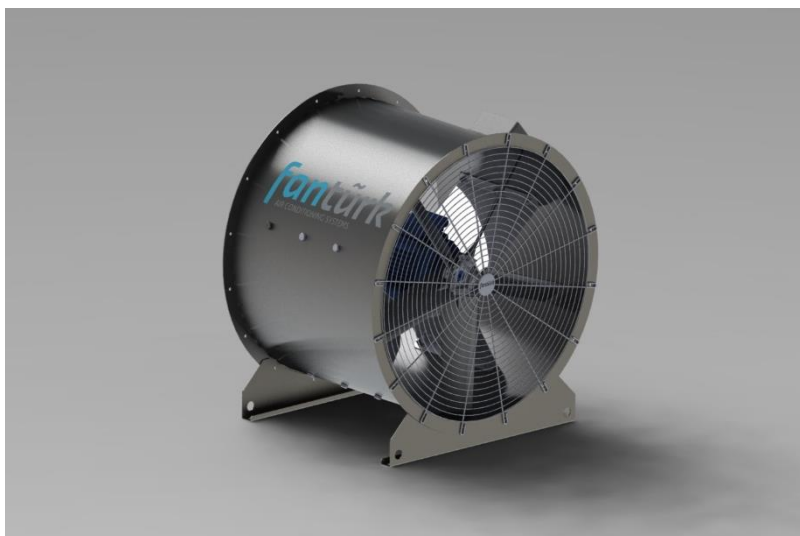

	A	B	C	D	E	F	G	VOLTAGE	FREQUENCY
MODEL	mm	mm	mm	mm	mm	mm	mm	V	Hz
P-FWA 400	400	500	275	320	8x11x31	500	450	380	50
P-FWA 450	450	500	300	370	8x11x31	550	500	380	50
P-FWA 500	500	600	325	420	8x11x31	600	550	380	50
P-FWA 560	560	600	355	480	8x11x31	660	610	380	50
P-FWA 630	630	600	390	550	8x11x31	730	680	380	50
P-FWA 710	710	600	430	630	16x11x31	810	760	380	50
P-FWA 800	800	650	475	720	16x11x31	900	850	380	50
P-FWA 900	900	750	525	720	16x11x31	1000	950	380	50
P-FWA 1000	1000	800	595	820	16x11x31	1100	1050	380	50
P-FWA 1120	1120	900...950	655	920	16x11x31	1220	1170	380	50
P-FWA 1250	1250	950	720	1020	16x11x31	1350	1300	380	50



# Y-FWA Axial Smoke Exhaust Fan





## Technical Specifications

### AXIAL SMOKE EXHAUST FAN

Y-FWA series axial smoke exhaust fans are the ideal fans to meet the need to exhaust fire smoke in ventilation systems. Thanks to their compact construction, they can be installed directly in air ducts, shaft, roof floor, any position required. The products have fire-resistant certificate and tested for working for 2 hours at 400 °C and 2 hours at 300 °C in international accredited organizations according to EN 12101-3 standard. With wide selection of models, Y-FWA models offer working range of 4000 m<sup>3</sup>/h – 140.000 m<sup>3</sup>/h in different pressure range.

It is manufactured between Ø400mm and Ø1250mm diameters. The body is made of high quality, corrosion-resistant galvanized steel. The propellers are made of special aluminum alloy with adjustable blade angles. It is manufactured as standard (380 V - 50 Hz) or other voltages and frequencies (400/415/440 V - 50 Hz) on request. Motors can be single-speed or double speed and have Class H, S1, IP55 insulation. The sound level can be controlled by adding a silencer at the sensitive points.

#### Usage Areas

Can be used to meet the smoke exhaust requirement in ventilations systems of all kinds of industrial buildings, shopping malls, residences, hotels, hospitals, schools, offices, car parks and residences.

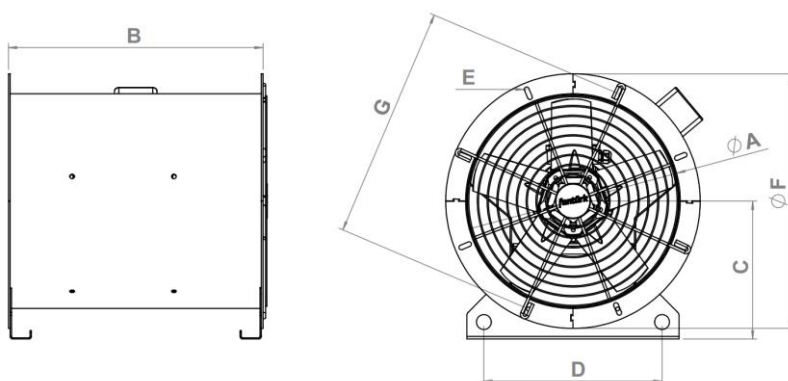

MODEL	A	B	C	D	E	F	G	VOLTAGE	FREQUENCY	WORKING ENVIRONMENT
	mm	mm	mm	mm	mm	mm	mm	V	Hz	
Y-FWA 400	400	500	275	320	8x11x31	500	450	380	50	300 °C / 2 Hour
Y-FWA 450	450	500	300	370	8x11x31	550	500	380	50	300 °C / 2 Hour
Y-FWA 500	500	600	325	420	8x11x31	600	550	380	50	300 °C / 2 Hour
Y-FWA 560	560	600	355	480	8x11x31	660	610	380	50	300 °C / 2 Hour
Y-FWA 630	630	600	390	550	8x11x31	730	680	380	50	300 °C / 2 Hour
Y-FWA 710	710	600	430	630	16x11x31	810	760	380	50	300 °C / 2 Hour
Y-FWA 800	800	650	475	720	16x11x31	900	850	380	50	300 °C / 2 Hour
Y-FWA 900	900	750	525	720	16x11x31	1000	950	380	50	300 °C / 2 Hour
Y-FWA 1000	1000	800	595	820	16x11x31	1100	1050	380	50	300 °C / 2 Hour
Y-FWA 1120	1120	900...950	655	920	16x11x31	1220	1170	380	50	300 °C / 2 Hour
Y-FWA 1250	1250	950	720	1020	16x11x31	1350	1300	380	50	300 °C / 2 Hour



***H-FWA***  
***Cabinet Type***  
***Axial Fan***



## Technical Specifications

### CABINET TYPE AXIAL FAN

H-FWA series axial fresh air fans are the ideal fans to meet the fresh air requirement in ventilation systems where high air flow is required. Thanks to their compact construction, they can be installed directly on roof floor. H-FWA axial fans have high performance, trouble-free operation.

With wide selection of models, P-FWA models offer working range of 4000 m<sup>3</sup>/h – 140.000 m<sup>3</sup>/h in different pressure range.

It is manufactured between Ø400mm and Ø1250mm diameters. The body is made of high quality, corrosion-resistant galvanized steel. 50 mm rockwool and double walled cell structure are used for sound insulations. The propellers are made of special aluminum alloy with adjustable blade angles. It is manufactured as standard (380 V - 50 Hz) or other voltages and frequencies (400/415/440 V - 50 Hz) on request. Motors can be single-speed or double speed and have Class H, S1, IP55 insulation. The sound level can be controlled by adding a silencer at the sensitive points.

Optionally, it can be manufactured with Ex-Proof feature.

#### Usage Areas

It can be used in all kinds of industrial, office, shopping mall, hospital, factory, parking lot and residential ventilation and pressurization systems.

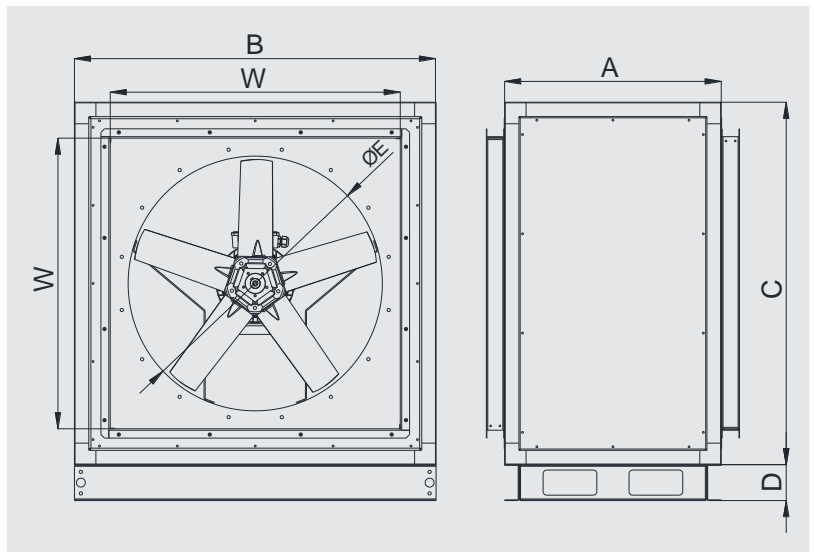

	A	B	C	D	E	W x H	VOLTAGE	FREQUENCY
MODEL	mm	mm	mm	mm	mm	mm	V	Hz
H-FWA 400	550	700	700	150	400	650x650	380	50
H-FWA 450	550	750	750	150	450	650x650	380	50
H-FWA 500	650	800	800	150	500	750x750	380	50
H-FWA 560	650	860	860	150	560	810x810	380	50
H-FWA 630	650	930	930	150	630	880x880	380	50
H-FWA 710	650	1010	1010	150	710	960x960	380	50
H-FWA 800	650	1100	1100	150	800	1050x1050	380	50
H-FWA 900	800	1200	1200	150	900	1150x1150	380	50
H-FWA 1000	850	1300	1300	150	1000	1250x1250	380	50
H-FWA 1120	850...1000	1420	1420	150	1120	1370x1370	380	50
H-FWA 1250	1000	1540	1540	150	1250	1490x1490	380	50

## Performance Curves of Devices with Axial Fan

**P-FWA 400**  
**Y-FWA 400**  
**H-FWA 400**  
**Ç-FWA 400**

Nos. of Blades 3  
 Hub Size 6  
 Pitch Angle 45°  
 Nos. of Poles 2  
 Material Aluminum

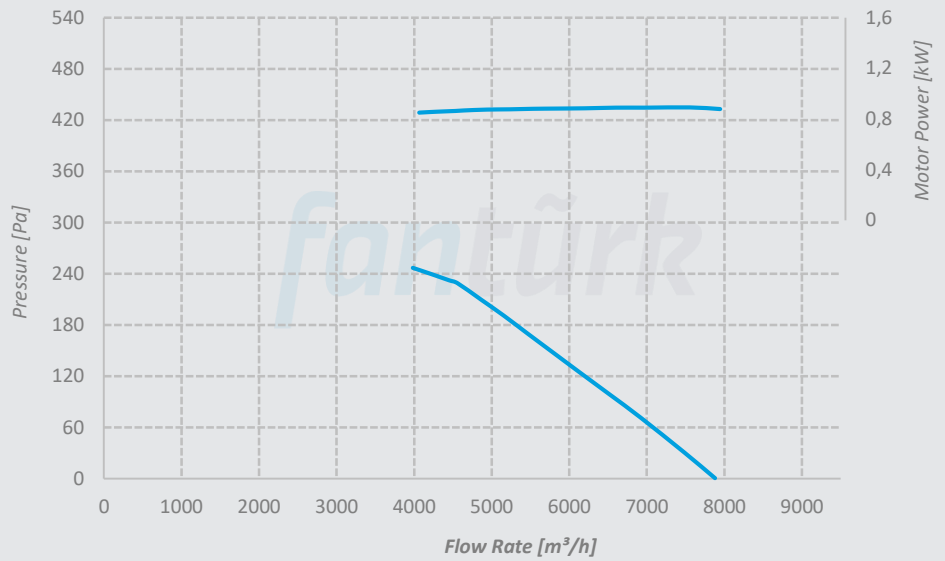

**P-FWA 400**  
**Y-FWA 400**  
**H-FWA 400**  
**Ç-FWA 400**

Nos. of Blades 3  
 Hub Size 6  
 Pitch Angle 45°  
 Nos. of Poles 4  
 Material Aluminum

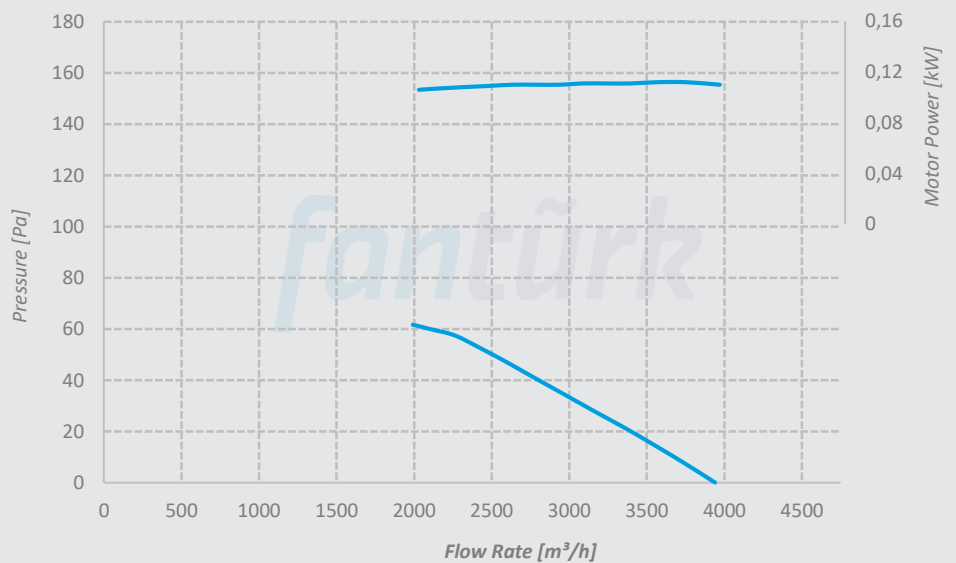

**P-FWA 400**  
**Y-FWA 400**  
**H-FWA 400**  
**Ç-FWA 400**

Nos. of Blades 3  
 Hub Size 6  
 Pitch Angle 45°  
 Nos. of Poles 6  
 Material Aluminum

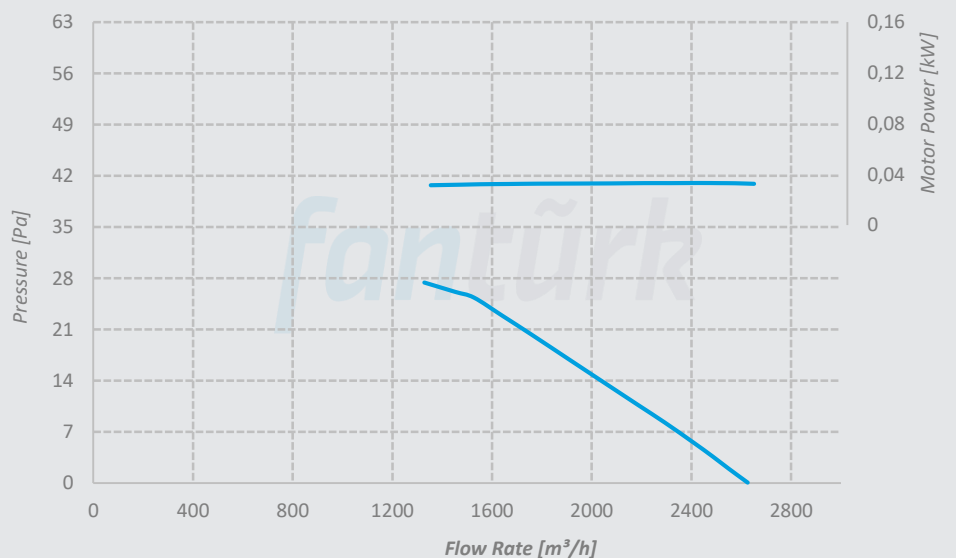

## Performance Curves

**P-FWA 400**  
**Y-FWA 400**  
**H-FWA 400**  
**Ç-FWA 400**

Nos. of Blades 6  
 Hub Size 6  
 Pitch Angle 45°  
 Nos. of Poles 2  
 Material Aluminum

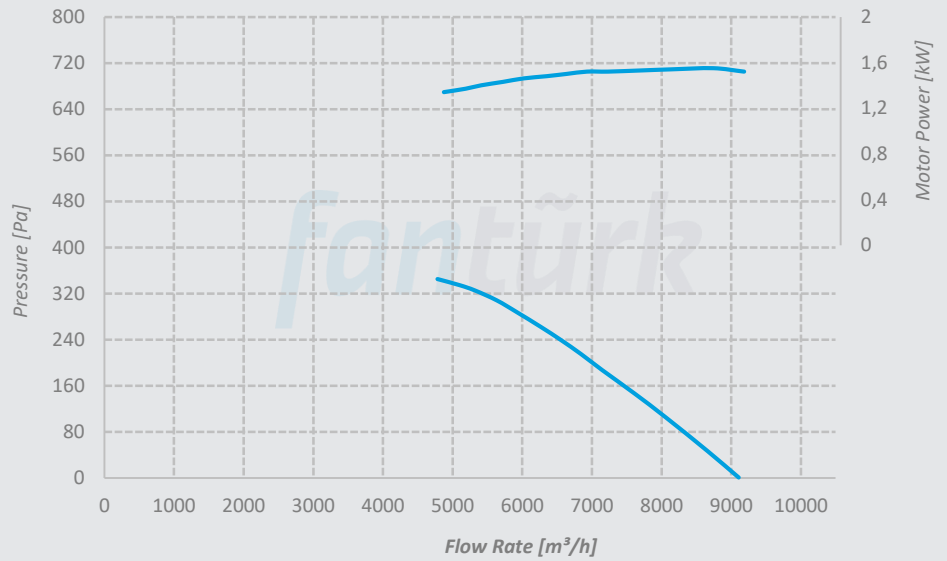

**P-FWA 400**  
**Y-FWA 400**  
**H-FWA 400**  
**Ç-FWA 400**

Nos. of Blades 6  
 Hub Size 6  
 Pitch Angle 45°  
 Nos. of Poles 4  
 Material Aluminum

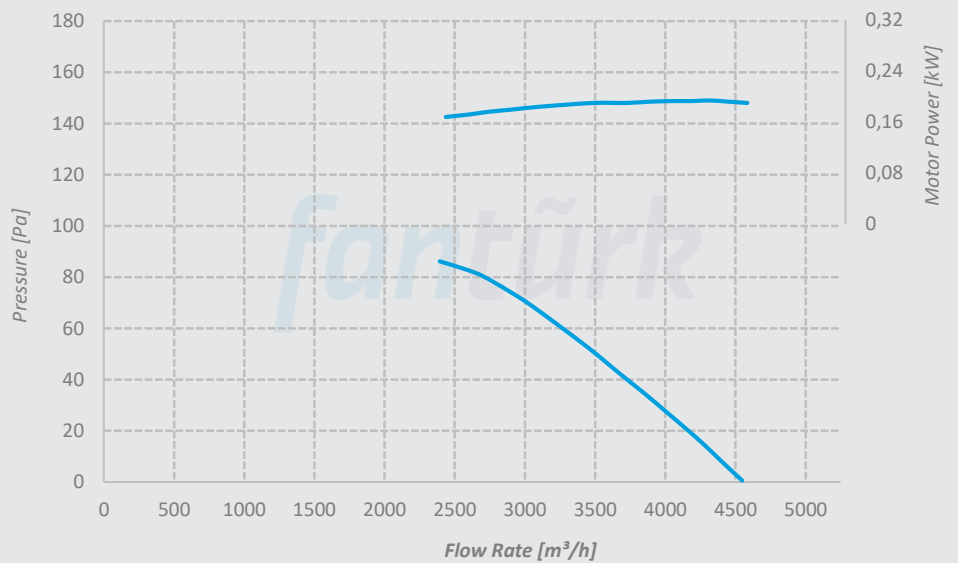

**P-FWA 400**  
**Y-FWA 400**  
**H-FWA 400**  
**Ç-FWA 400**

Nos. of Blades 6  
 Hub Size 6  
 Pitch Angle 45°  
 Nos. of Poles 6  
 Material Aluminum

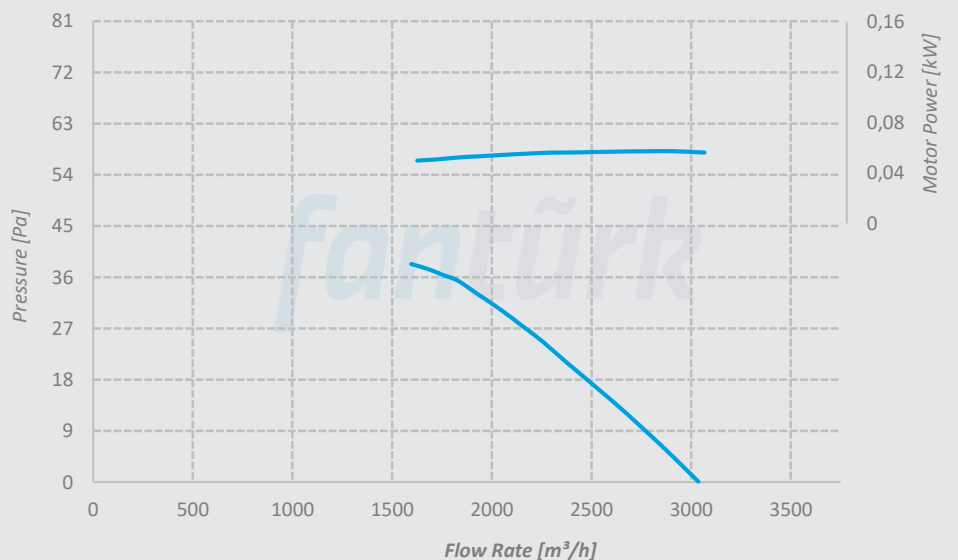

# Performance Curves

## P-FWA 400 Y-FWA 400 H-FWA 400 Ç-FWA 400

Nos. of Blades 5  
Hub Size 5  
Nos. of Poles 2  
Material Aluminum  
Pitch Angle

- 25°    — 30°    — 32,5°
- 35°    — 37,5°    — 40°
- 45°    — 50°

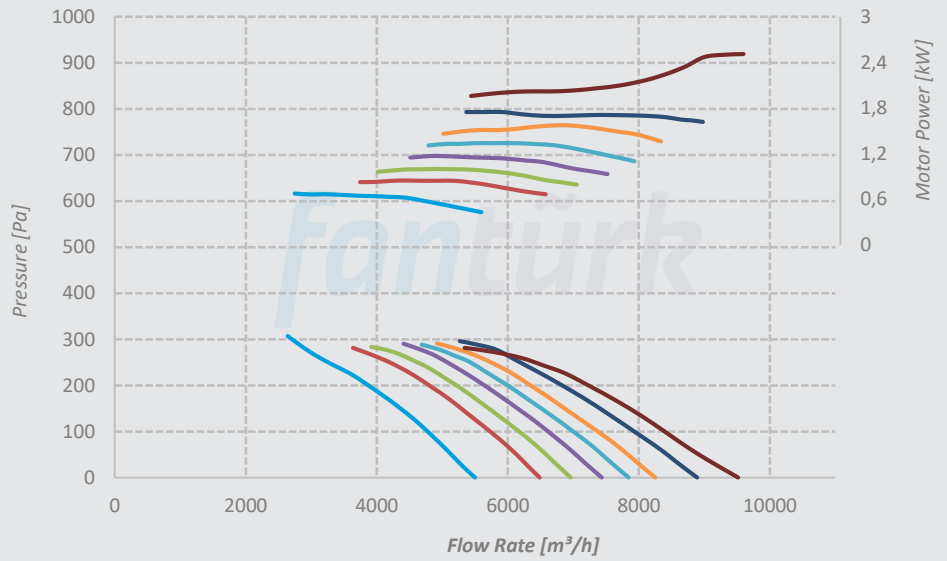

## P-FWA 400 Y-FWA 400 H-FWA 400 Ç-FWA 400

Nos. of Blades 5  
Hub Size 5  
Nos. of Poles 4  
Material Aluminum  
Pitch Angle

- 25°    — 30°    — 32,5°
- 35°    — 37,5°    — 40°
- 45°    — 50°

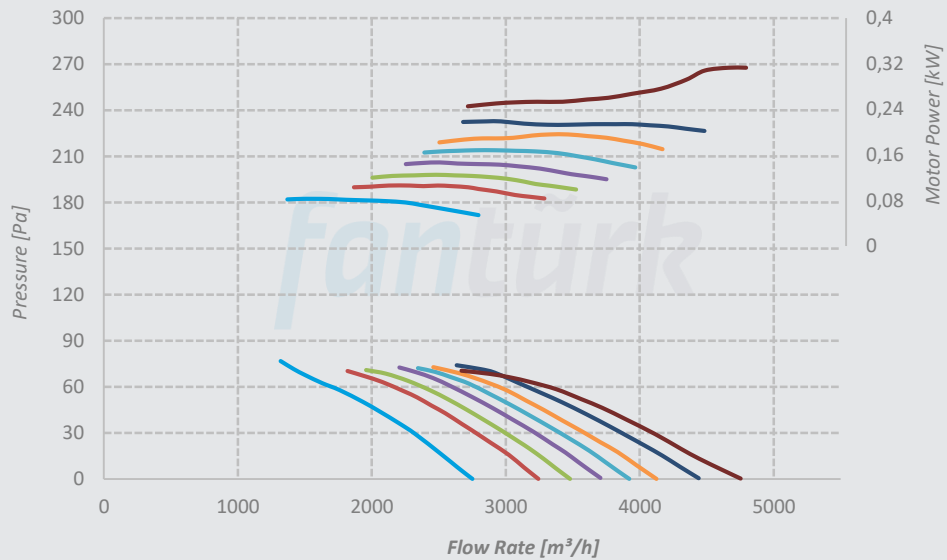

## P-FWA 400 Y-FWA 400 H-FWA 400 Ç-FWA 400

Nos. of Blades 5  
Hub Size 5  
Nos. of Poles 6  
Material Aluminum  
Pitch Angle

- 25°    — 30°    — 32,5°
- 35°    — 37,5°    — 40°
- 45°    — 50°

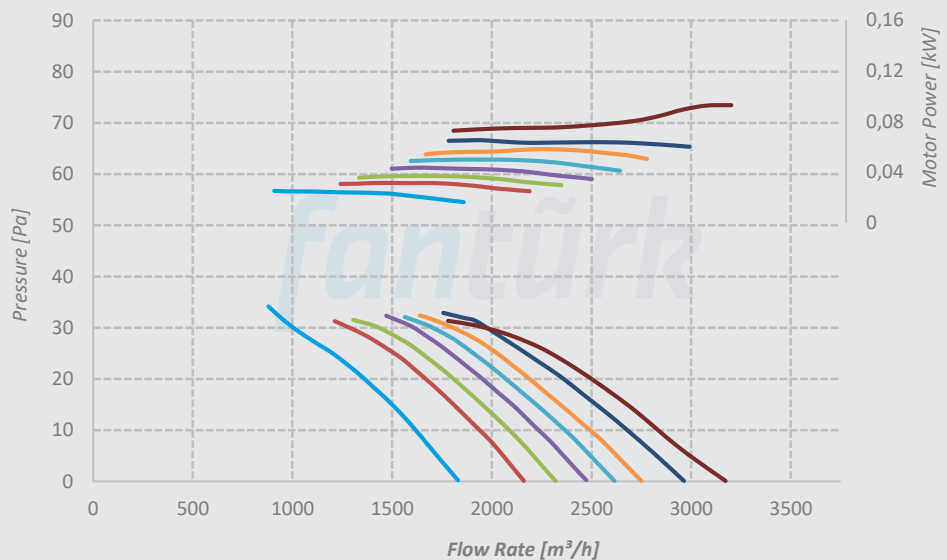

## Performance Curves

**P-FWA 450**  
**Y-FWA 450**  
**H-FWA 450**  
**Ç-FWA 450**

Nos. of Blades 3  
 Hub Size 6  
 Pitch Angle 45°  
 Nos. of Poles 2  
 Material Aluminum

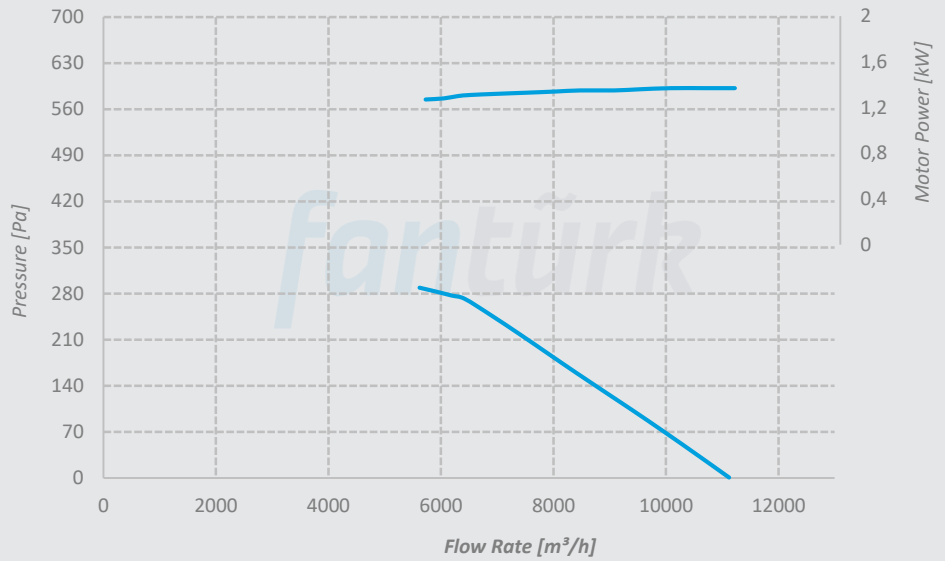

**P-FWA 450**  
**Y-FWA 450**  
**H-FWA 450**  
**Ç-FWA 450**

Nos. of Blades 3  
 Hub Size 6  
 Pitch Angle 45°  
 Nos. of Poles 4  
 Material Aluminum

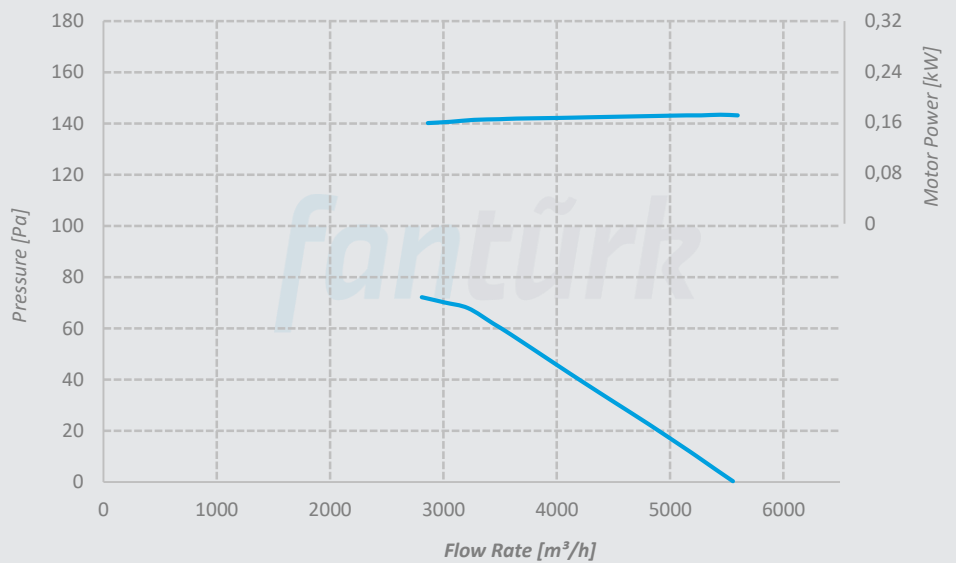

**P-FWA 450**  
**Y-FWA 450**  
**H-FWA 450**  
**Ç-FWA 450**

Nos. of Blades 3  
 Hub Size 6  
 Pitch Angle 45°  
 Nos. of Poles 6  
 Material Aluminum

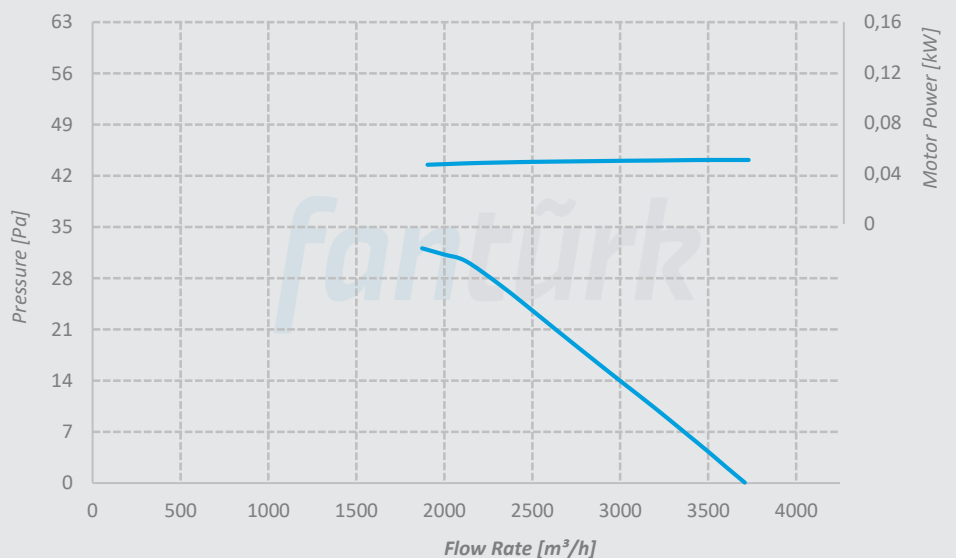

## Performance Curves

**P-FWA 450**  
**Y-FWA 450**  
**H-FWA 450**  
**Ç-FWA 450**

Nos. of Blades 6  
 Hub Size 6  
 Pitch Angle 45°  
 Nos. of Poles 2  
 Material Aluminum

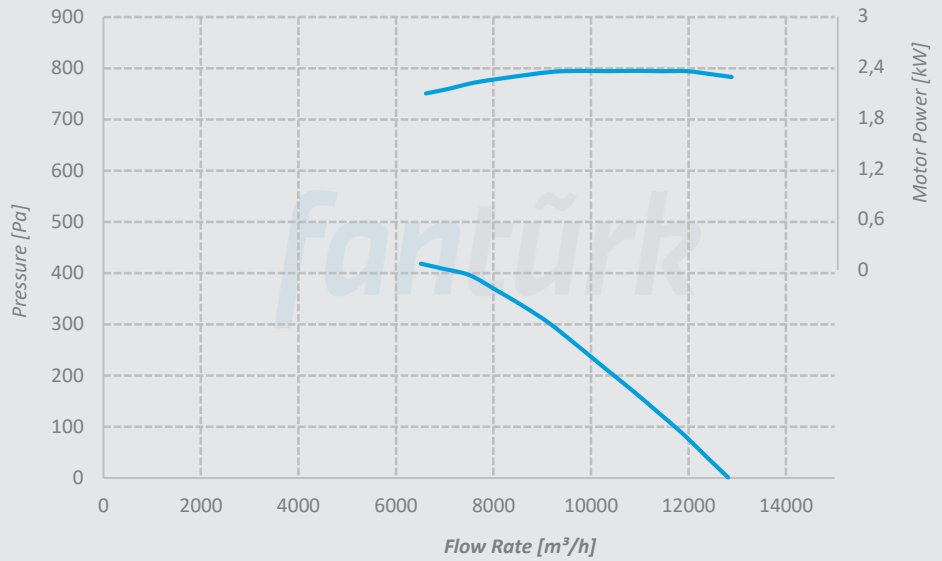

**P-FWA 450**  
**Y-FWA 450**  
**H-FWA 450**  
**Ç-FWA 450**

Nos. of Blades 6  
 Hub Size 6  
 Pitch Angle 45°  
 Nos. of Poles 4  
 Material Aluminum

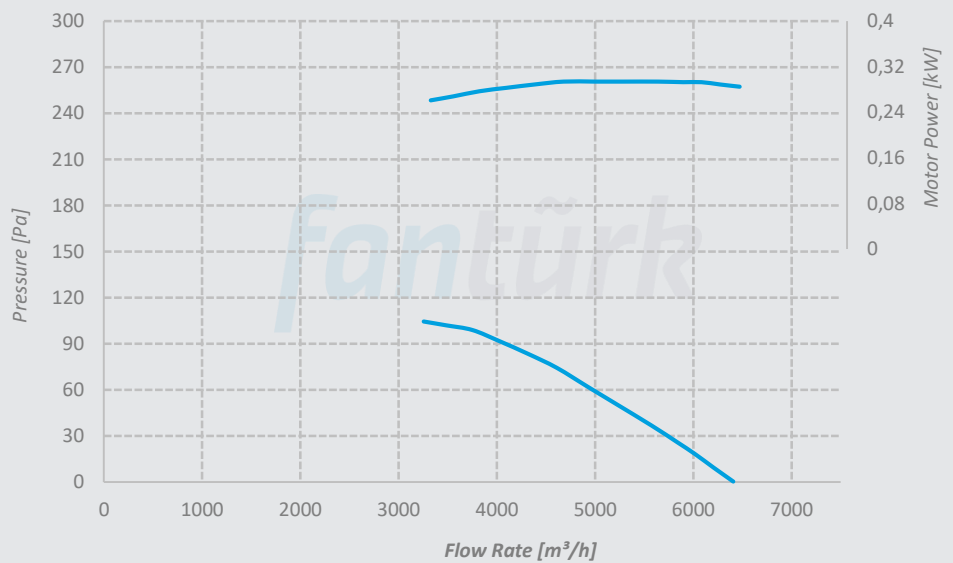

**P-FWA 450**  
**Y-FWA 450**  
**H-FWA 450**  
**Ç-FWA 450**

Nos. of Blades 6  
 Hub Size 6  
 Pitch Angle 45°  
 Nos. of Poles 6  
 Material Aluminum

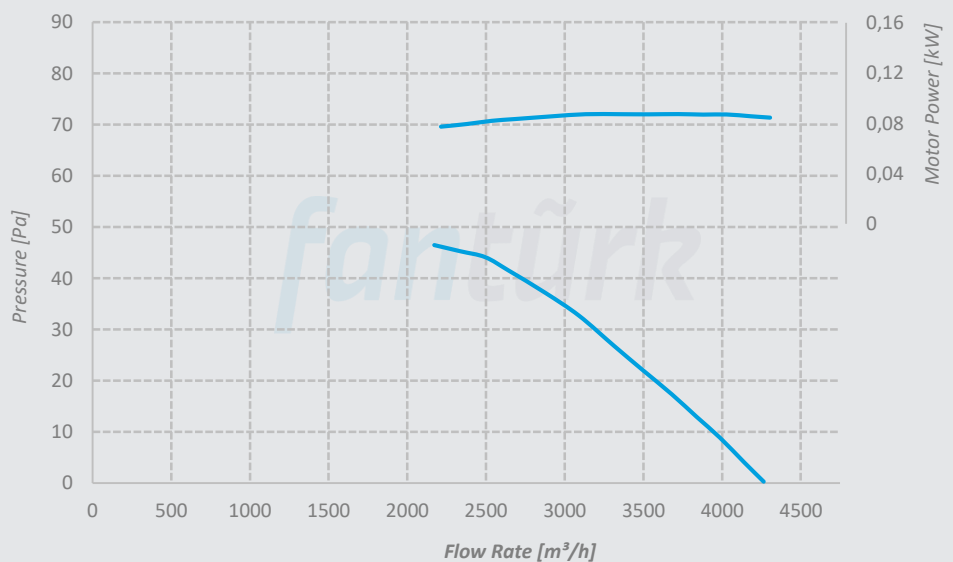



# Performance Curves

**P-FWA 450**  
**Y-FWA 450**  
**H-FWA 450**  
**Ç-FWA 450**

Nos. of Blades 5  
 Hub Size 5  
 Nos. of Poles 2  
 Material Aluminum  
 Pitch Angle

25° 30° 32,5°  
 35° 37,5° 40°  
 45° 50°

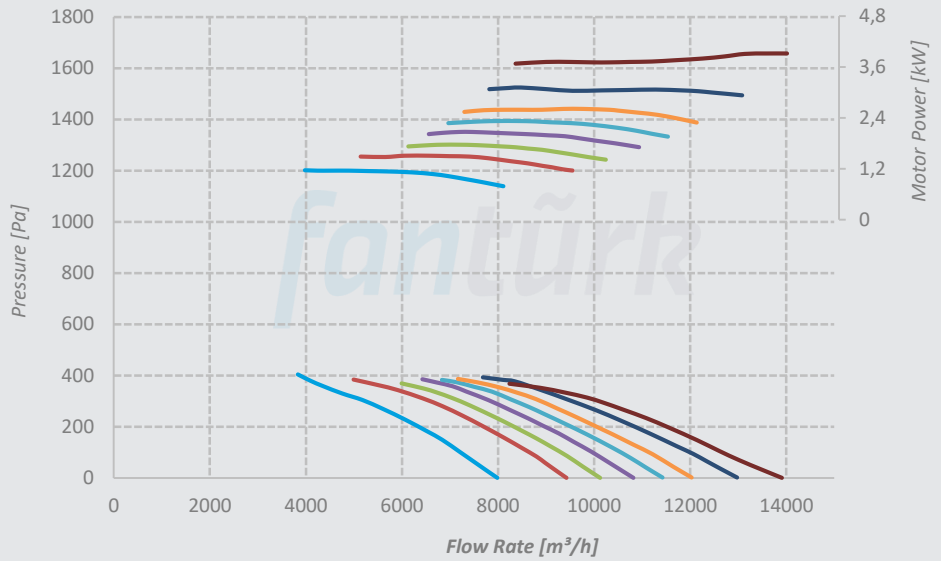

**P-FWA 450**  
**Y-FWA 450**  
**H-FWA 450**  
**Ç-FWA 450**

Nos. of Blades 5  
 Hub Size 5  
 Nos. of Poles 4  
 Material Aluminum  
 Pitch Angle

25° 30° 32,5°  
 35° 37,5° 40°  
 45° 50°

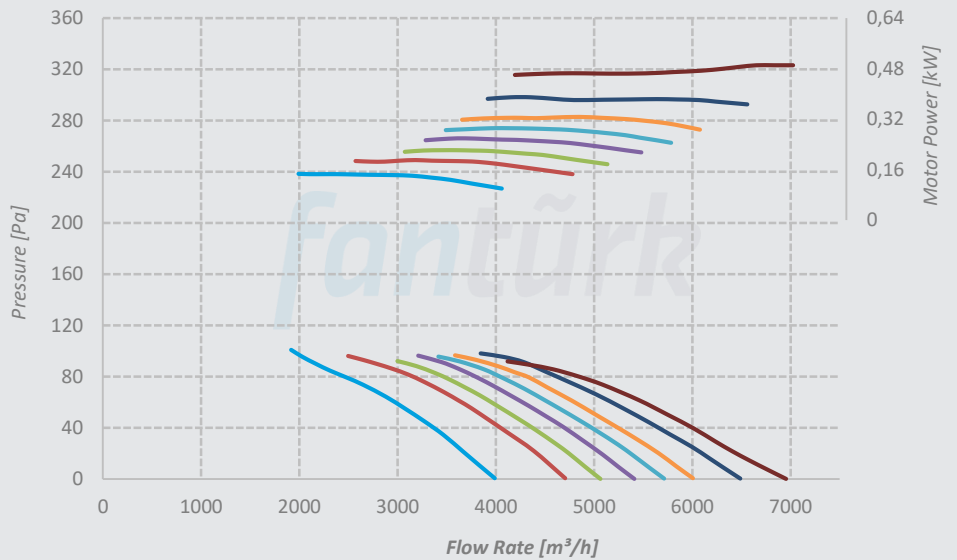

**P-FWA 450**  
**Y-FWA 450**  
**H-FWA 450**  
**Ç-FWA 450**

Nos. of Blades 5  
 Hub Size 5  
 Nos. of Poles 6  
 Material Aluminum  
 Pitch Angle

25° 30° 32,5°  
 35° 37,5° 40°  
 45° 50°

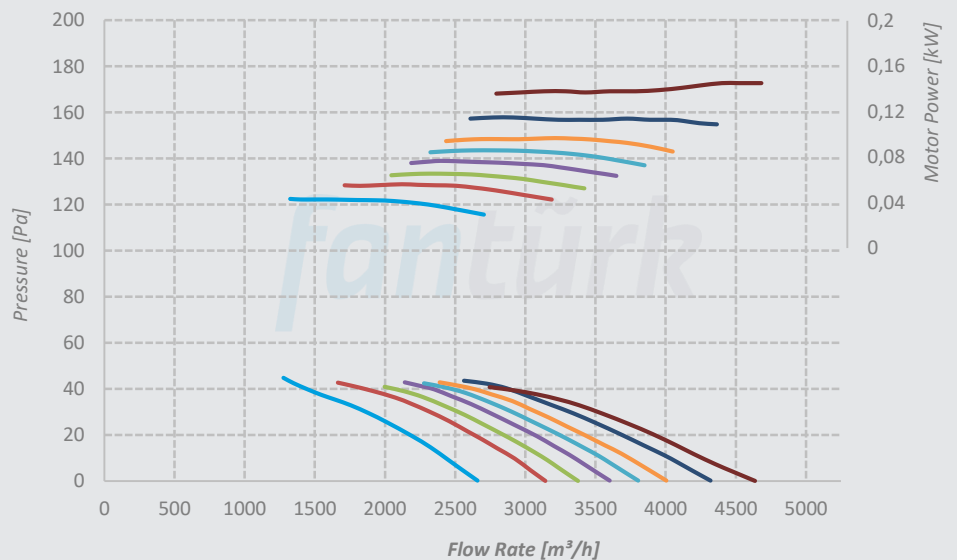

## Performance Curves

**P-FWA 500**  
**Y-FWA 500**  
**H-FWA 500**  
**Ç-FWA 500**

Nos. of Blades 3  
 Hub Size 6  
 Pitch Angle 45°  
 Nos. of Poles 2  
 Material Aluminum

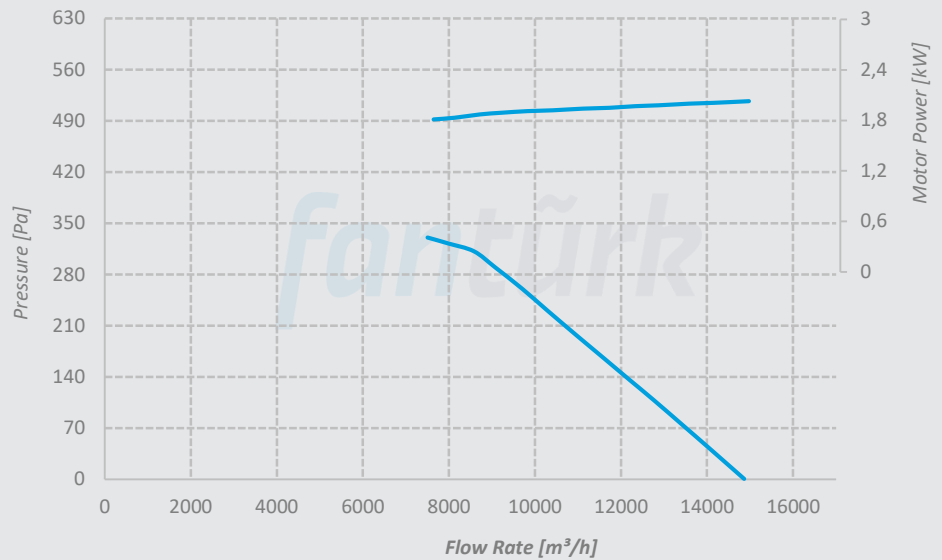

**P-FWA 500**  
**Y-FWA 500**  
**H-FWA 500**  
**Ç-FWA 500**

Nos. of Blades 3  
 Hub Size 6  
 Pitch Angle 45°  
 Nos. of Poles 4  
 Material Aluminum

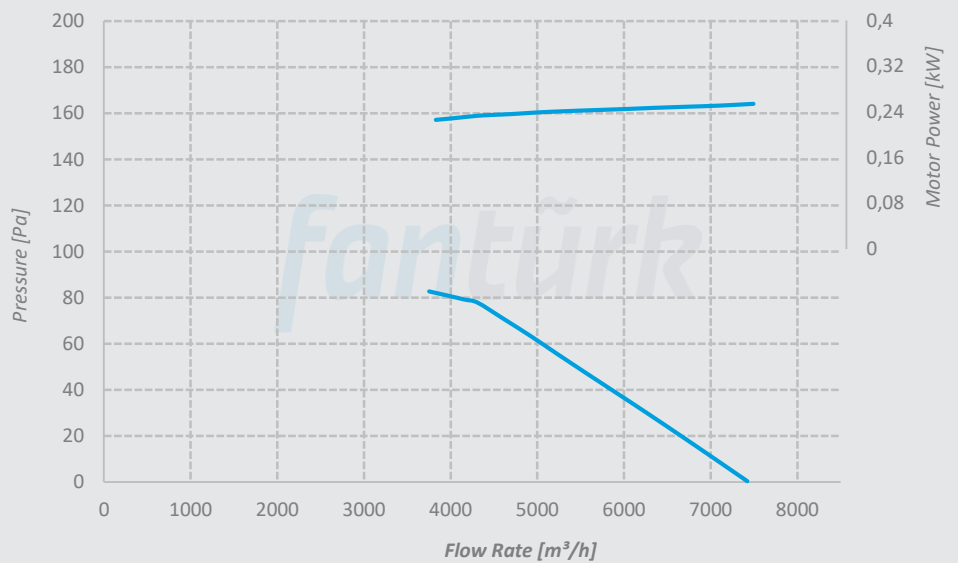

**P-FWA 500**  
**Y-FWA 500**  
**H-FWA 500**  
**Ç-FWA 500**

Nos. of Blades 3  
 Hub Size 6  
 Pitch Angle 45°  
 Nos. of Poles 6  
 Material Aluminum

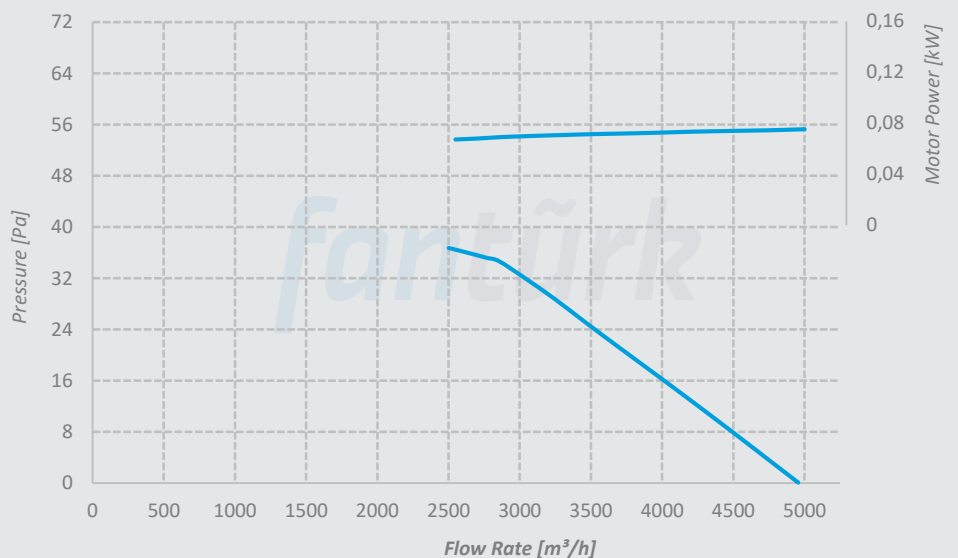

## Performance Curves

**P-FWA 500**  
**Y-FWA 500**  
**H-FWA 500**  
**Ç-FWA 500**

Nos. of Blades 6  
 Hub Size 6  
 Pitch Angle 45°  
 Nos. of Poles 2  
 Material Aluminum

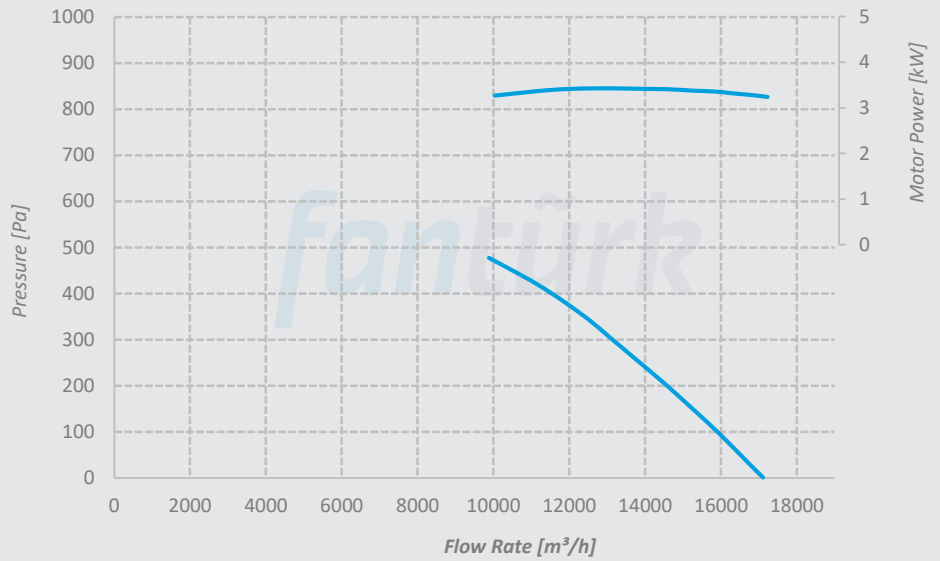

**P-FWA 500**  
**Y-FWA 500**  
**H-FWA 500**  
**Ç-FWA 500**

Nos. of Blades 6  
 Hub Size 6  
 Pitch Angle 45°  
 Nos. of Poles 4  
 Material Aluminum

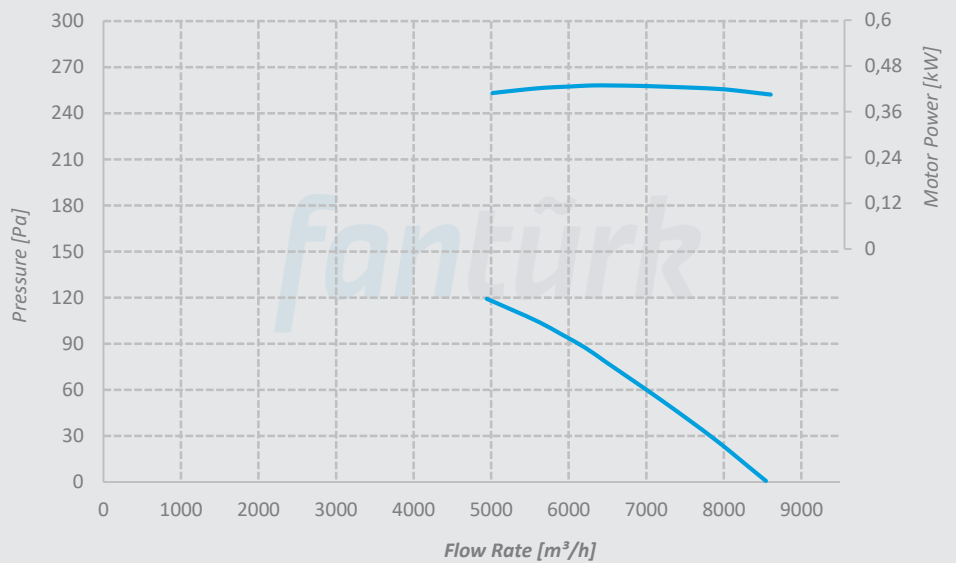

**P-FWA 500**  
**Y-FWA 500**  
**H-FWA 500**  
**Ç-FWA 500**

Nos. of Blades 6  
 Hub Size 6  
 Pitch Angle 45°  
 Nos. of Poles 6  
 Material Aluminum

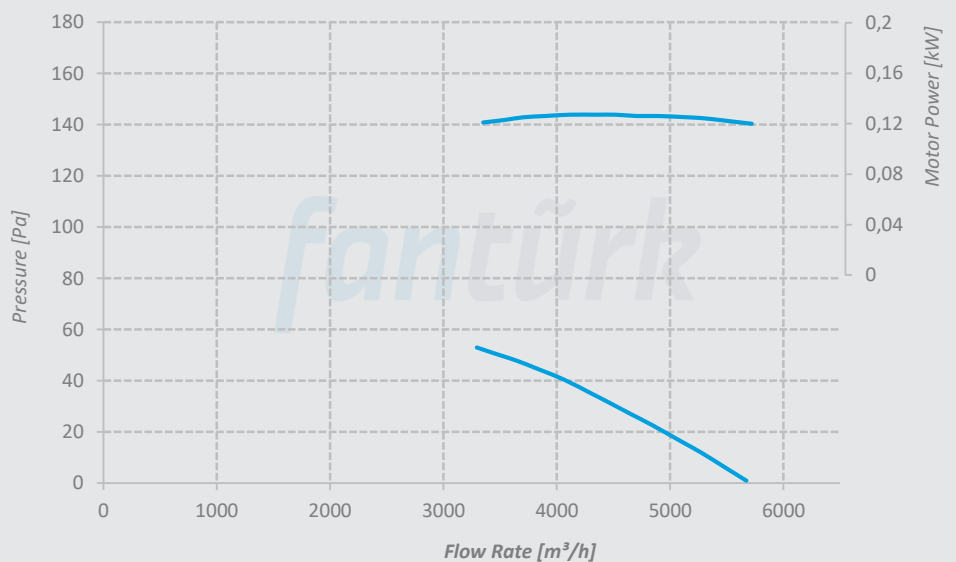

# Performance Curves

**P-FWA 500**  
**Y-FWA 500**  
**H-FWA 500**  
**Ç-FWA 500**

Nos. of Blades 5  
 Hub Size 5  
 Nos. of Poles 2  
 Material Aluminum  
 Pitch Angle

- 25°    — 30°    — 32,5°
- 35°    — 37,5°    — 40°
- 45°    — 50°

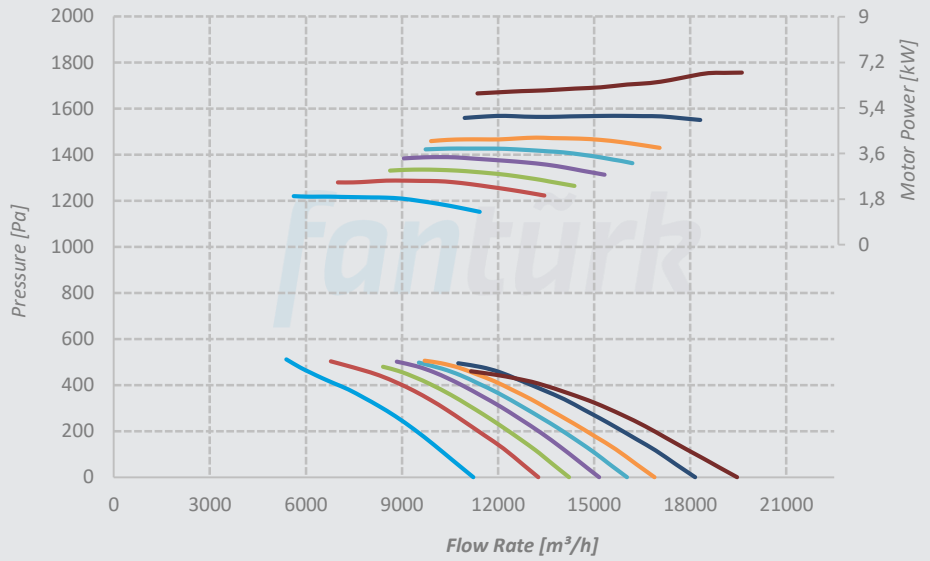

**P-FWA 500**  
**Y-FWA 500**  
**H-FWA 500**  
**Ç-FWA 500**

Nos. of Blades 5  
 Hub Size 5  
 Nos. of Poles 4  
 Material Aluminum  
 Pitch Angle

- 25°    — 30°    — 32,5°
- 35°    — 37,5°    — 40°
- 45°    — 50°

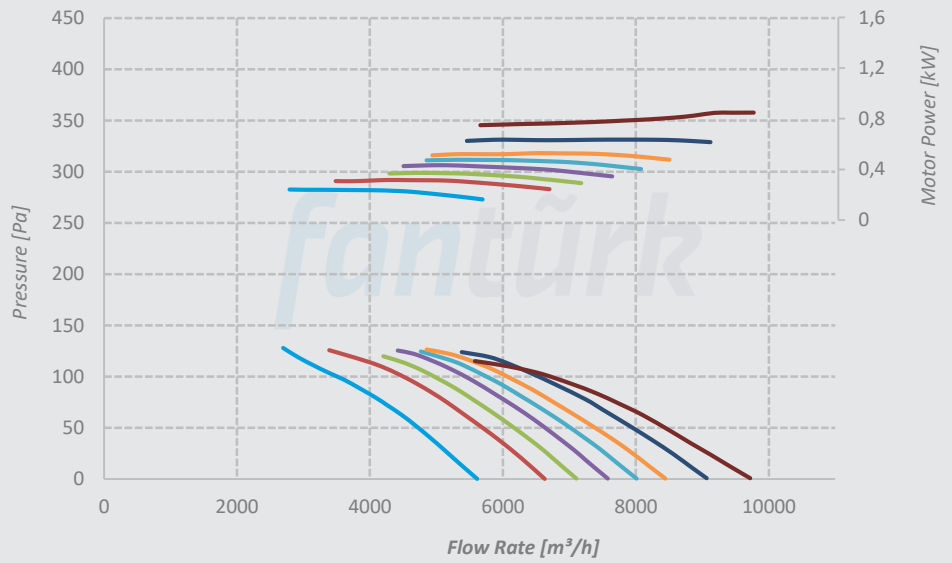

**P-FWA 500**  
**Y-FWA 500**  
**H-FWA 500**  
**Ç-FWA 500**

Nos. of Blades 5  
 Hub Size 5  
 Nos. of Poles 6  
 Material Aluminum  
 Pitch Angle

- 25°    — 30°    — 32,5°
- 35°    — 37,5°    — 40°
- 45°    — 50°

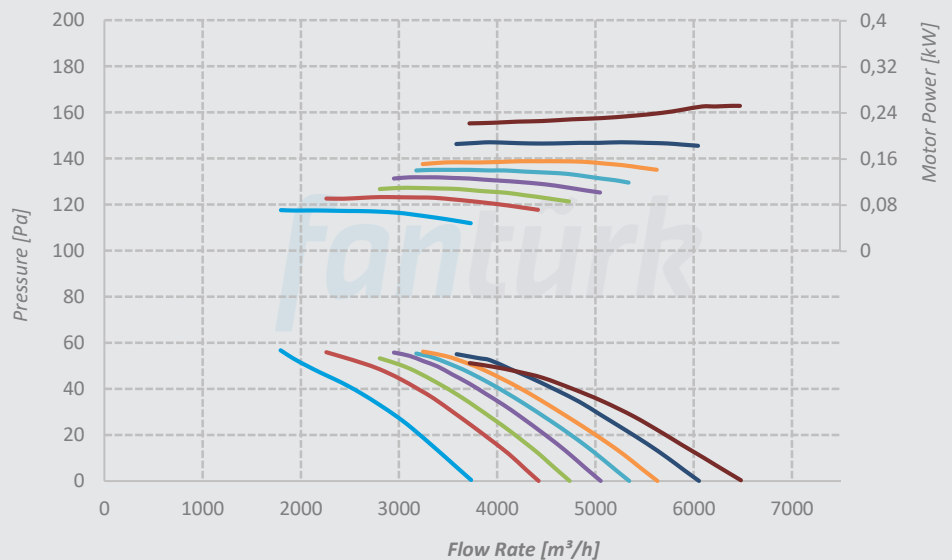

## Performance Curves

**P-FWA 560**  
**Y-FWA 560**  
**H-FWA 560**  
**Ç-FWA 560**

Nos. of Blades 3  
 Hub Size 6  
 Pitch Angle 45°  
 Nos. of Poles 2  
 Material Aluminum

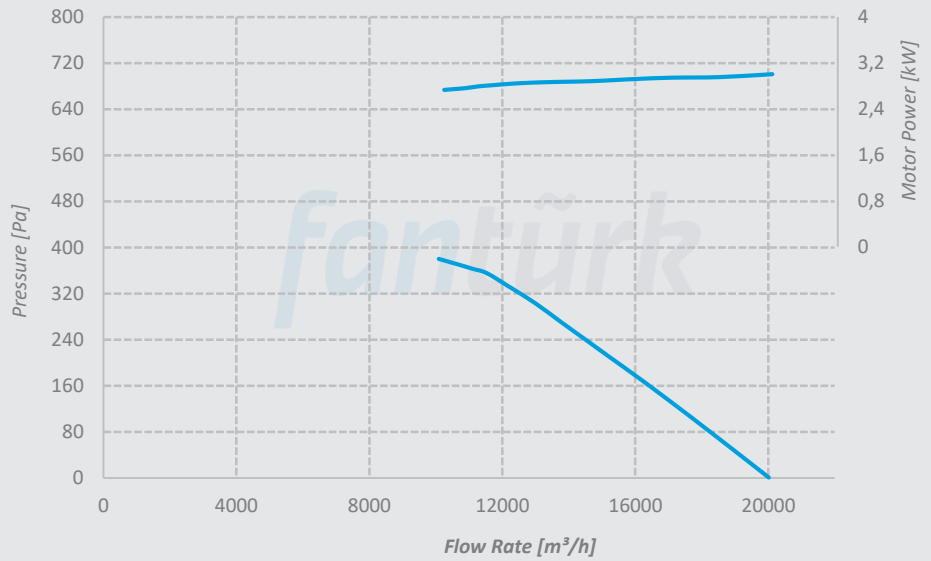

**P-FWA 560**  
**Y-FWA 560**  
**H-FWA 560**  
**Ç-FWA 560**

Nos. of Blades 3  
 Hub Size 6  
 Pitch Angle 45°  
 Nos. of Poles 4  
 Material Aluminum

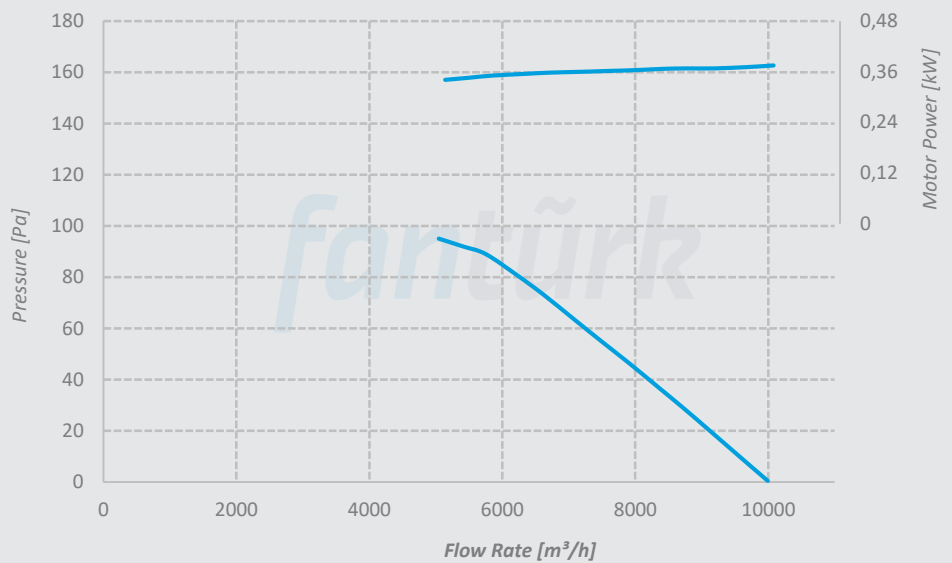

**P-FWA 560**  
**Y-FWA 560**  
**H-FWA 560**  
**Ç-FWA 560**

Nos. of Blades 3  
 Hub Size 6  
 Pitch Angle 45°  
 Nos. of Poles 6  
 Material Aluminum

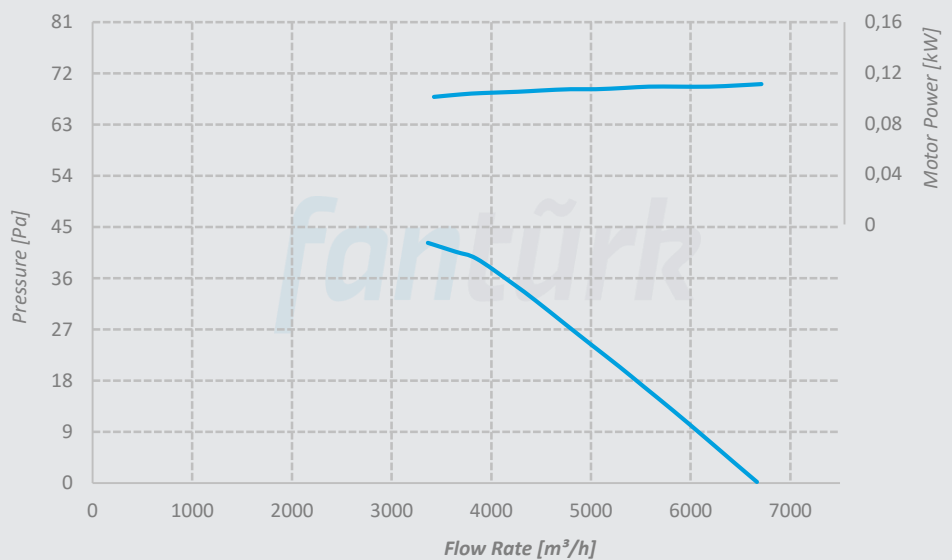

## Performance Curves

**P-FWA 560**  
**Y-FWA 560**  
**H-FWA 560**  
**Ç-FWA 560**

Nos. of Blades 6  
 Hub Size 6  
 Pitch Angle 45°  
 Nos. of Poles 2  
 Material Aluminum

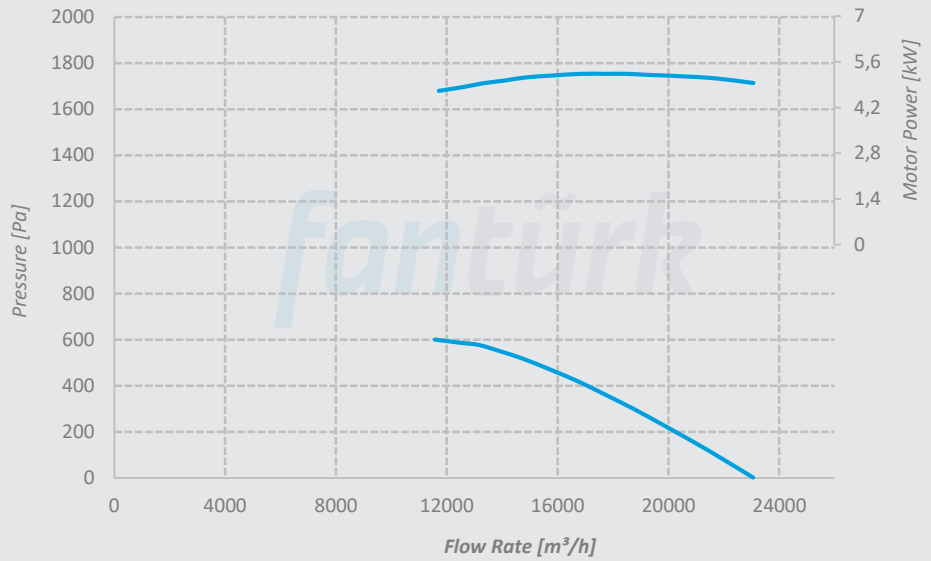

**P-FWA 560**  
**Y-FWA 560**  
**H-FWA 560**  
**Ç-FWA 560**

Nos. of Blades 6  
 Hub Size 6  
 Pitch Angle 45°  
 Nos. of Poles 4  
 Material Aluminum

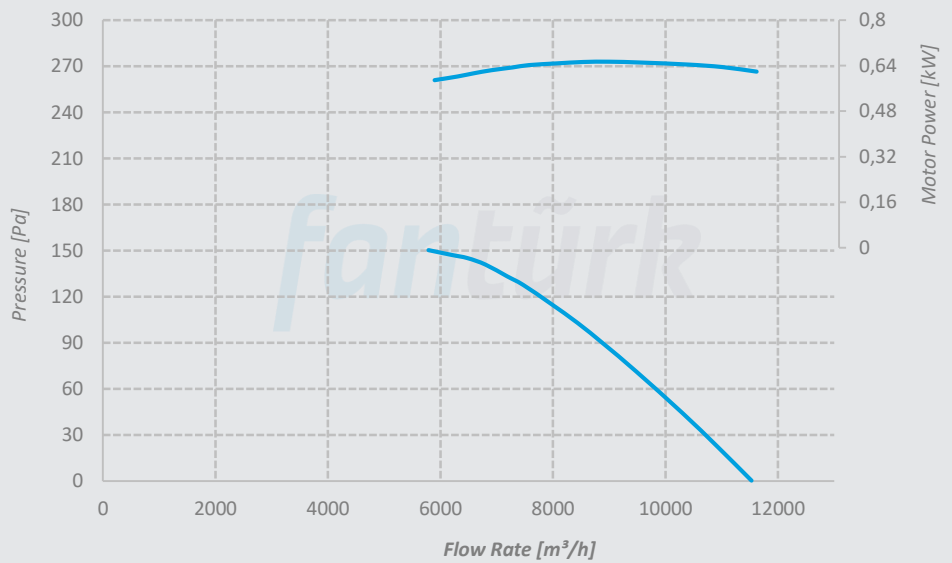

**P-FWA 560**  
**Y-FWA 560**  
**H-FWA 560**  
**Ç-FWA 560**

Nos. of Blades 6  
 Hub Size 6  
 Pitch Angle 45°  
 Nos. of Poles 6  
 Material Aluminum

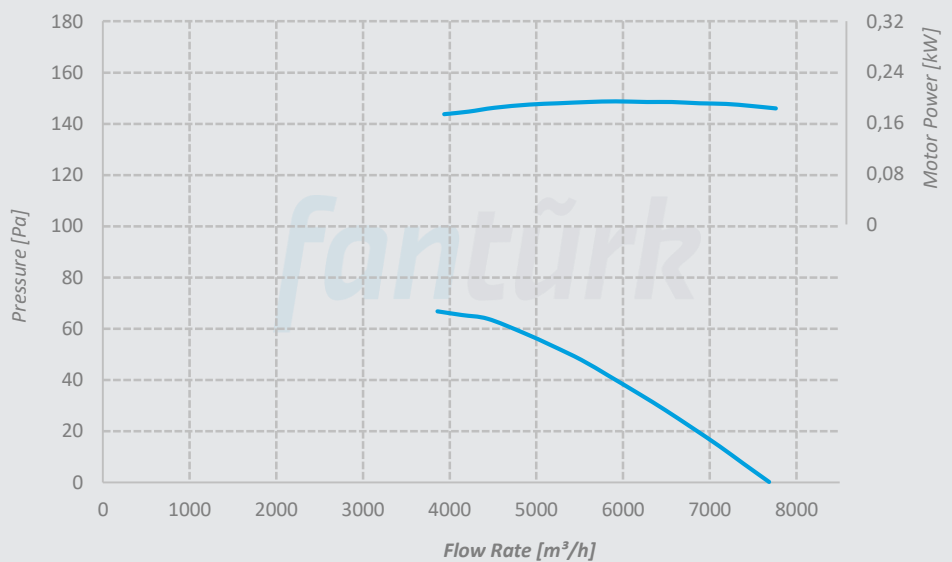

# Performance Curves

**P-FWA 560**  
**Y-FWA 560**  
**H-FWA 560**  
**Ç-FWA 560**

Nos. of Blades 5  
 Hub Size 5  
 Nos. of Poles 2  
 Material Aluminum  
 Pitch Angle

25° 30° 32,5°  
 35° 37,5° 40°  
 45° 50°

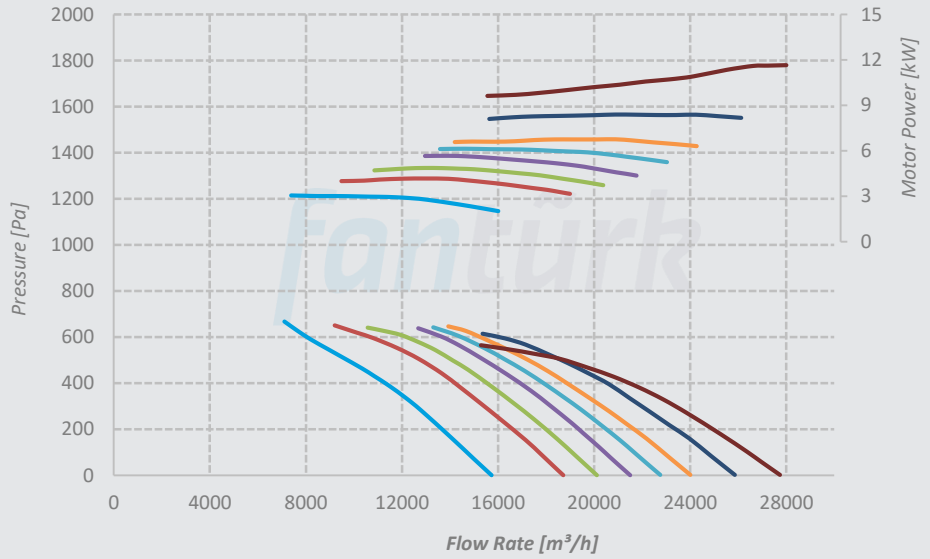

**P-FWA 560**  
**Y-FWA 560**  
**H-FWA 560**  
**Ç-FWA 560**

Nos. of Blades 5  
 Hub Size 5  
 Nos. of Poles 4  
 Material Aluminum  
 Pitch Angle

25° 30° 32,5°  
 35° 37,5° 40°  
 45° 50°

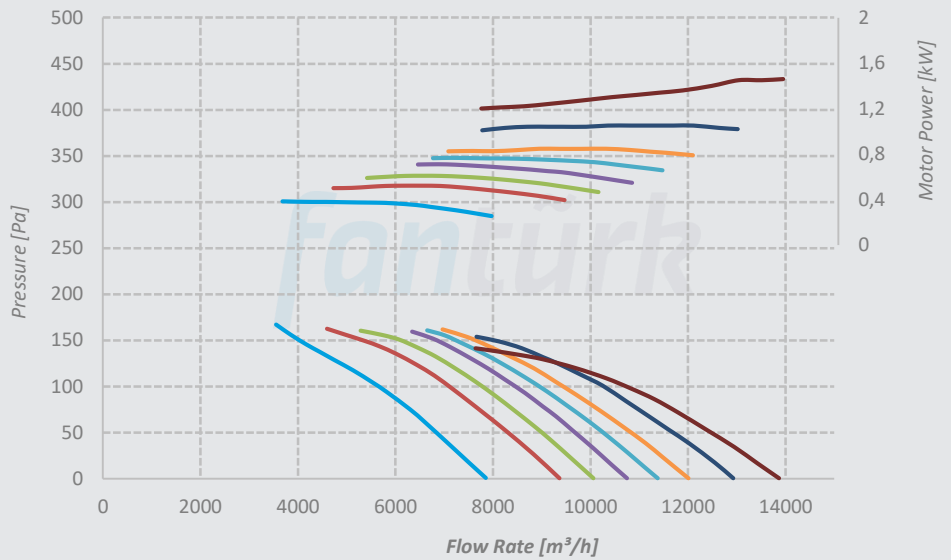

**P-FWA 560**  
**Y-FWA 560**  
**H-FWA 560**  
**Ç-FWA 560**

Nos. of Blades 5  
 Hub Size 5  
 Nos. of Poles 6  
 Material Aluminum  
 Pitch Angle

25° 30° 32,5°  
 35° 37,5° 40°  
 45° 50°

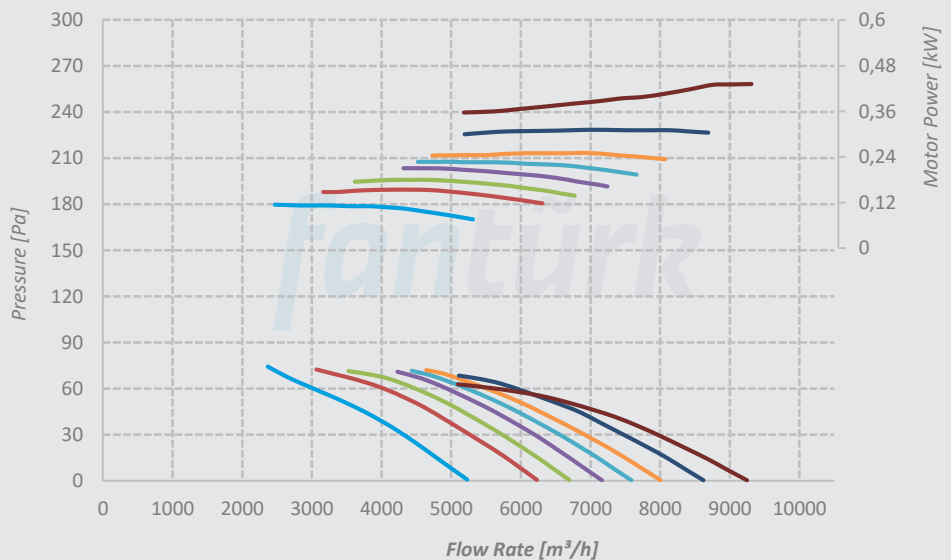

# Performance Curves

**P-FWA 630**  
**Y-FWA 630**  
**H-FWA 630**  
**Ç-FWA 630**

Nos. of Blades 5  
 Hub Size 5  
 Nos. of Poles 2  
 Material Aluminum  
 Pitch Angle

25° 30° 32,5°  
 35° 37,5° 40°  
 45°

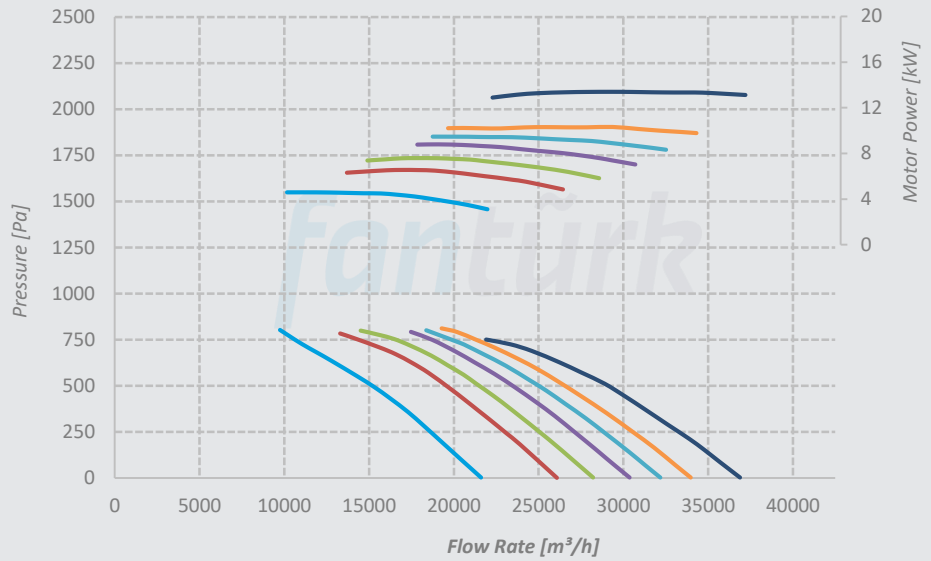

**P-FWA 630**  
**Y-FWA 630**  
**H-FWA 630**  
**Ç-FWA 630**

Nos. of Blades 5  
 Hub Size 5  
 Nos. of Poles 4  
 Material Aluminum  
 Pitch Angle

25° 30° 32,5°  
 35° 37,5° 40°  
 45° 50°

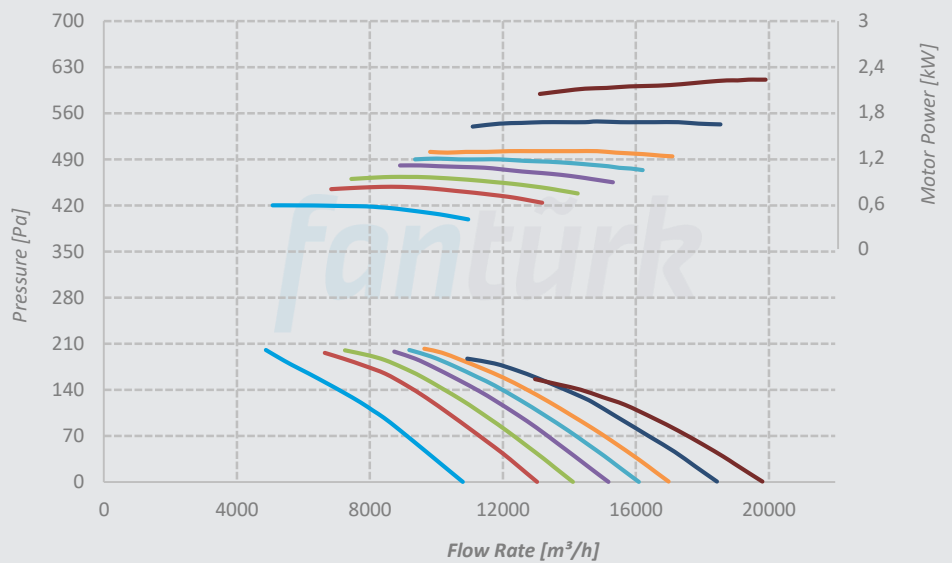

**P-FWA 630**  
**Y-FWA 630**  
**H-FWA 630**  
**Ç-FWA 630**

Nos. of Blades 5  
 Hub Size 5  
 Nos. of Poles 6  
 Material Aluminum  
 Pitch Angle

25° 30° 32,5°  
 35° 37,5° 40°  
 45° 50°

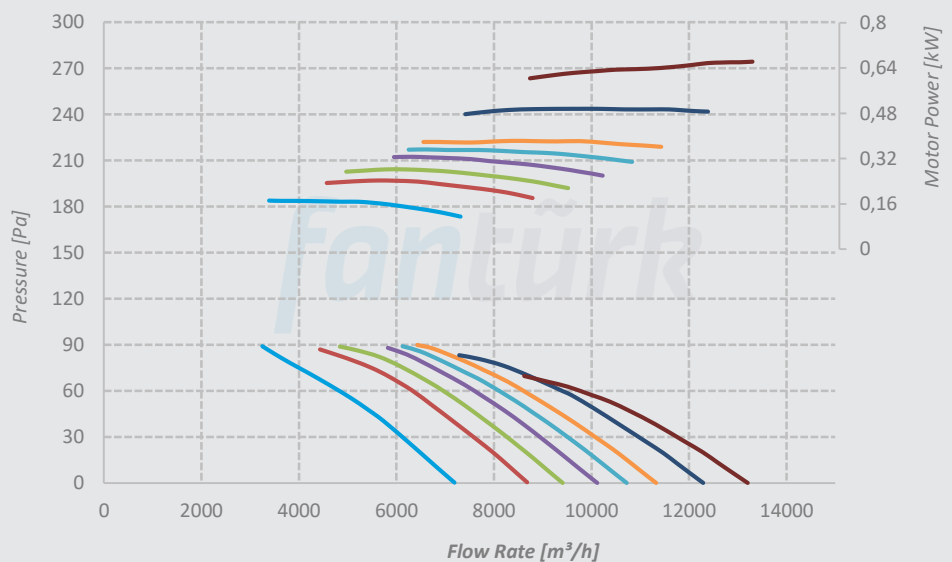



# Performance Curves

**P-FWA 630**  
**Y-FWA 630**  
**H-FWA 630**  
**Ç-FWA 630**

Nos. of Blades 8  
 Hub Size 8  
 Nos. of Poles 2  
 Material Aluminum  
 Pitch Angle

— 25° — 30°  
 — 32,5° — 35°

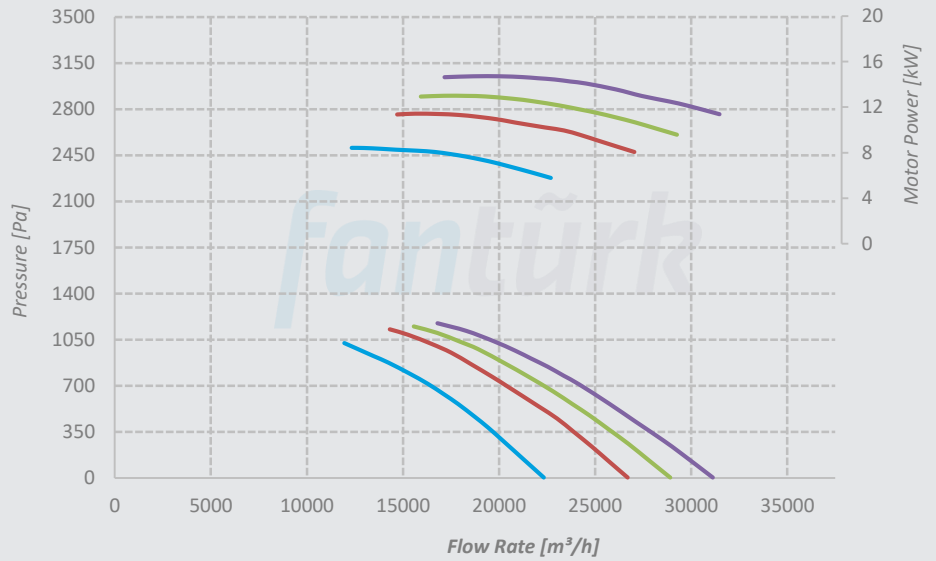

**P-FWA 630**  
**Y-FWA 630**  
**H-FWA 630**  
**Ç-FWA 630**

Nos. of Blades 8  
 Hub Size 8  
 Nos. of Poles 4  
 Material Aluminum  
 Pitch Angle

— 25° — 30° — 32,5°  
 — 35° — 37,5° — 40°  
 — 45° — 50°

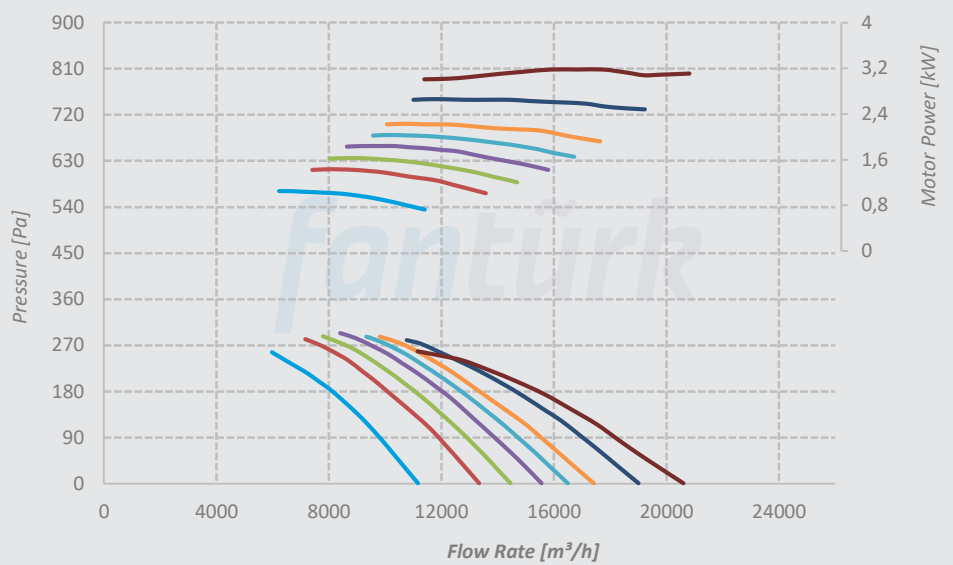

**P-FWA 630**  
**Y-FWA 630**  
**H-FWA 630**  
**Ç-FWA 630**

Nos. of Blades 8  
 Hub Size 8  
 Nos. of Poles 6  
 Material Aluminum  
 Pitch Angle

— 25° — 30° — 32,5°  
 — 35° — 37,5° — 40°  
 — 45° — 50°

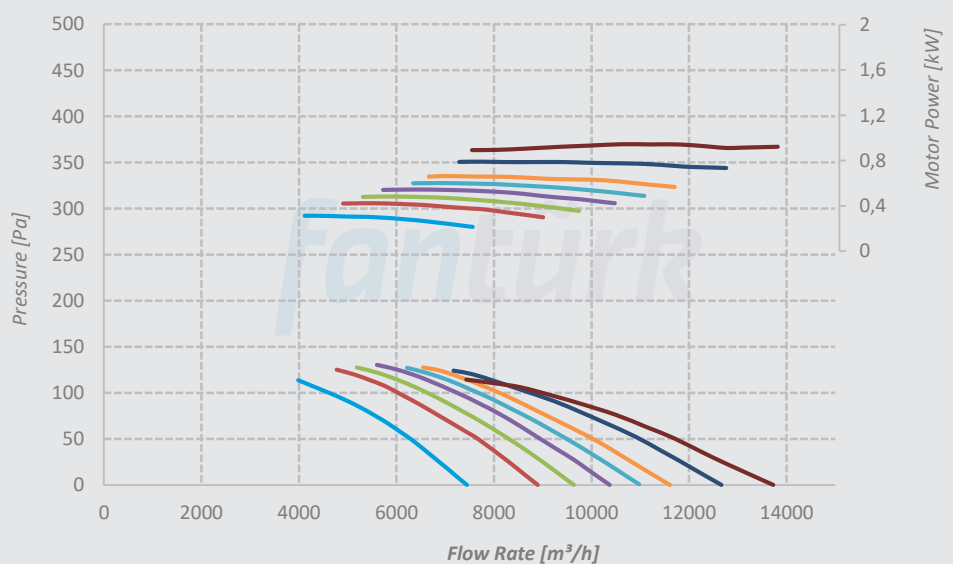

# Performance Curves

## P-FWA 710 Y-FWA 710 H-FWA 710 Ç-FWA 710

Nos. of Blades 5  
Hub Size 5  
Nos. of Poles 4  
Material Aluminum  
Pitch Angle

- 25°    — 30°    — 32,5°
- 35°    — 37,5°    — 40°
- 45°    — 50°

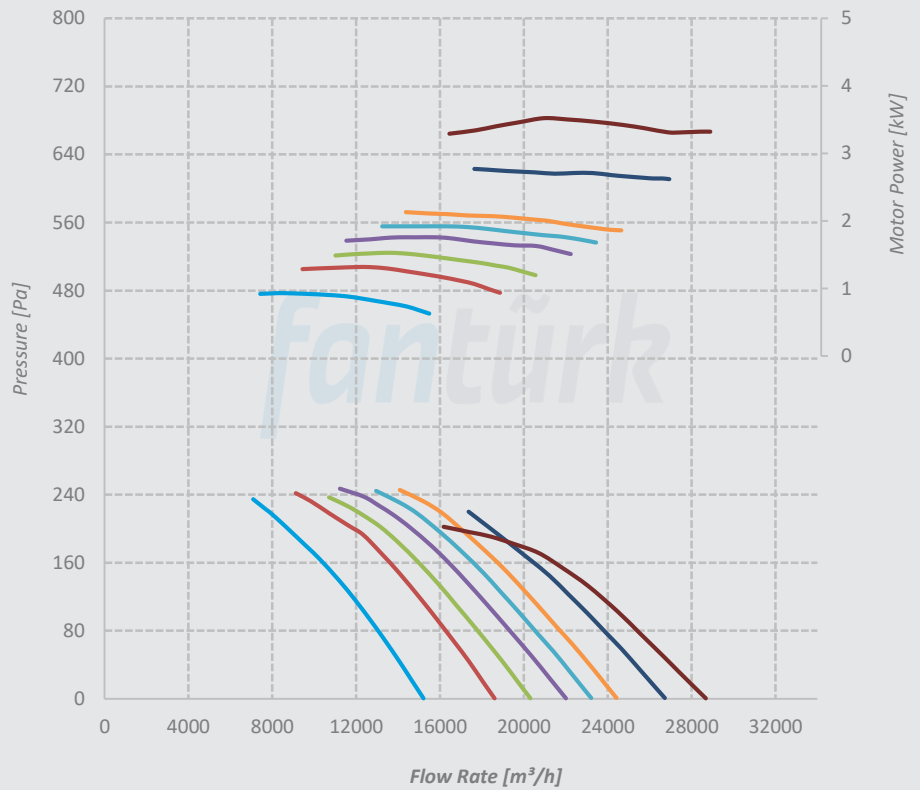

## P-FWA 710 Y-FWA 710 H-FWA 710 Ç-FWA 710

Nos. of Blades 5  
Hub Size 5  
Nos. of Poles 6  
Material Aluminum  
Pitch Angle

- 25°    — 30°    — 32,5°
- 35°    — 37,5°    — 40°
- 45°    — 50°

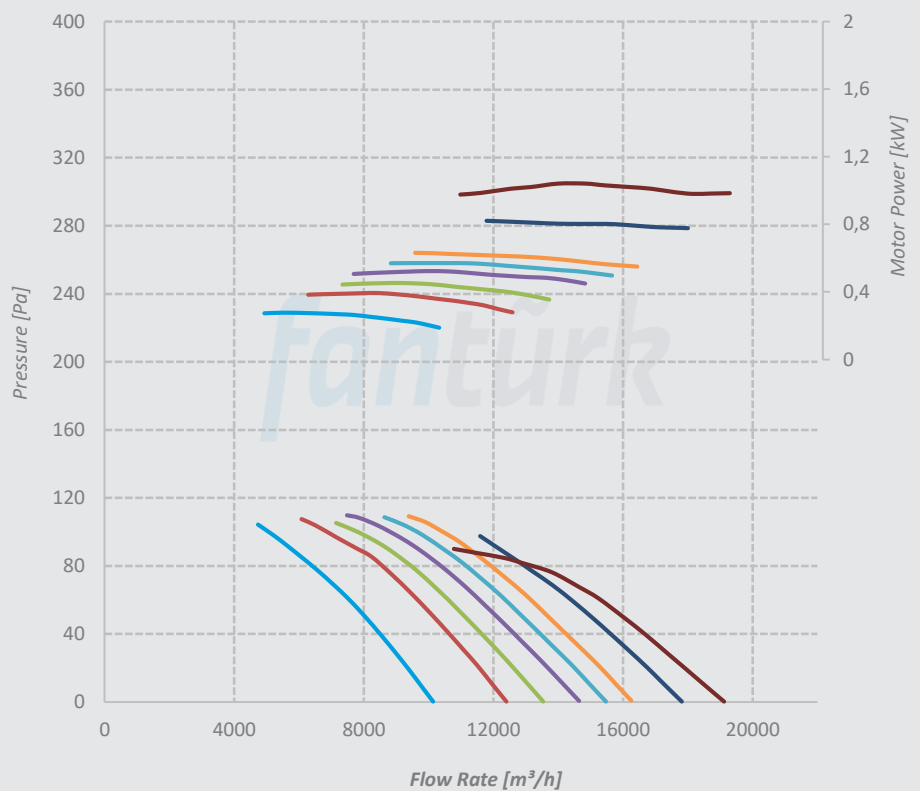

## Performance Curves

### P-FWA 710 Y-FWA 710 H-FWA 710 Ç-FWA 710

Nos. of Blades 8  
Hub Size 8  
Nos. of Poles 4  
Material Aluminum  
Pitch Angle

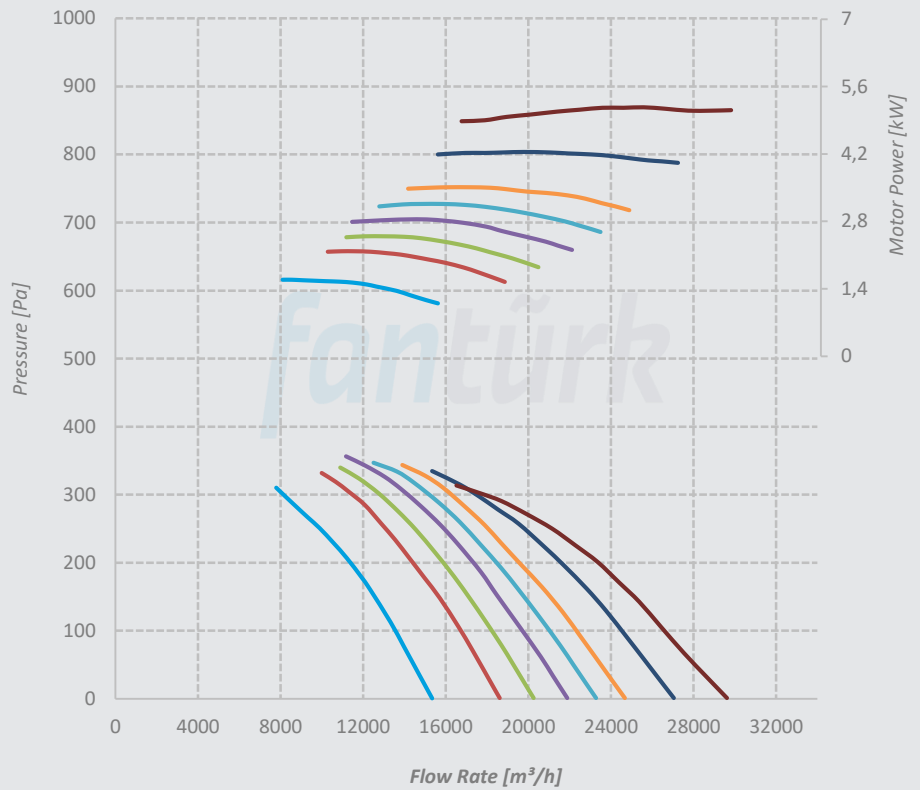
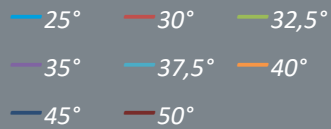

### P-FWA 710 Y-FWA 710 H-FWA 710 Ç-FWA 710

Nos. of Blades 8  
Hub Size 8  
Nos. of Poles 6  
Material Aluminum  
Pitch Angle

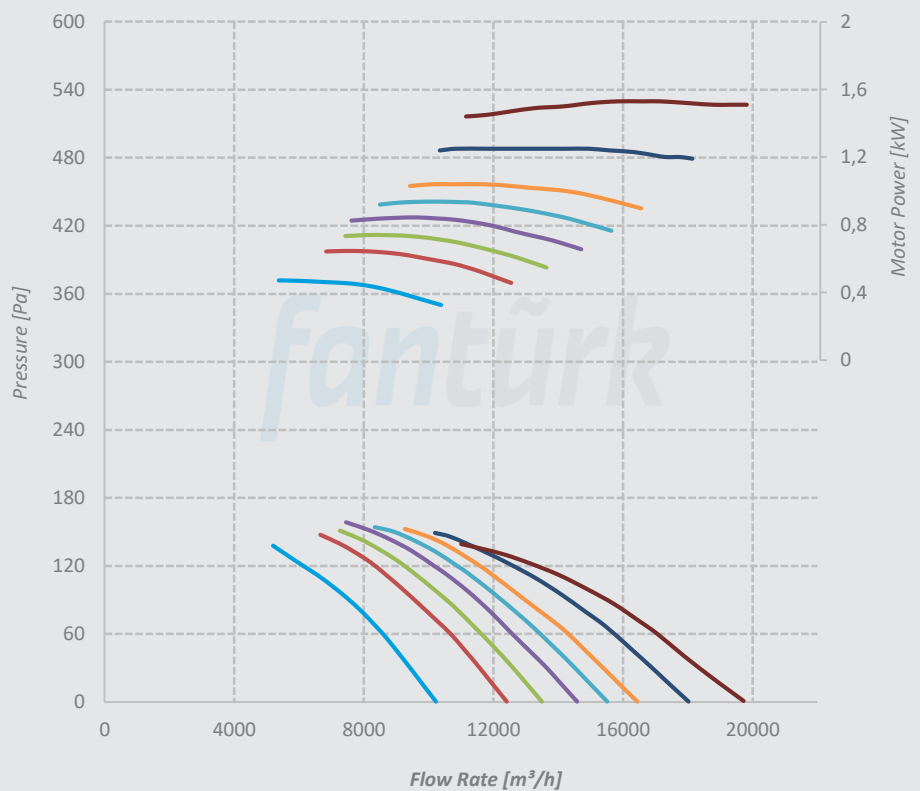
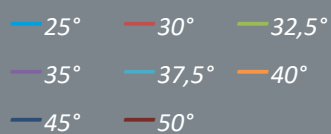

# Performance Curves

**P-FWA 800**  
**Y-FWA 800**  
**H-FWA 800**  
**Ç-FWA 800**

Nos. of Blades 5  
 Hub Size 5  
 Nos. of Poles 4  
 Material Aluminum  
 Pitch Angle

- 25°    — 30°    — 32,5°
- 35°    — 37,5°    — 40°
- 45°    — 50°

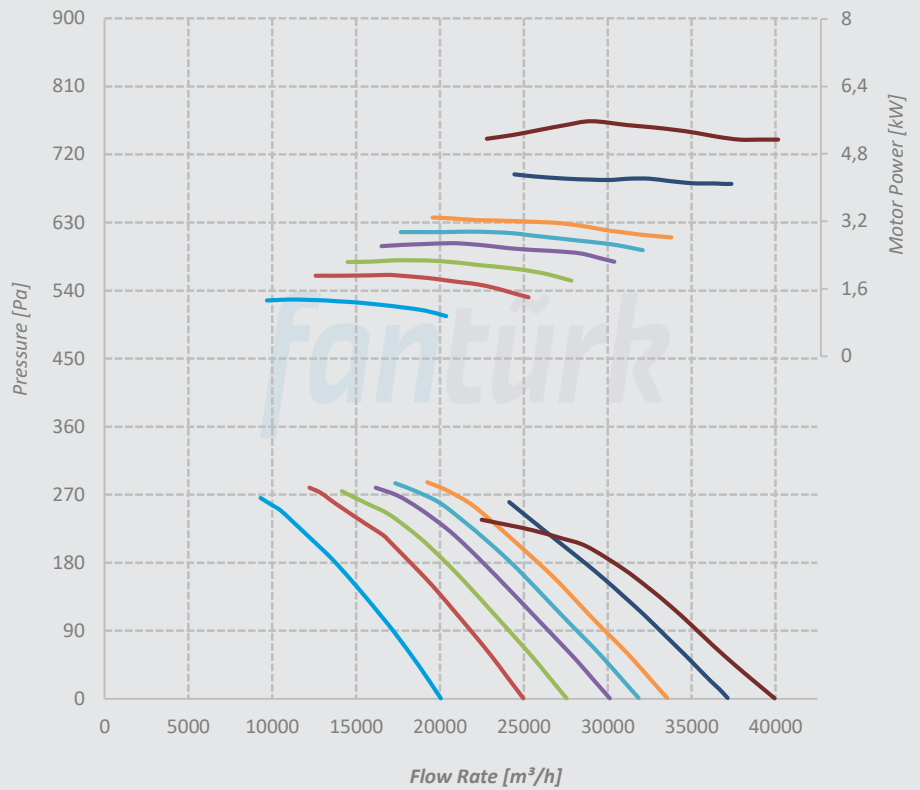

**P-FWA 800**  
**Y-FWA 800**  
**H-FWA 800**  
**Ç-FWA 800**

Nos. of Blades 5  
 Hub Size 5  
 Nos. of Poles 6  
 Material Aluminum  
 Pitch Angle

- 25°    — 30°    — 32,5°
- 35°    — 37,5°    — 40°
- 45°    — 50°

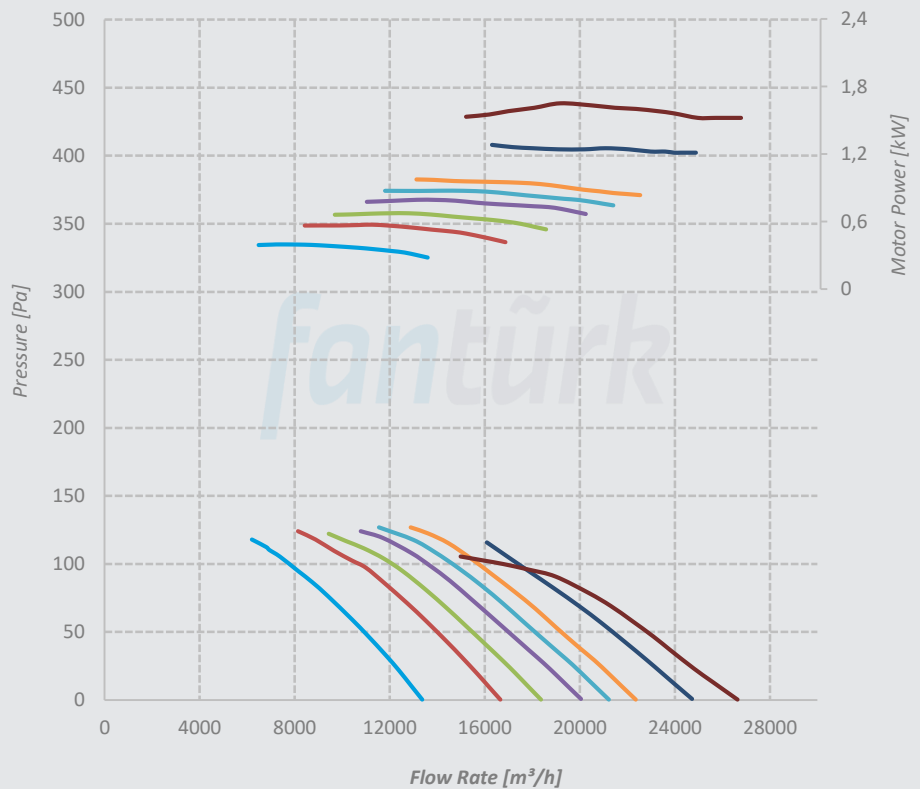

# Performance Curves

## P-FWA 800 Y-FWA 800 H-FWA 800 Ç-FWA 800

Nos. of Blades 8  
Hub Size 8  
Nos. of Poles 4  
Material Aluminum  
Pitch Angle

- 25°    — 30°    — 32,5°
- 35°    — 37,5°    — 40°
- 45°    — 50°

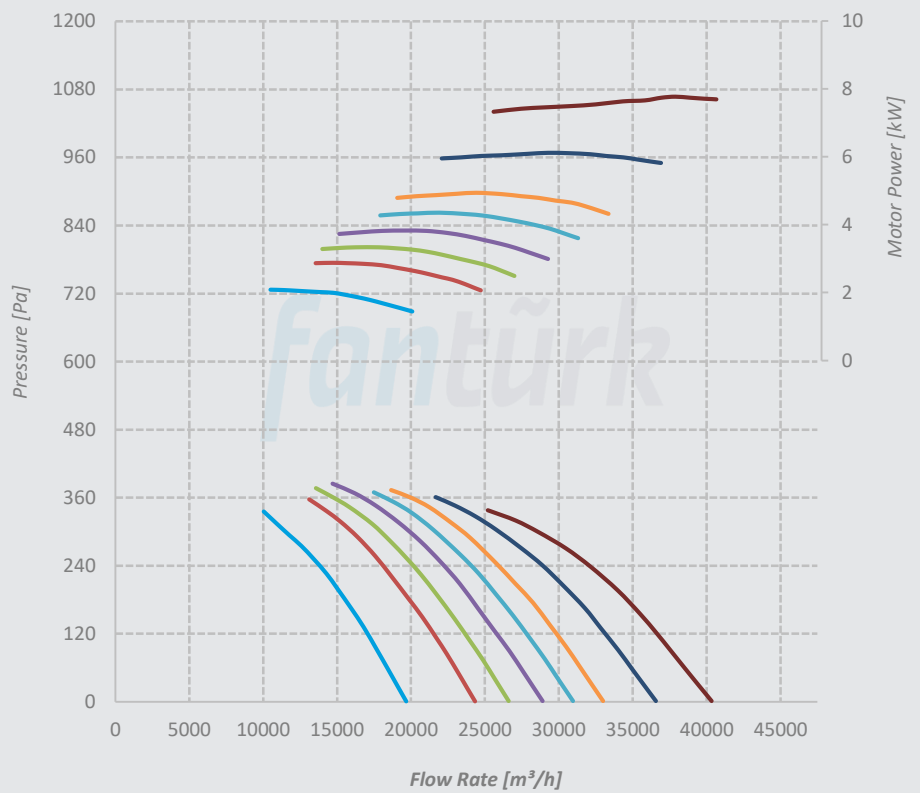

## P-FWA 800 Y-FWA 800 H-FWA 800 Ç-FWA 800

Nos. of Blades 8  
Hub Size 8  
Nos. of Poles 6  
Material Aluminum  
Pitch Angle

- 25°    — 30°    — 32,5°
- 35°    — 37,5°    — 40°
- 45°    — 50°

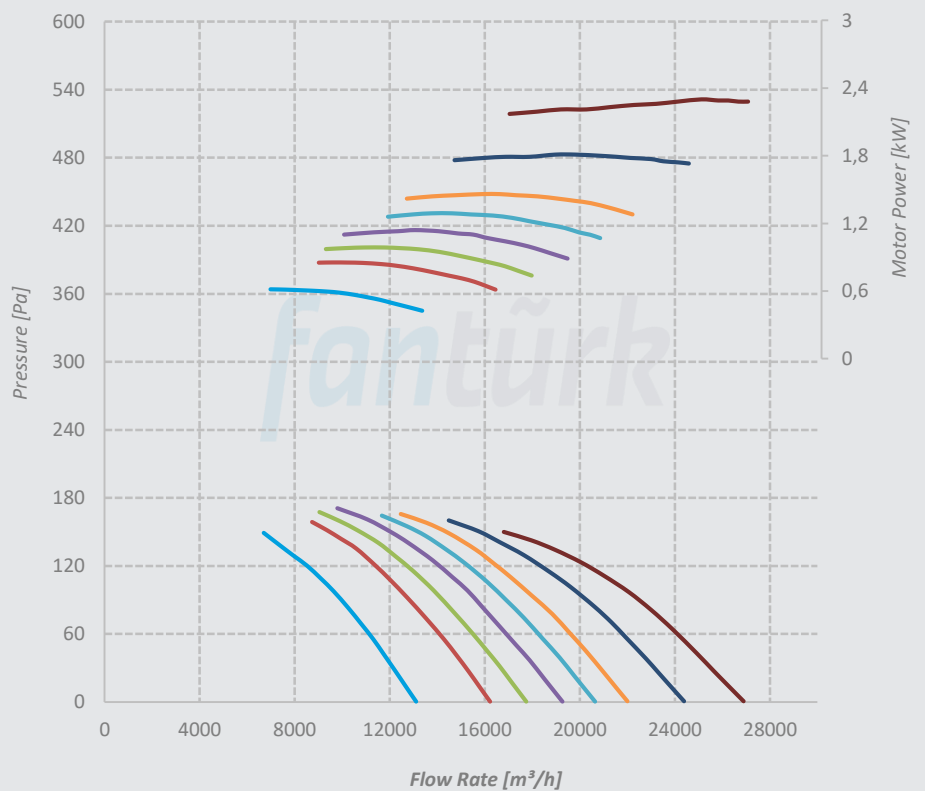

# Performance Curves

**P-FWA 900**  
**Y-FWA 900**  
**H-FWA 900**  
**Ç-FWA 900**

Nos. of Blades 5  
 Hub Size 5  
 Nos. of Poles 4  
 Material Aluminum  
 Pitch Angle

- 25°    — 30°    — 32,5°
- 35°    — 37,5°    — 40°
- 45°    — 50°

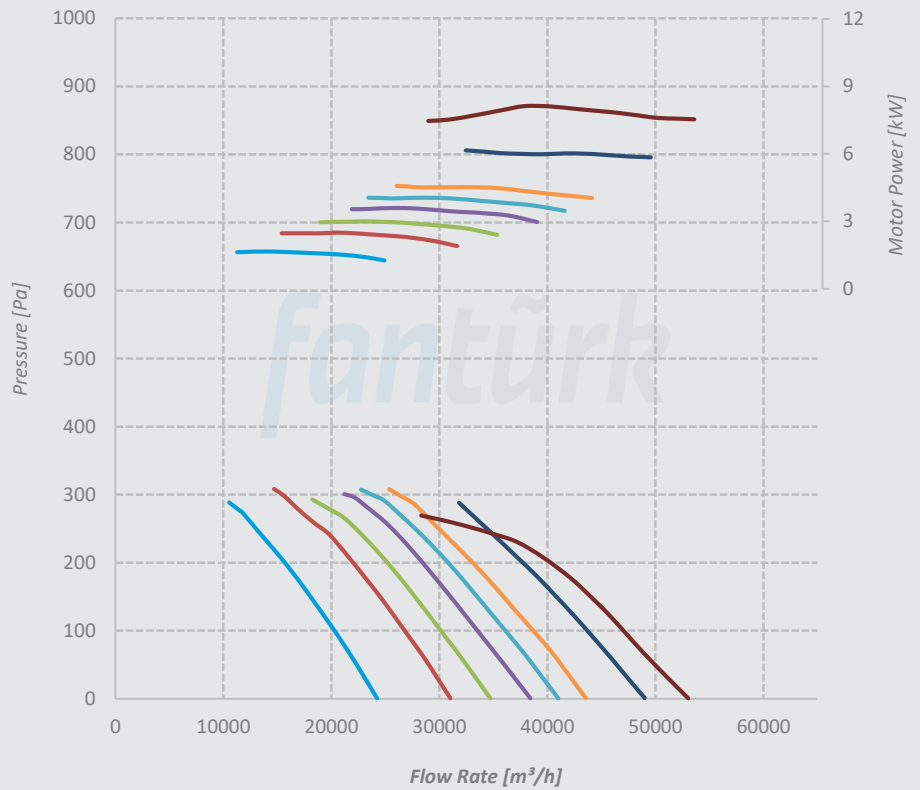

**P-FWA 900**  
**Y-FWA 900**  
**H-FWA 900**  
**Ç-FWA 900**

Nos. of Blades 5  
 Hub Size 5  
 Nos. of Poles 6  
 Material Aluminum  
 Pitch Angle

- 25°    — 30°    — 32,5°
- 35°    — 37,5°    — 40°
- 45°    — 50°

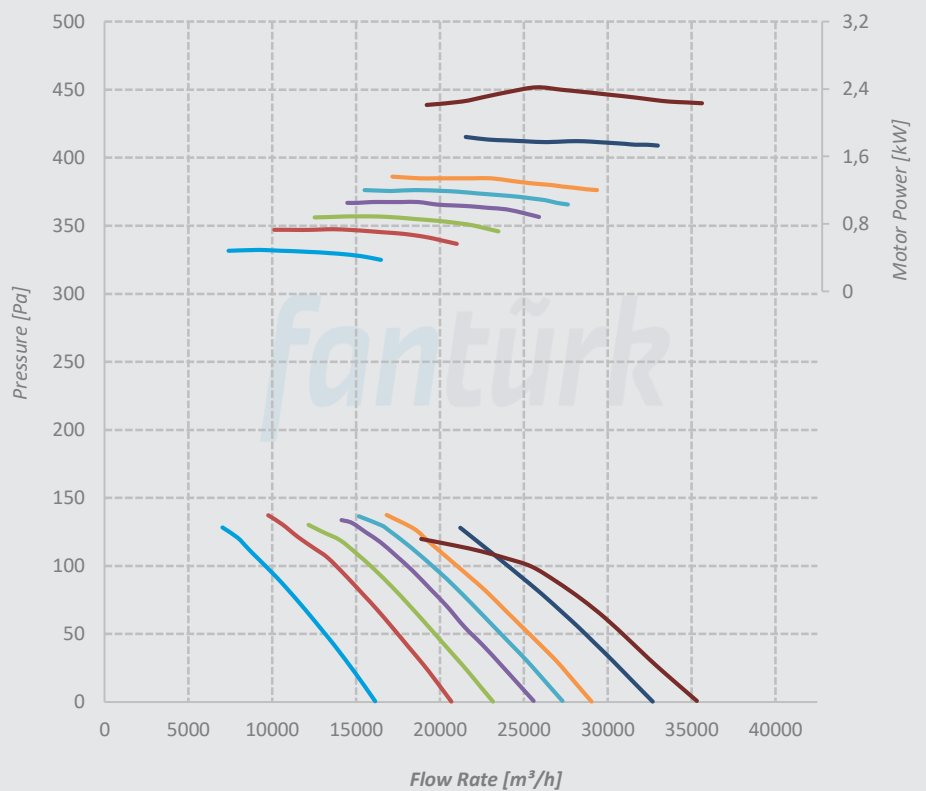

# Performance Curves

**P-FWA 900**  
**Y-FWA 900**  
**H-FWA 900**  
**Ç-FWA 900**

Nos. of Blades 8  
 Hub Size 8  
 Nos. of Poles 4  
 Material Aluminum  
 Pitch Angle

- 25°    — 30°    — 32,5°
- 35°    — 37,5°    — 40°
- 45°    — 50°

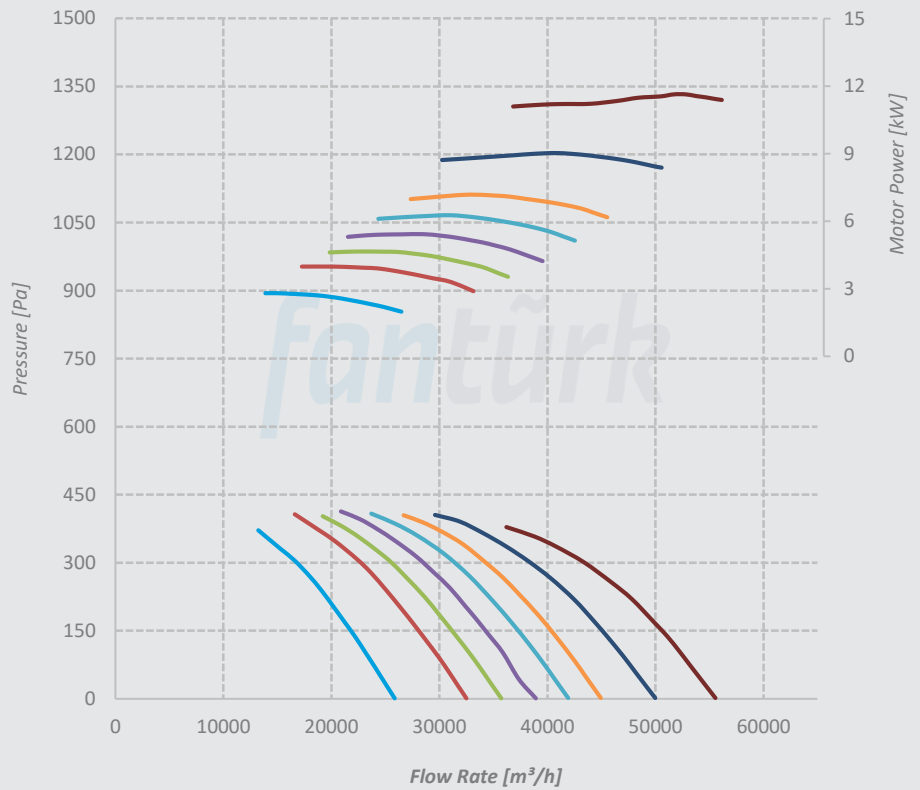

**P-FWA 900**  
**Y-FWA 900**  
**H-FWA 900**  
**Ç-FWA 900**

Nos. of Blades 8  
 Hub Size 8  
 Nos. of Poles 6  
 Material Aluminum  
 Pitch Angle

- 25°    — 30°    — 32,5°
- 35°    — 37,5°    — 40°
- 45°    — 50°

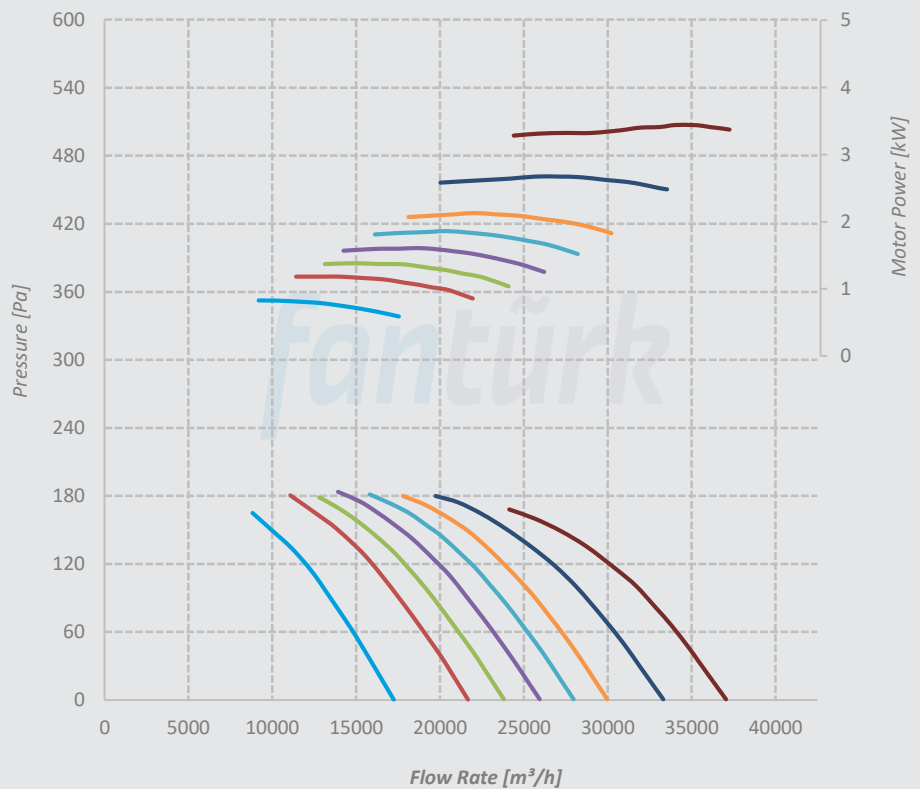

# Performance Curves

**P-FWA 1000**  
**Y-FWA 1000**  
**H-FWA 1000**  
**Ç-FWA 1000**

Nos. of Blades 5  
 Hub Size 5  
 Nos. of Poles 4  
 Material Aluminum  
 Pitch Angle

- 25°    — 30°    — 32,5°
- 35°    — 37,5°    — 40°
- 45°    — 50°

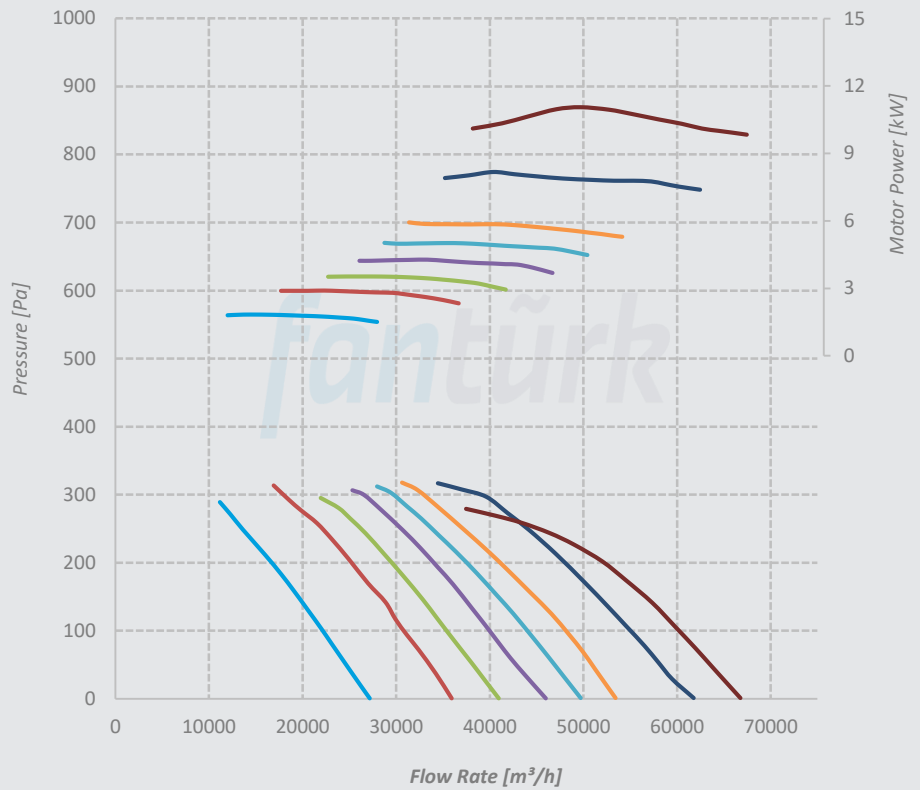

**P-FWA 1000**  
**Y-FWA 1000**  
**H-FWA 1000**  
**Ç-FWA 1000**

Nos. of Blades 5  
 Hub Size 5  
 Nos. of Poles 6  
 Material Aluminum  
 Pitch Angle

- 25°    — 30°    — 32,5°
- 35°    — 37,5°    — 40°
- 45°    — 50°

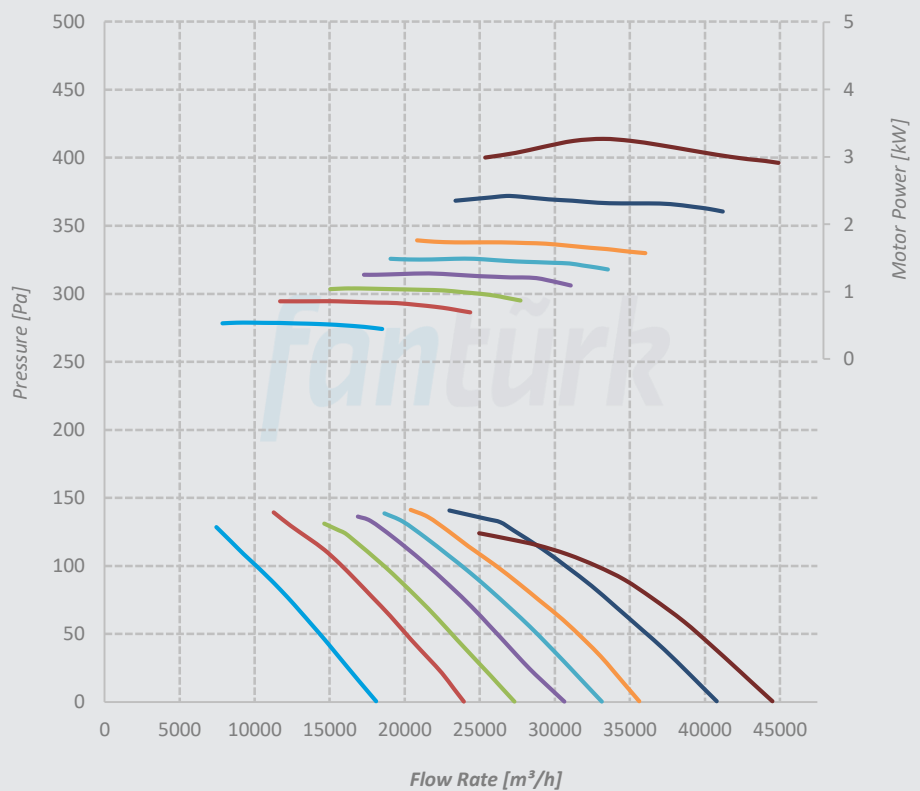



# Performance Curves

**P-FWA 1000**  
**Y-FWA 1000**  
**H-FWA 1000**  
**Ç-FWA 1000**

Nos. of Blades 8  
 Hub Size 8  
 Nos. of Poles 4  
 Material Aluminum  
 Pitch Angle

- 25°    — 30°    — 32,5°
- 35°    — 37,5°    — 40°
- 45°    — 50°

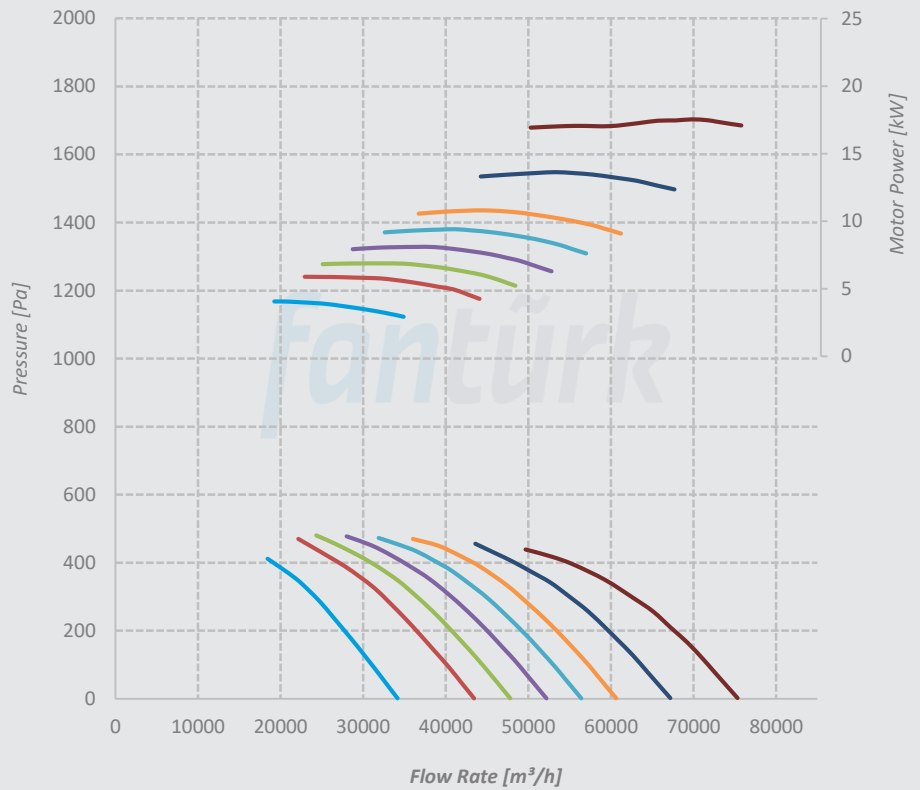

**P-FWA 1000**  
**Y-FWA 1000**  
**H-FWA 1000**  
**Ç-FWA 1000**

Nos. of Blades 8  
 Hub Size 8  
 Nos. of Poles 6  
 Material Aluminum  
 Pitch Angle

- 25°    — 30°    — 32,5°
- 35°    — 37,5°    — 40°
- 45°    — 50°

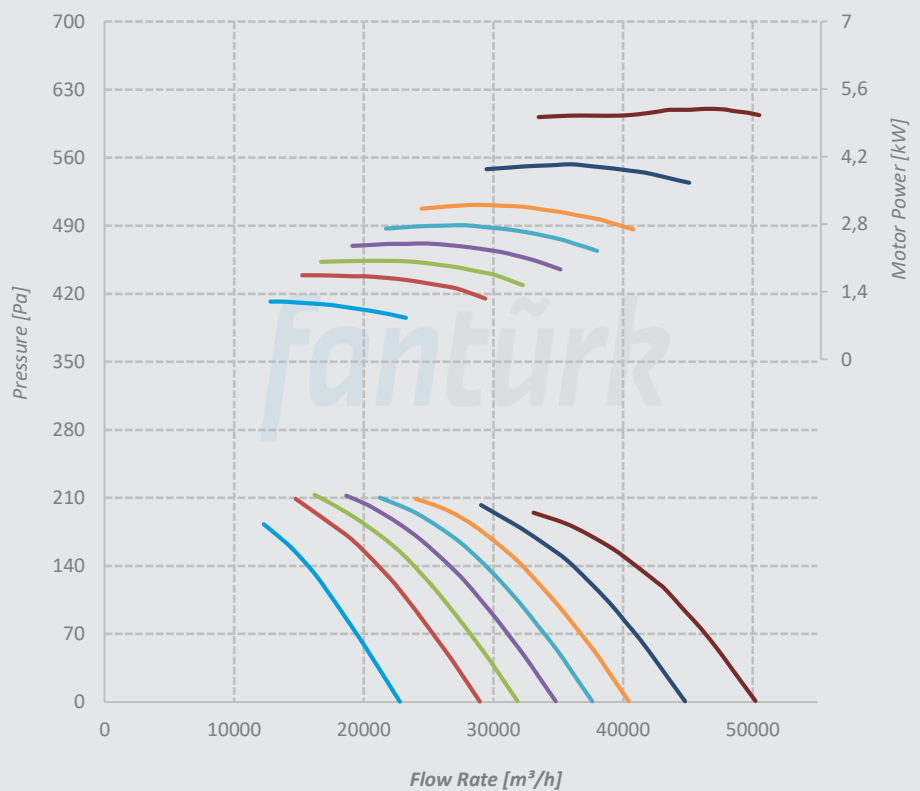

# Performance Curves

## P-FWA 1120 Y-FWA 1120 H-FWA 1120 Ç-FWA 1120

Nos. of Blades 8  
Hub Size 8  
Nos. of Poles 4  
Material Aluminum  
Pitch Angle

- 25°    — 30°    — 32,5°
- 35°    — 37,5°    — 40°
- 45°    — 50°

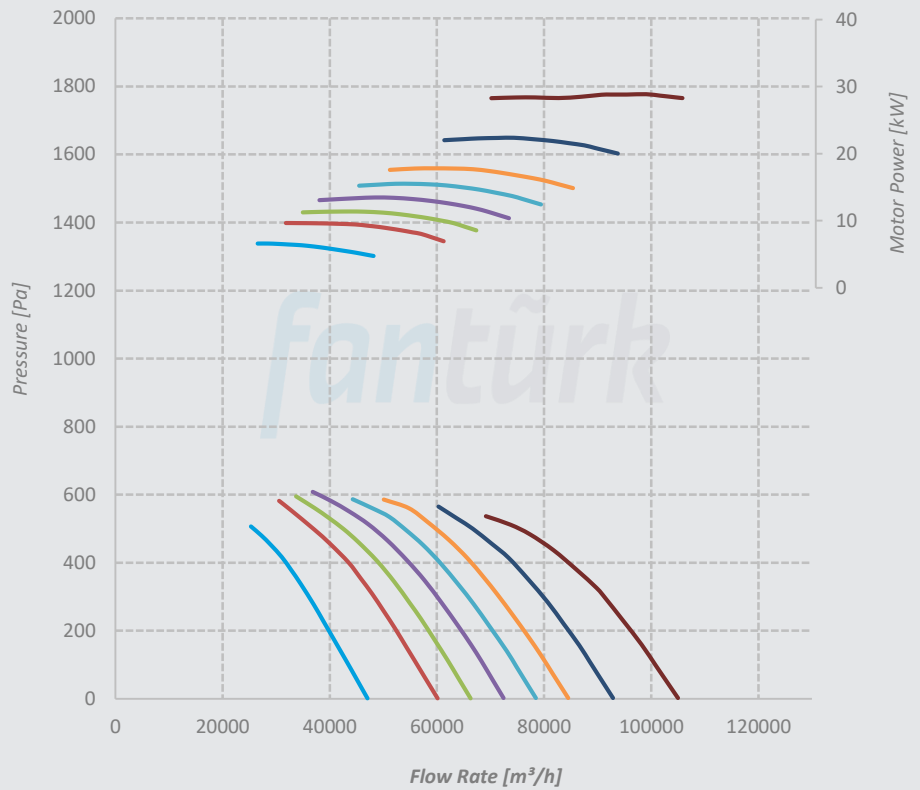

## P-FWA 1120 Y-FWA 1120 H-FWA 1120 Ç-FWA 1120

Nos. of Blades 8  
Hub Size 8  
Nos. of Poles 6  
Material Aluminum  
Pitch Angle

- 25°    — 30°    — 32,5°
- 35°    — 37,5°    — 40°
- 45°    — 50°

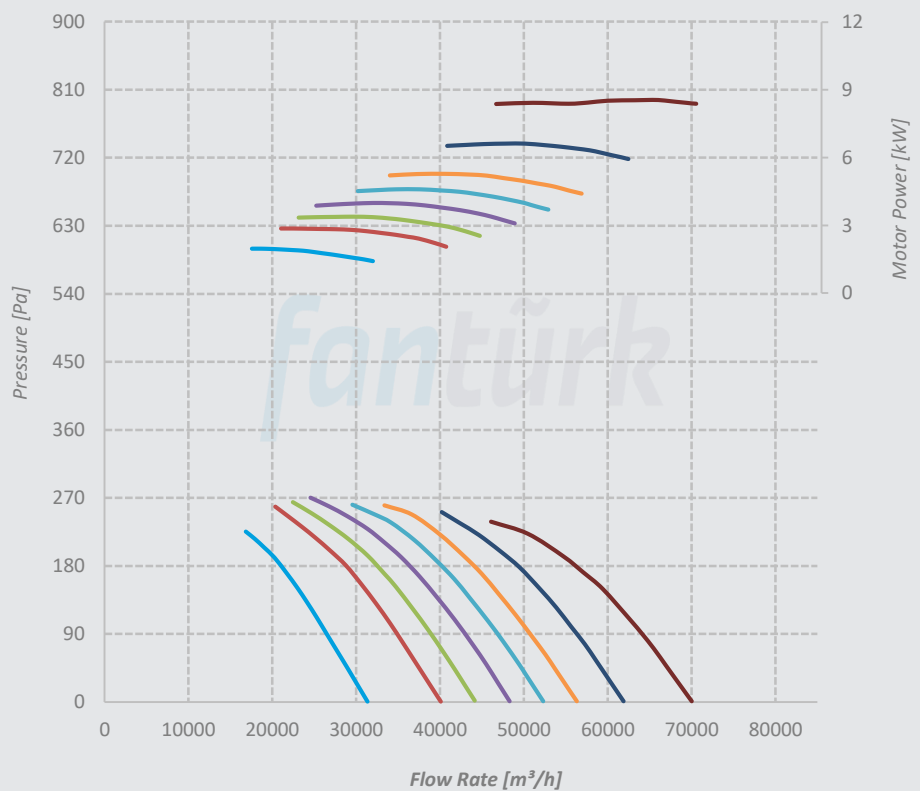

## Performance Curves

### P-FWA 1120 Y-FWA 1120 H-FWA 1120 Ç-FWA 1120

Nos. of Blades 12  
Hub Size 12  
Nos. of Poles 4  
Material Aluminum  
Pitch Angle

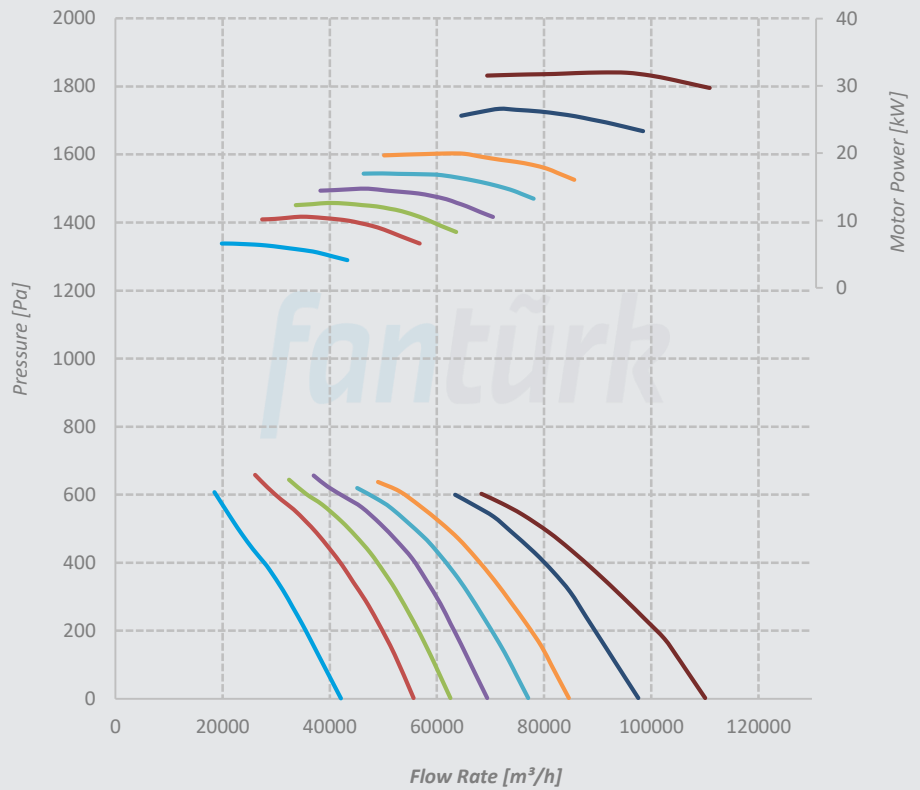
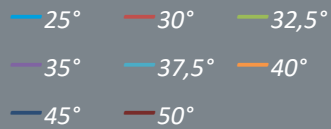

### P-FWA 1120 Y-FWA 1120 H-FWA 1120 Ç-FWA 1120

Nos. of Blades 12  
Hub Size 12  
Nos. of Poles 6  
Material Aluminum  
Pitch Angle

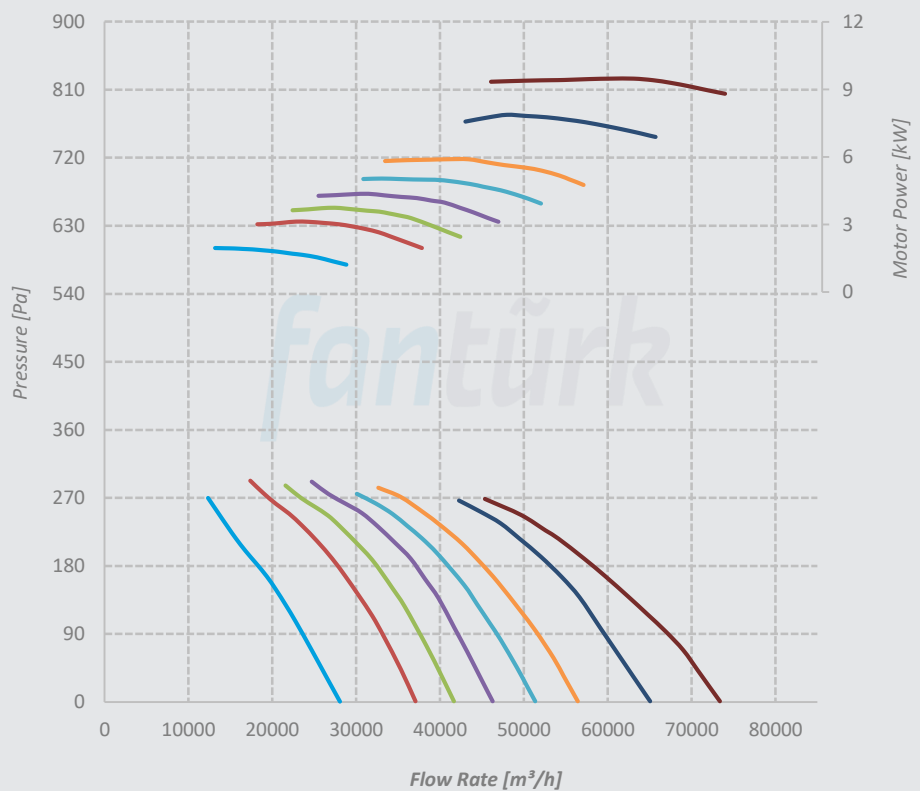
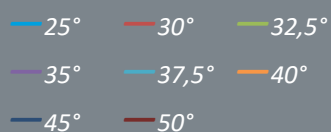

## Performance Curves

### P-FWA 1250 Y-FWA 1250 H-FWA 1250 Ç-FWA 1250

Nos. of Blades 8  
Hub Size 16  
Nos. of Poles 4  
Material Aluminum  
Pitch Angle

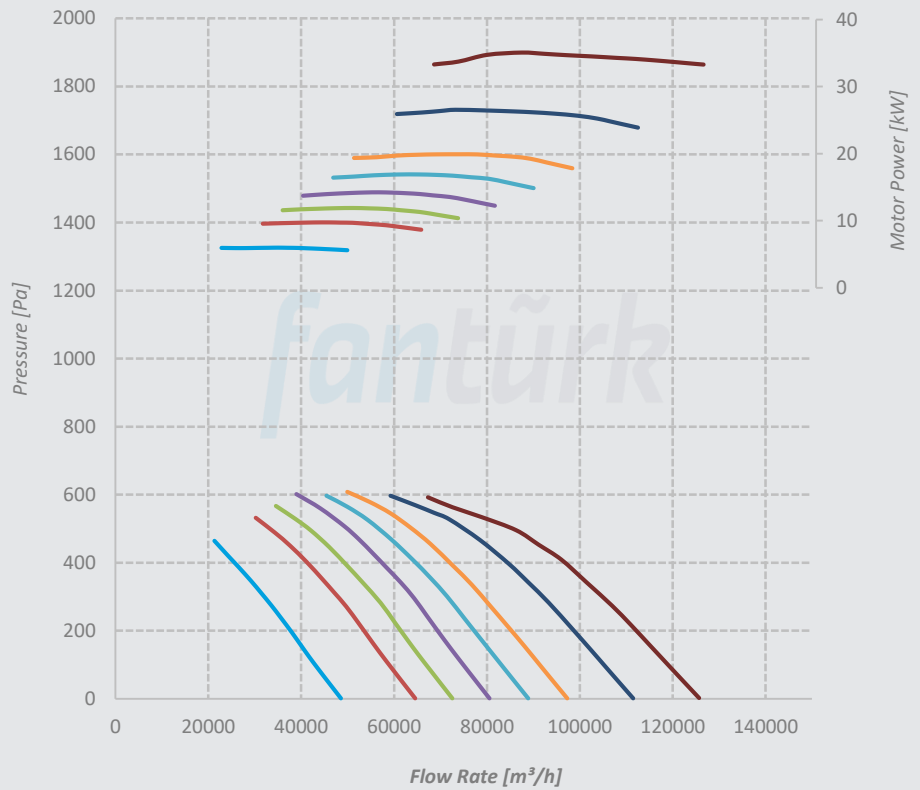
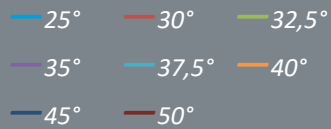

### P-FWA 1250 Y-FWA 1250 H-FWA 1250 Ç-FWA 1250

Nos. of Blades 8  
Hub Size 16  
Nos. of Poles 6  
Material Aluminum  
Pitch Angle

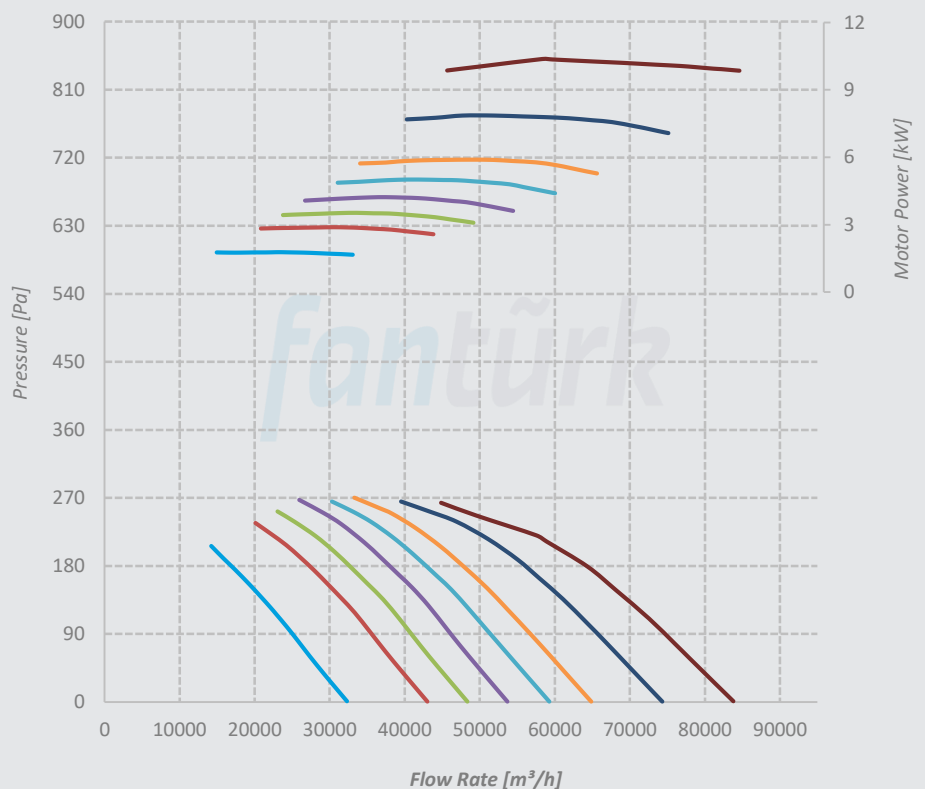
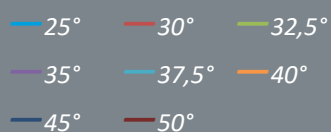

# Performance Curves

**P-FWA 1250**  
**Y-FWA 1250**  
**H-FWA 1250**  
**Ç-FWA 1250**

Nos. of Blades 12  
 Hub Size 16  
 Nos. of Poles 4  
 Material Aluminum  
 Pitch Angle

- 25°    — 30°    — 32,5°
- 35°    — 37,5°    — 40°
- 45°    — 50°

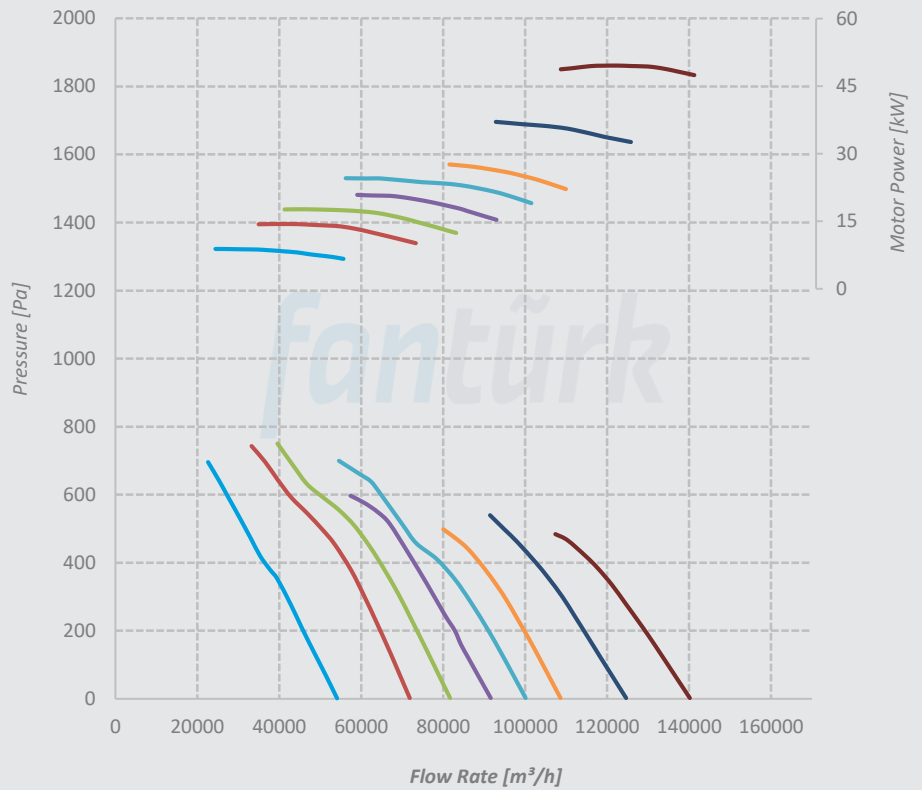

**P-FWA 1250**  
**Y-FWA 1250**  
**H-FWA 1250**  
**Ç-FWA 1250**

Nos. of Blades 12  
 Hub Size 16  
 Nos. of Poles 6  
 Material Aluminum  
 Pitch Angle

- 25°    — 30°    — 32,5°
- 35°    — 37,5°    — 40°
- 45°    — 50°

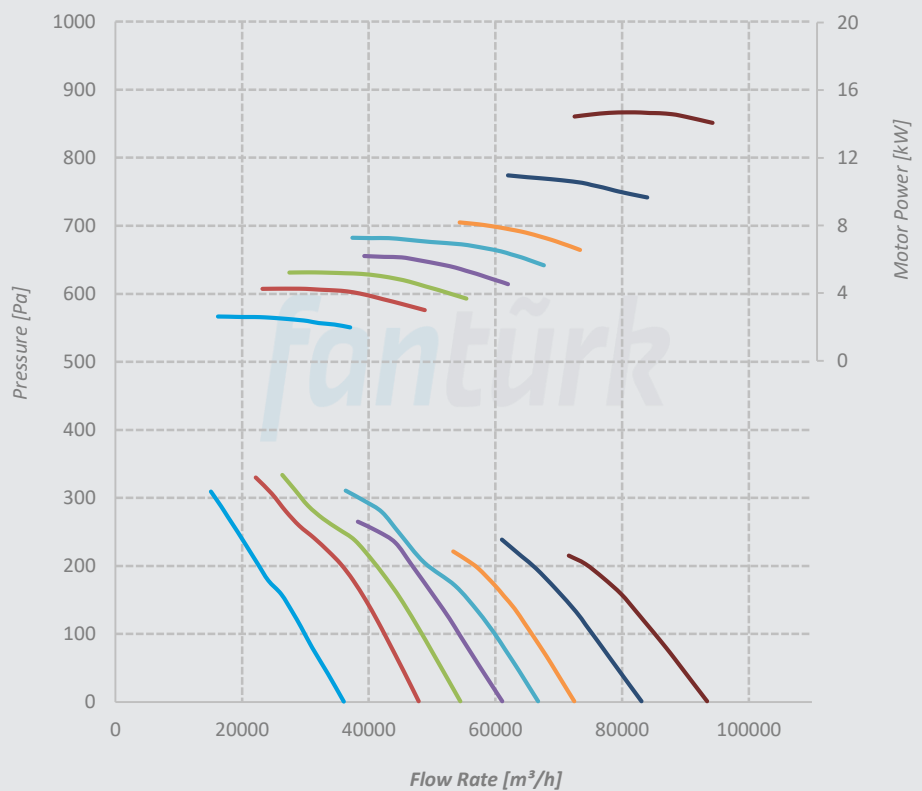

# Performance Curves

**P-FWA 1250**  
**Y-FWA 1250**  
**H-FWA 1250**  
**Ç-FWA 1250**

Nos. of Blades 16  
 Hub Size 16  
 Nos. of Poles 4  
 Material Aluminum  
 Pitch Angle

- 25°    — 30°    — 32,5°
- 35°    — 37,5°    — 40°
- 45°    — 50°

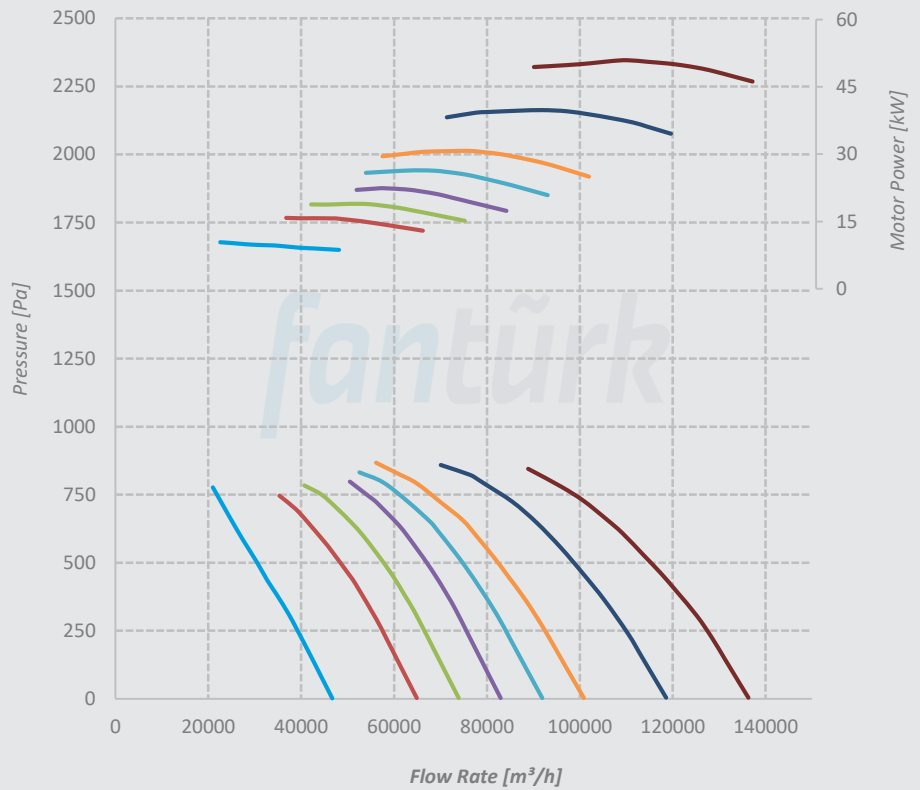

**P-FWA 1250**  
**Y-FWA 1250**  
**H-FWA 1250**  
**Ç-FWA 1250**

Nos. of Blades 16  
 Hub Size 16  
 Nos. of Poles 6  
 Material Aluminum  
 Pitch Angle

- 25°    — 30°    — 32,5°
- 35°    — 37,5°    — 40°
- 45°    — 50°

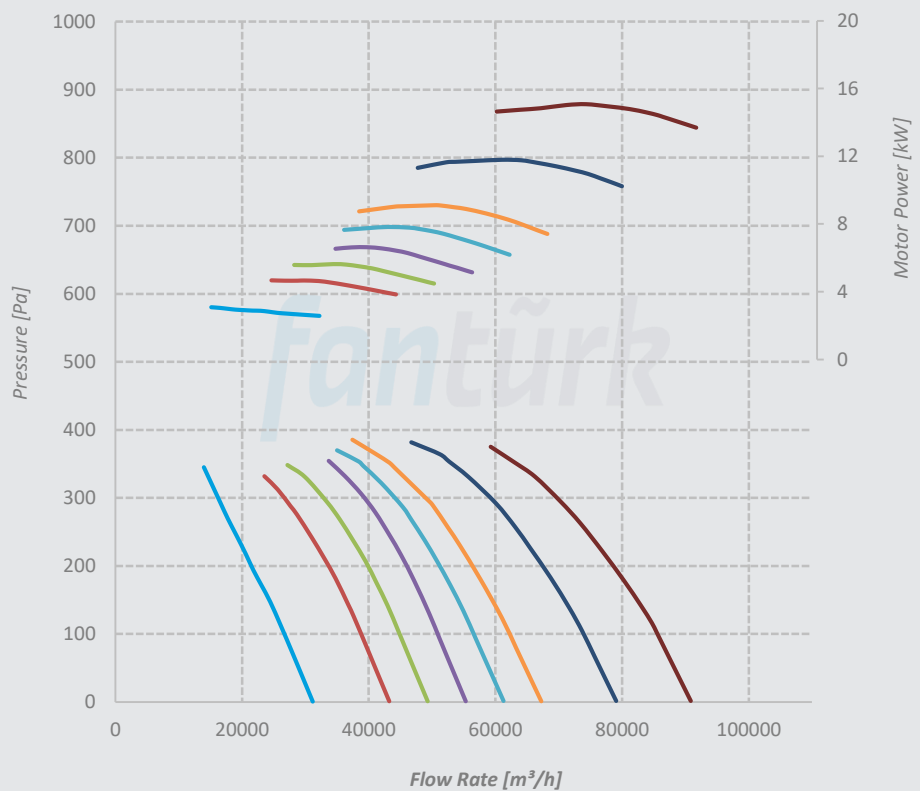



# D-FWA Wall Mounted Axial Fan



## Technical Specifications

# WALL MOUNTED AXIAL FAN

D-FWA series wall mounted axial fans are the ideal fans for wall mounting in ventilation systems where high air flow is required. Thanks to their compact construction, they can be mounted directly on the wall. D-FWA series wall mounted axial fans have high performance, trouble-free operation.

It is manufactured between  $\varnothing 500\text{mm}$  and  $\varnothing 1000\text{mm}$  diameters. The body is made of high quality, corrosion-resistant galvanized steel. The propellers are made of special aluminum alloy with adjustable blade angles. It is manufactured as standard (380 V - 50 Hz) or other voltages and frequencies. Motors can be single-speed or double speed and have Class H, S1, IP55 insulation.

Optionally, it can be manufactured with Ex-Proof feature.

### Usage Areas

It can be used in all kinds of industrial, office, warehouse, hangar, workshop and residential projects to meet the ventilation requirement.

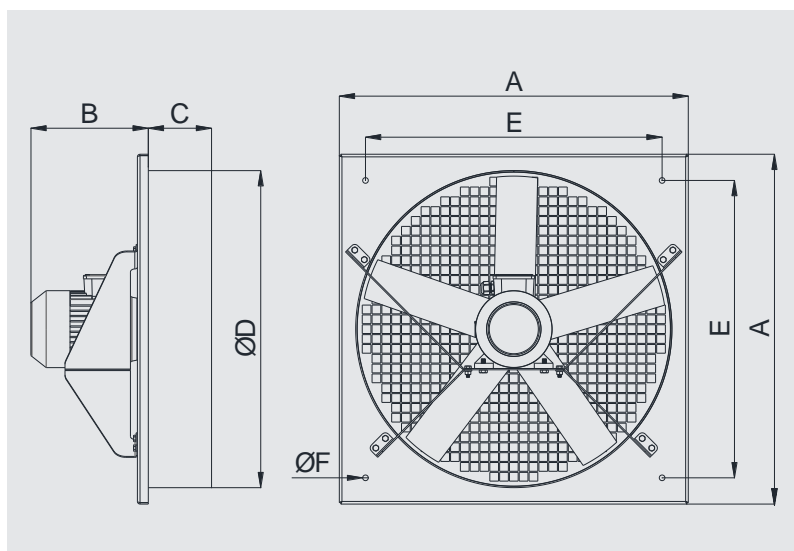
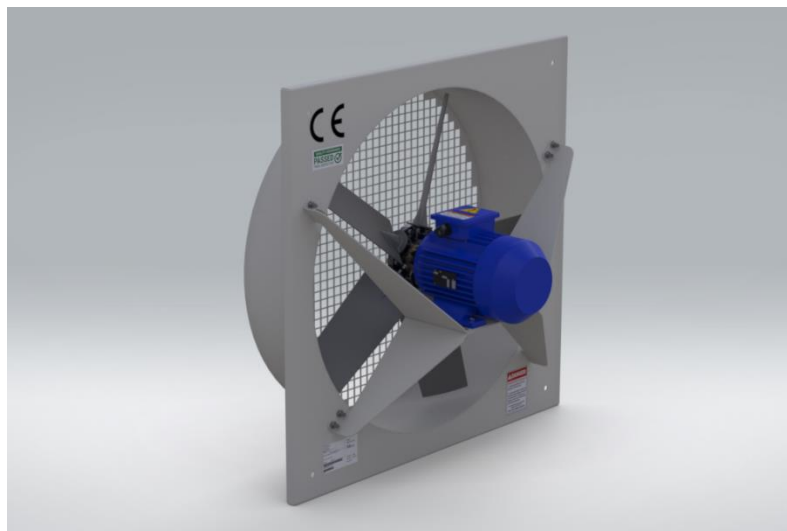

MODEL	A	B	C	D	E	F	MOTOR POWER	CURRENT	NOS. OF POLES	VOLTAGE	FREQUENCY
	mm	mm	mm	mm	mm	mm	kW	A		V	Hz
D-FWA 400	500	210	105	420	380	13	0,18	0,6	4	380	50
D-FWA 450	550	227	105	470	430	13	0,37	1,1	4	380	50
D-FWA 500	600	227	105	520	480	13	0,55	1,6	4	380	50
D-FWA 600	700	247	105	620	580	13	0,75	2,1	4	380	50
D-FWA 700	800	265	145	725	680	13	1,1	2,6	4	380	50
D-FWA 800	950	316	195	825	830	13	2,2	5,1	4	380	50
D-FWA 900	1050	335	220	925	930	15	4	8,2	4	380	50
D-FWA 1000	1150	355	220	1025	1030	15	5,5	11,3	4	380	50



## Performance Curves

### D-FWA 400

Nos. of Blades 5  
Hub Size 5  
Pitch Angle 35°  
Nos. of Poles 4  
Material Aluminum

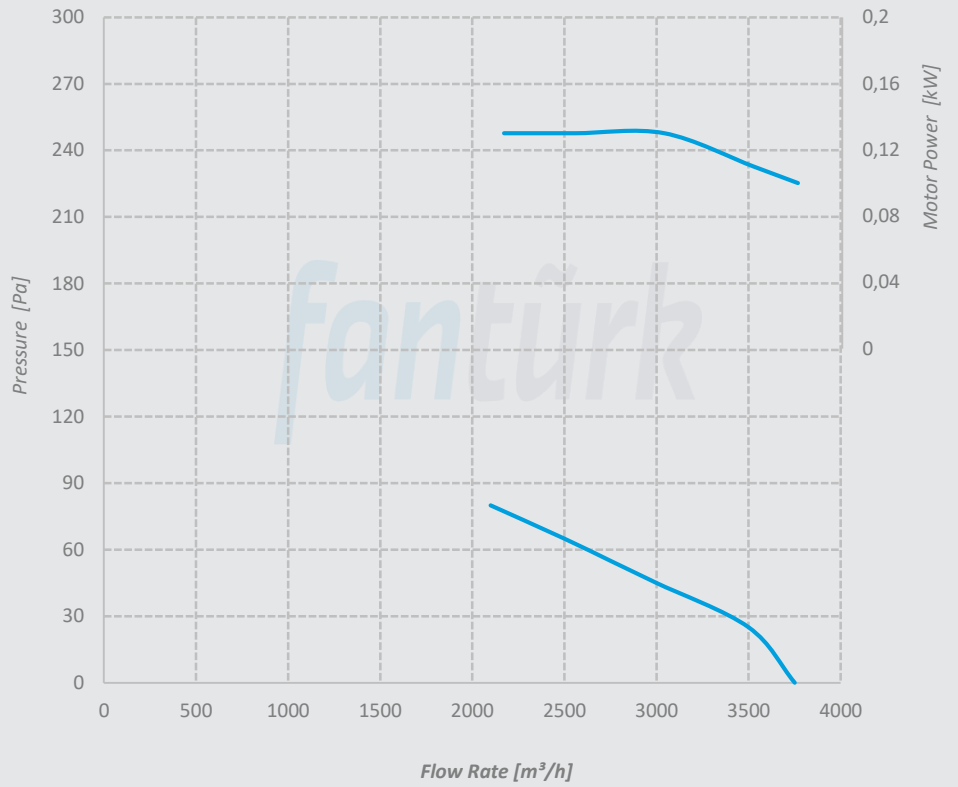

### D-FWA 450

Nos. of Blades 5  
Hub Size 5  
Pitch Angle 30°  
Nos. of Poles 4  
Material Aluminum

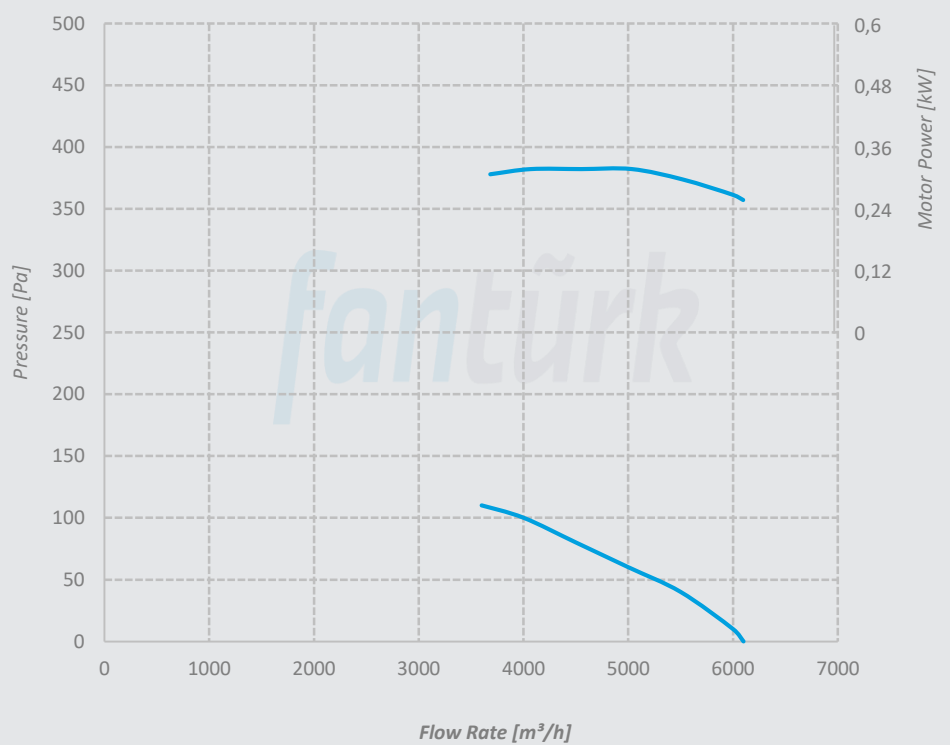

## Performance Curves

### D-FWA 500

Nos. of Blades 5  
 Hub Size 5  
 Pitch Angle 35°  
 Nos. of Poles 4  
 Material Aluminum

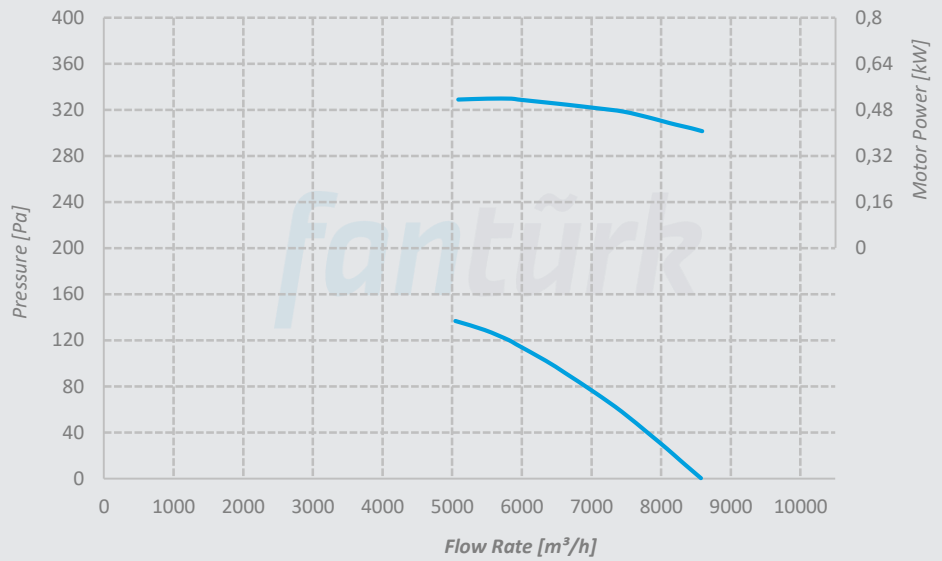

### D-FWA 600

Nos. of Blades 5  
 Hub Size 5  
 Pitch Angle 30°  
 Nos. of Poles 4  
 Material Aluminum

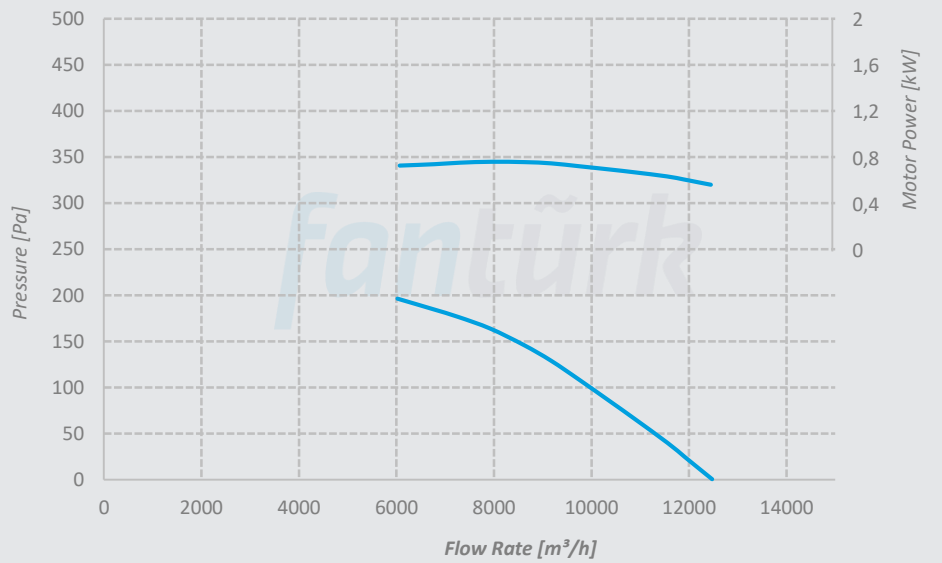

### D-FWA 700

Nos. of Blades 5  
 Hub Size 5  
 Pitch Angle 25°  
 Nos. of Poles 4  
 Material Aluminum

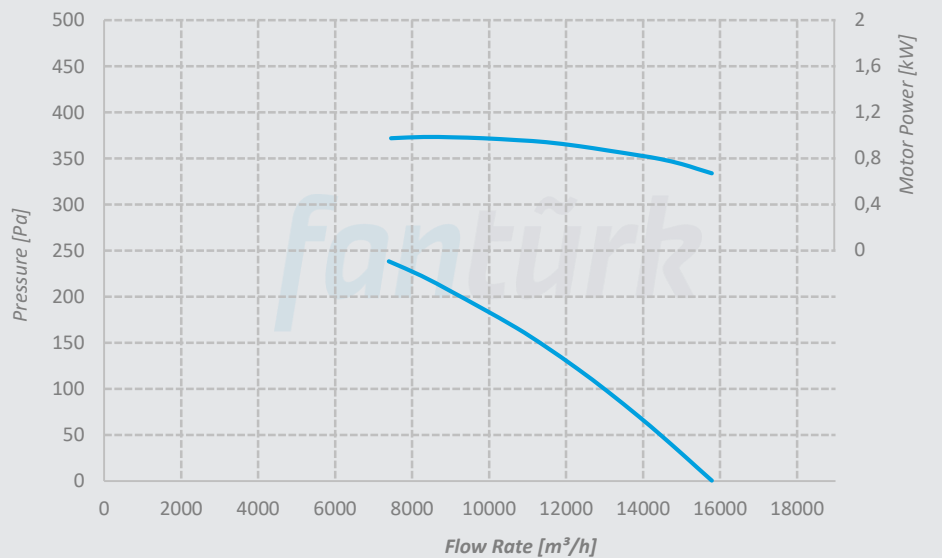

## Performance Curves

### D-FWA 800

Nos. of Blades 5  
 Hub Size 5  
 Pitch Angle 30°  
 Nos. of Poles 4  
 Material Aluminum

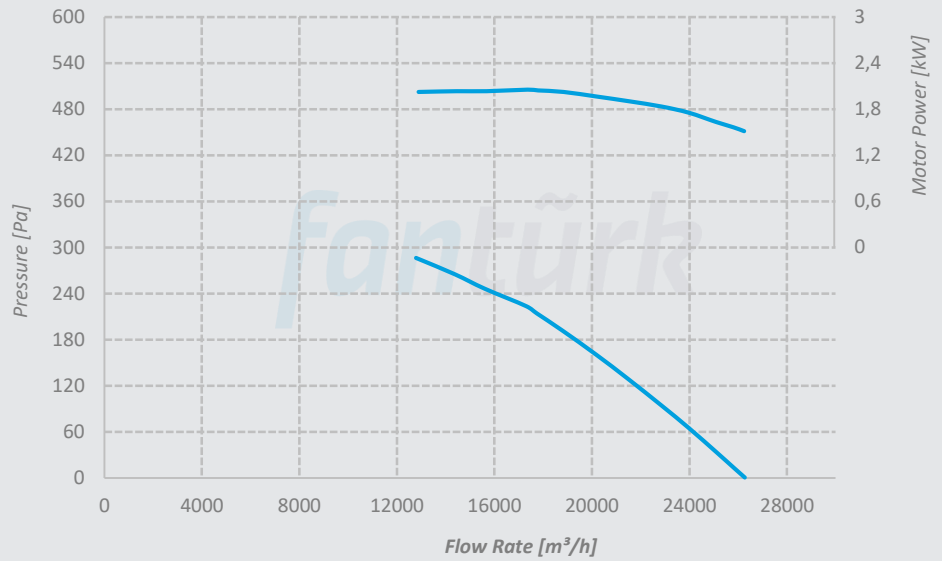

### D-FWA 900

Nos. of Blades 5  
 Hub Size 5  
 Pitch Angle 35°  
 Nos. of Poles 4  
 Material Aluminum

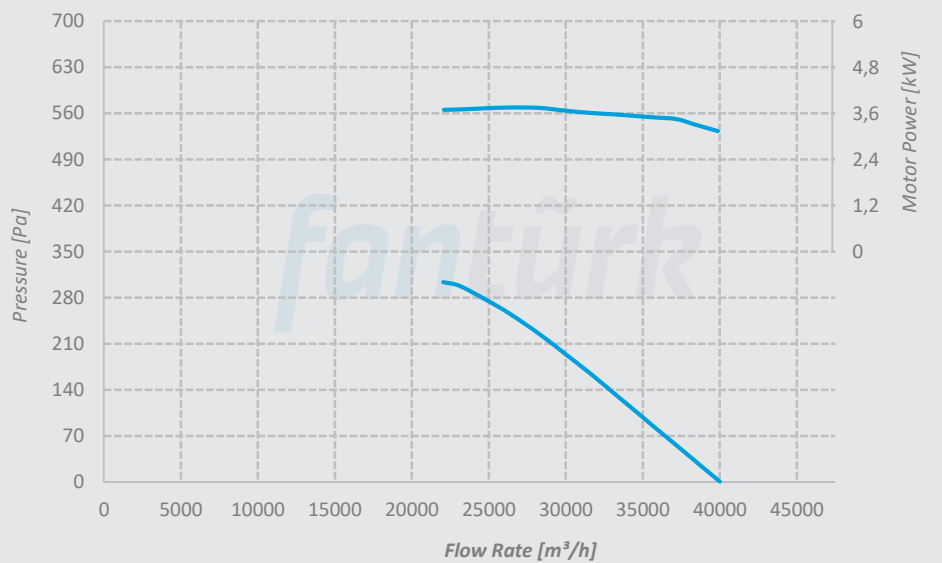

### D-FWA 1000

Nos. of Blades 5  
 Hub Size 5  
 Pitch Angle 37,5°  
 Nos. of Poles 4  
 Material Aluminum

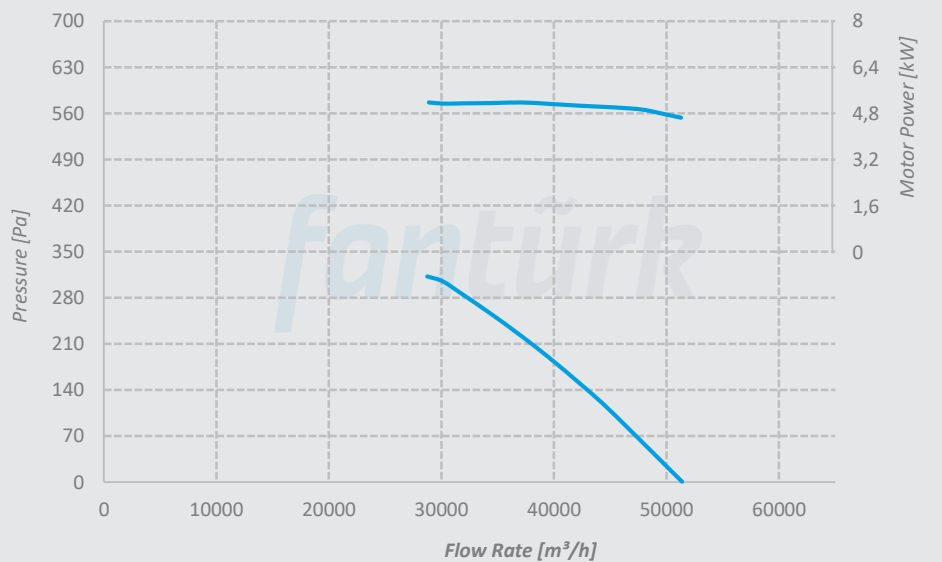



# T-FWA Tunnel Jet Fan



## General Features

*The products have fire-resistant certificate and tested for working for 2 hours at 400 °C in international accredited organizations according to EN 12101-3 standard.*

*It is manufactured between Ø560mm and Ø1600mm diameters.*

*According to the Project two-speed or single-speed options are available. Reversible propeller is standart.*

### **Fan Body**

*T-FWA Axial Jet Fan models are manufactured from high quality S355 sheet.*

### **Propeller**

*The propellers are made of special aluminum alloy with adjustable blade angles. According to the project, it can operate in the same performance in both blowing directions thanks to its reversible blade structure. Complies with international standards.*

### **Motor**

*It is manufactured as standard (380 V - 50 Hz) or other voltages and frequencies (400/415/440 V -50 Hz) on request. As a standard, Class H, S1, IP55 single-speed or double-speed motors with a resistance of 2 hours to 400 degrees are used.*

### **Accessories**

*In this series, the sound volume increases due to the high air outlet velocities and therefore tunnel jet fans are used as standard with the silencer.*



## Technical Specifications

# TUNNEL JET FAN

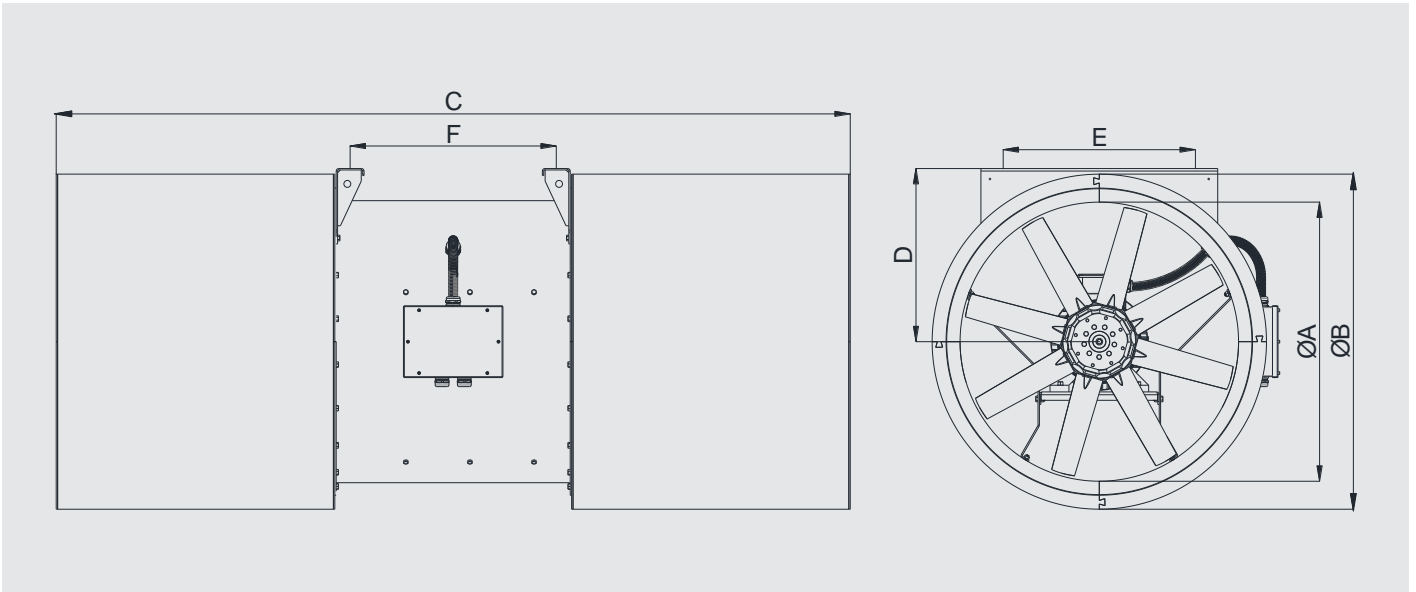

MODEL	A	B	C	D	E	F	VOLTAGE	FREQUENCY	MOTOR POWER	NOS. OF POLES	FLOW RATE	MAX. AIR VELOCITY	THRUST	WEIGHT
	mm	mm	mm	mm	mm	mm	V	Hz	kW		m <sup>3</sup> /s	m/s	N	kg
T-FWA 560	560	760	1820	400	390	590	380	50	7,5	2	6,8	27,6	225	256
									11		7,9	32,1	305	305
T-FWA 630	630	830	1960	435	440	590	380	50	15	2	10,2	32,7	399	346
									18,5		10,7	34,4	443	368
T-FWA 710	710	910	2120	475	490	590	380	50	22	2	13,1	33	518	445
									30		14,9	37,6	670	485
T-FWA 800	800	1000	2450	520	590	740	380	50	7,5	4	11,1	22,2	296	396
									11		12,2	24,2	354	445
T-FWA 900	900	1100	2650	570	640	740	380	50	15	4	16,7	26,2	525	514
									18,5		17,9	28,2	605	536
T-FWA 1000	1000	1200	2850	620	690	740	380	50	22	4	22,1	28,2	749	636
									30		24,9	31,7	950	676
T-FWA 1120	1120	1320	3240	680	790	890	380	50	37	4	32,4	32,8	1275	815
									45		33,8	34,4	1395	918
T-FWA 1250	1250	1450	3600	745	890	990	380	50	45	4	38,5	31,4	1450	1043
									55		41,9	34,1	1715	1145
									75		45,6	37,2	2035	1285
T-FWA 1400	1400	1600	3900	820	990	990	380	50	45	6	46	29,9	1648	1169
									55		48,1	31,2	1802	1271
T-FWA 1600	1600	1800	4300	920	1190	1190	380	50	45	6	54,1	26,9	1748	1356
									55		59	29,3	2075	1458



# M-FWA Mining Ventilation Fan



## Technical Specifications

# MINING VENTILATION FAN

It is important to dispose of gases released from equipment used in mining areas, to exhaust gas and dust particles resulting from explosions and excavations, and to balance high temperature differences that may occur in the mine area.

Fantürk mining fans stand out with their original design and high efficiency. It meets customer needs with special designs for every working point required in the field. Fans, which are produced as 380V/50 Hz as standard, can be produced in different voltage values upon request.

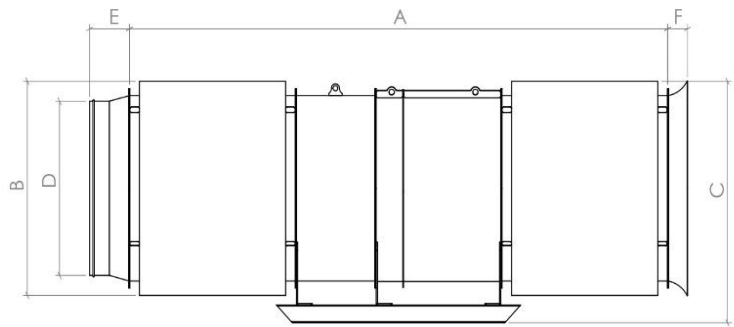
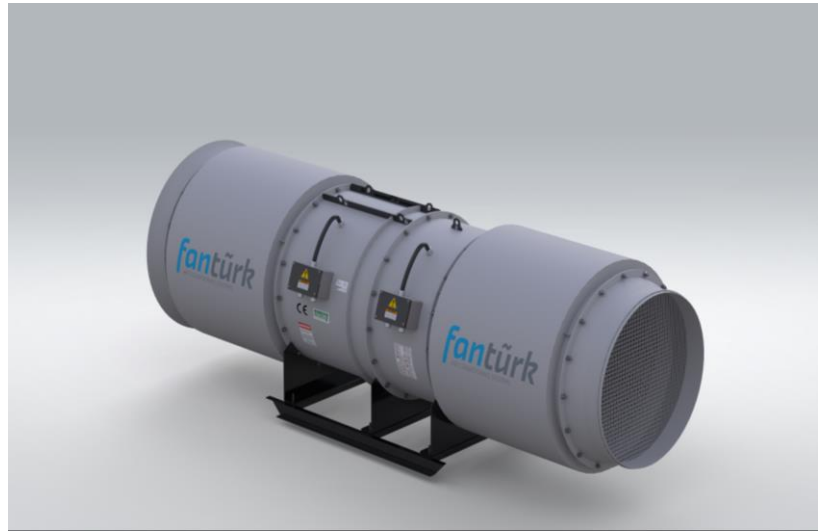

MODEL	A	B	C	D	E	F	VOLTAGE	FREQUENCY	MOTOR POWER	NOS. OF POLES	FLOW RATE	PRESSURE
	mm	mm	mm	mm	mm	mm	V	Hz	kW		m <sup>3</sup> /s	Pa
M-FWA 400	1900	500	650	200...600	150	100	380	50	1.1/1.5 2.2/3/4	2	1.8 - 3.5	700-250
M-FWA 500	2000	600	750	300...700	150	100	380	50	2.2/3/4 5.5/7.5	2	1.9 - 4	1500-250
M-FWA 630	2100	730	880	430...830	150	100	380	50	5.5/7.5/11 15/18.5	2	2-7	2500-300
M-FWA 710	2150	810	910	550...1050	200	120	380	50	11/15/18.5 22/30/37	2	5-14	3000-500
M-FWA 800	3000	950	1150	600...1200	200	120	380	50	22/30 37/45	2	5-18	3200-600
M-FWA 900	3200	1050	1250	600...1300	200	120	380	50	30/37/45 55/75/90	2	6-23	3500-800
M-FWA 1000	4000	1150	1350	700...1400	200	130	380	50	45/55 75/90/110	2	10-35	4000-600
M-FWA 1250	4250	1400	1600	800...1500	200	145	380	50	45/55 75/90/110	4	11-40	2500-400
M-FWA 1400	5000	1600	1800	1000...1800	250	150	380	50	75/90 110/130	4	17-50	2500-600





# ABF Low Pressure Centrifugal Fan



## Technical Specifications

# LOW PRESSURE CENTRIFUGAL FAN

ABF series are single suction high efficiency and low noise fans. The maximum temperature of the suction fluid should be 120 °C. In order to work at a higher temperature, modifications to the fan manufacturing are required.

Made of high quality corrosion resistant S355 steel and coated with epoxy paint. Can be made of stainless steel for corrosive and high temperature environments. Fans are radial fans with backward curved blades. It is possible to drive the fan with belt pulley, direct coupling or elastic coupling.

Optionally, it can be manufactured with Ex-Proof feature.

### Usage Areas

It can be used for suction of clean and light dusty fluids, cooling, ventilation, drying, mechanical extraction and toxic gas exhaust.

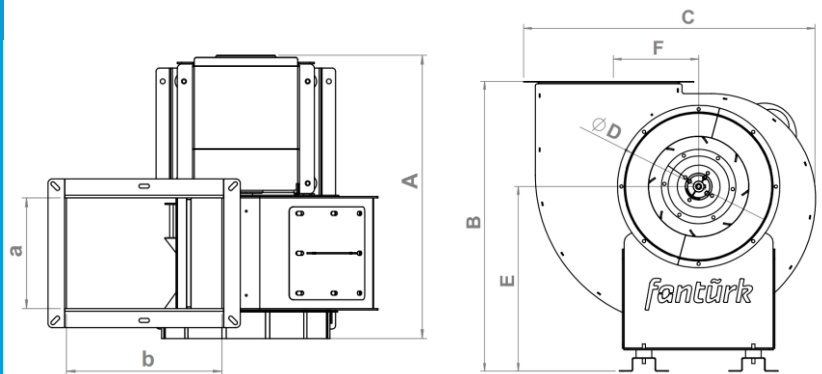

MODEL	A	B	C	Inlet	Outlet	E	F	VOLTAGE	FREQUENCY	MOTOR POWER	CURRENT	MOTOR SPEED	SOUND P. LEVEL	WEIGHT
	mm	mm	mm	∅D	a x b									
ABF 250/0,25	640	740	745	381	250 x 352	472	230	380	50	0,25	0,9	1360	64	58
ABF 250/0,37	640							380	50	0,37	1,2	1360	65	59
ABF 250/2,2	640							380	50	2,2	4,5	2850	77	68
ABF 250/3	640							380	50	3	6	2900	78	74
ABF 280/0,55	650	830	830	422	280 x 400	510	250	380	50	0,55	1,6	1370	67	71
ABF 280/4	690							380	50	4	7,4	2900	79	86
ABF 280/5,5	725							380	50	5,5	11	2900	82	102
ABF 315/1,1	715	908	912	522	315 x 450	570	280	380	50	1,1	2,6	1390	70	94
ABF 315/7,5	765							380	50	7,5	13,6	2900	84	125
ABF 315/11	895							380	50	11	19,5	2930	85	166
ABF 355/0,37	755	1005	1040	522	355 x 500	642	328	380	50	0,37	1,2	930	60	123
ABF 355/0,55	755							380	50	0,55	1,6	930	62	124
ABF 355/2,2	755							380	50	2,2	5	1420	72	137
ABF 355/15	950							380	50	15	28,3	2935	79	204
ABF 355/18,5	950							380	50	18,5	34	2935	82	237
ABF 400/1,1	805							1105	1135	568	400 x 556	702	357	380
ABF 400/4	820	380	50	4	8,2	1430	73							151
ABF 450/2,2	920	1300	1285	644	450 x 627	840	400	380	50	2,2	5,4	950	68	181
ABF 450/5,5	920							380	50	5,5	11,2	1440	75	198
ABF 450/7,5	920							380	50	7,5	15,4	1450	76	208
ABF 500/4	970	1430	1450	728	500 x 706	880	460	380	50	4	9	960	71	246
ABF 500/11	1055							380	50	11	21	1460	78	296
ABF 500/15	1055							380	50	15	29,3	1460	79	302
ABF 560/5,5	1085	1755	1617	818	560 x 800	1173	510	380	50	5,5	12,3	950	74	315
ABF 560/7,5	1120							380	50	7,5	15	960	75	349
ABF 560/18,5	1175							380	50	18,5	34,5	1460	82	416
ABF 560/22	1175							380	50	22	42,5	1460	83	426

## Fan Directions



The centrifugal fan direction must be specified when ordering.

To determine the fan direction, one of the following options is selected when looking from the motor side.



<b>Counter Clockwise</b>	<b>TR</b> Top Right	<b>TR45</b> Top Right 45°	<b>LT</b> Left Top	<b>LT45</b> Left Top 45°
	<b>BL</b> Bottom Left	<b>BL45</b> Bottom Left 45°	<b>RB</b> Right Bottom	<b>RB45</b> Right Bottom 45°
<b>Clockwise</b>	<b>TL</b> Top Left	<b>TL45</b> Top Left 45°	<b>RT</b> Right Top	<b>RT45</b> Right Top 45°
	<b>BR</b> Bottom Right	<b>BR45</b> Bottom Right 45°	<b>LB</b> Left Bottom	<b>LB45</b> Left Bottom 45°

## Performance Curves

### ABF 250/0,25

Voltage 380 V  
Frequency 50 Hz  
Motor Power 0,25 kW  
Motor Speed 1360 rpm  
Sound Pressure Level 64 dBA  
Weight 58 kg

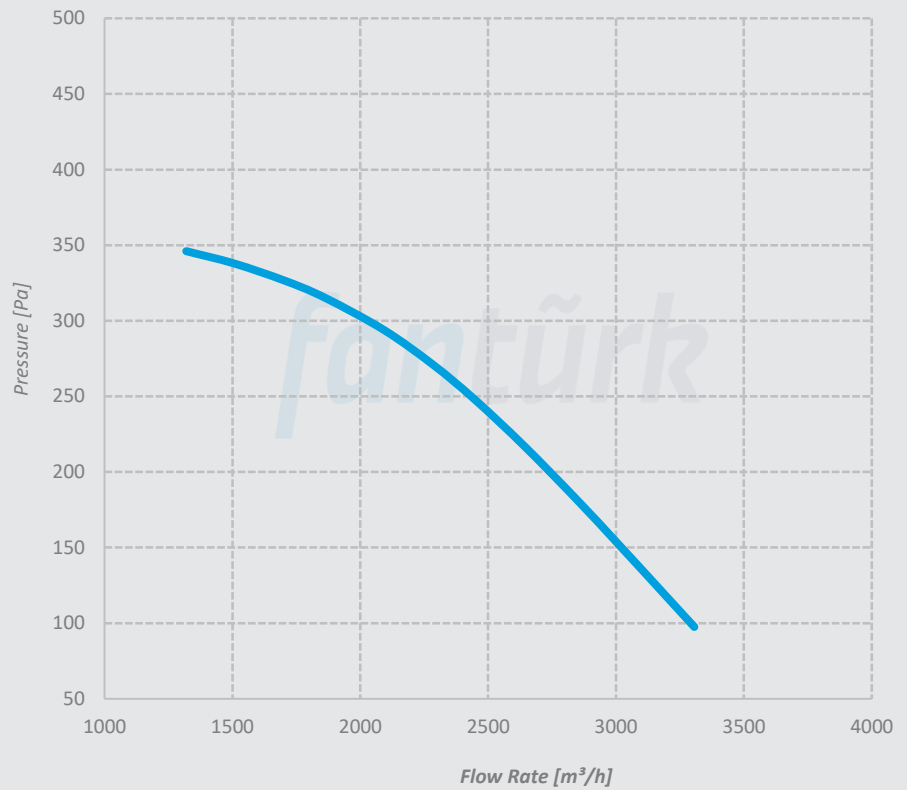

### ABF 250/0,37

Voltage 380 V  
Frequency 50 Hz  
Motor Power 0,37 kW  
Motor Speed 1360 rpm  
Sound Pressure Level 65 dBA  
Weight 59 kg

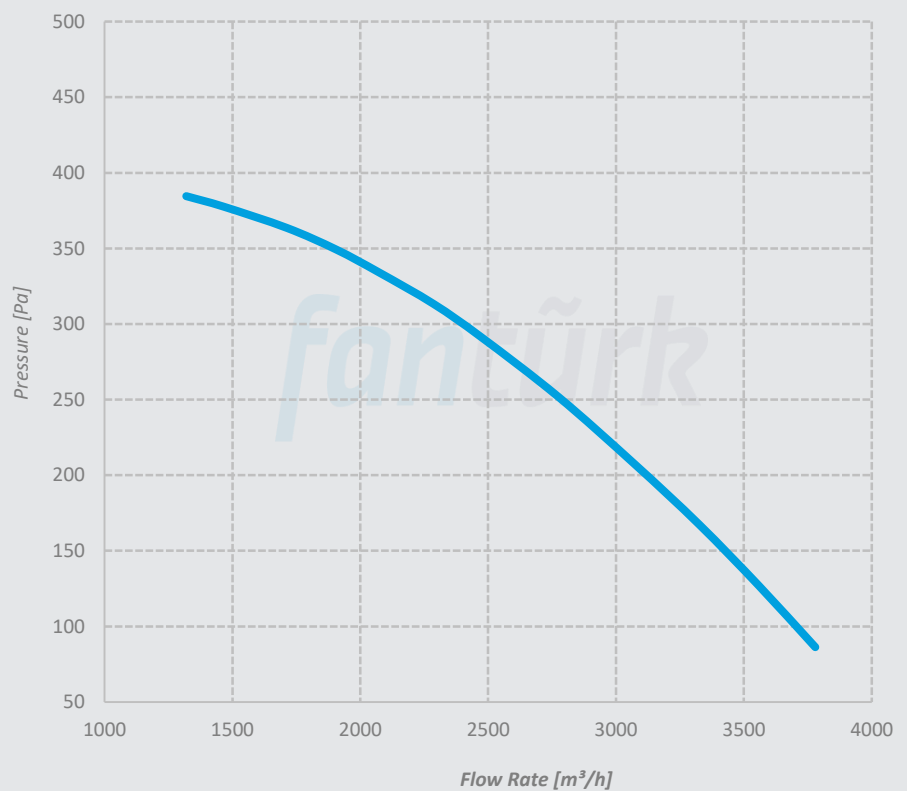

## Performance Curves

### ABF 250/2,2

Voltage 380 V  
Frequency 50 Hz  
Motor Power 2,2 kW  
Motor Speed 2850 rpm  
Sound Pressure Level 77 dBA  
Weight 68 kg

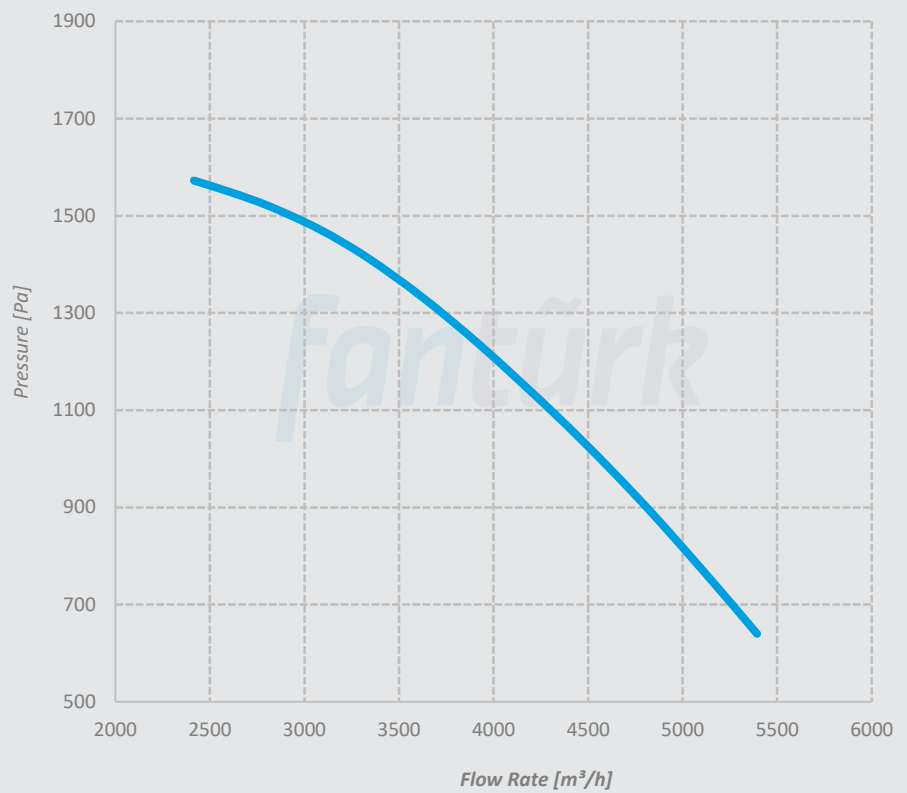

### ABF 250/3

Voltage 380 V  
Frequency 50 Hz  
Motor Power 3 kW  
Motor Speed 2900 rpm  
Sound Pressure Level 78 dBA  
Weight 74 kg

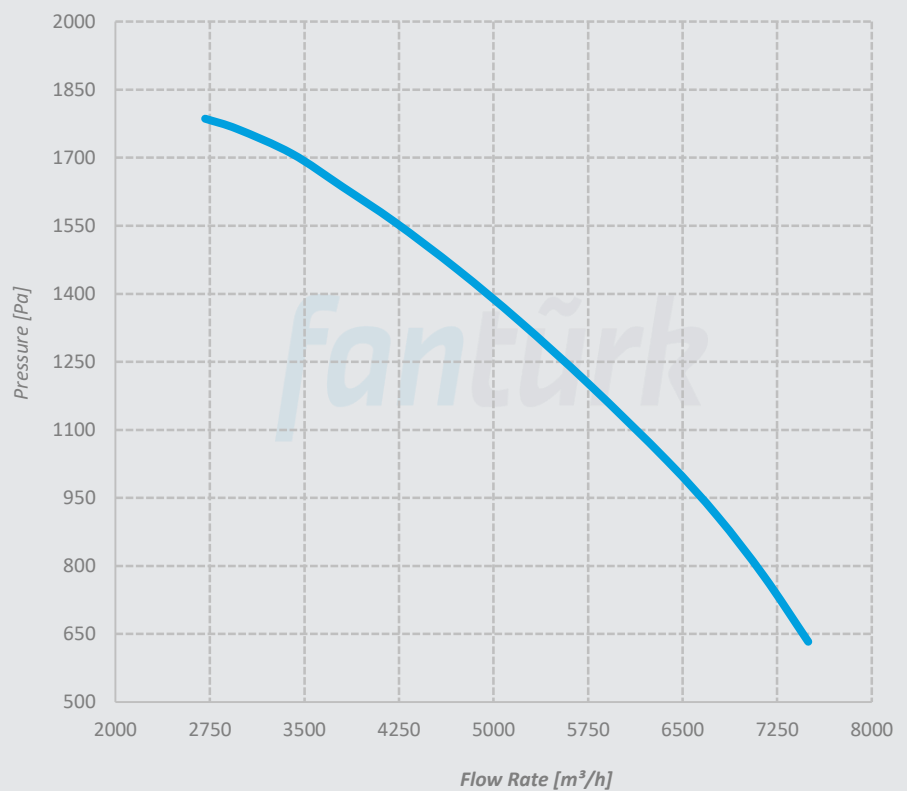

## Performance Curves

### ABF 280/0,55

Voltage 380 V  
Frequency 50 Hz  
Motor Power 0,55 kW  
Motor Speed 1370 rpm  
Sound Pressure Level 67 dBA  
Weight 71 kg

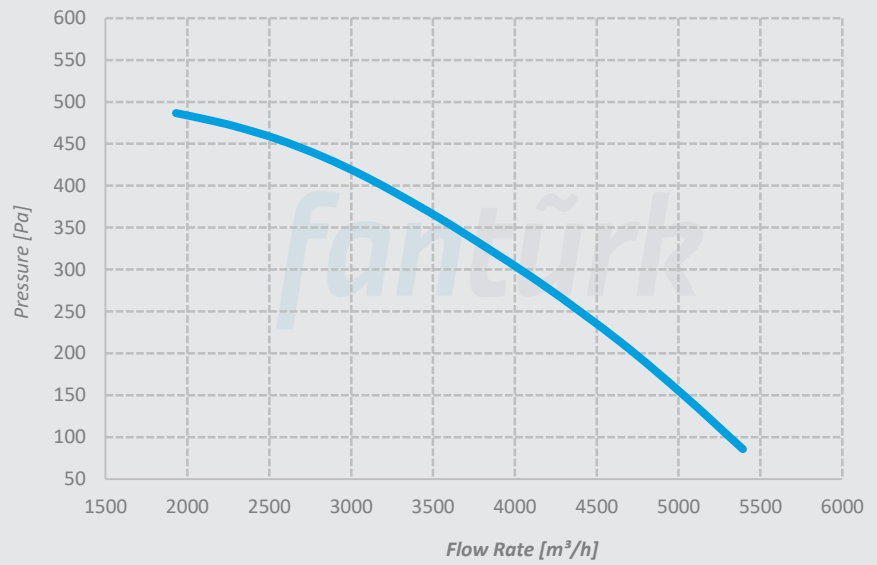

### ABF 280/4

Voltage 380 V  
Frequency 50 Hz  
Motor Power 4 kW  
Motor Speed 2900 rpm  
Sound Pressure Level 79 dBA  
Weight 86 kg

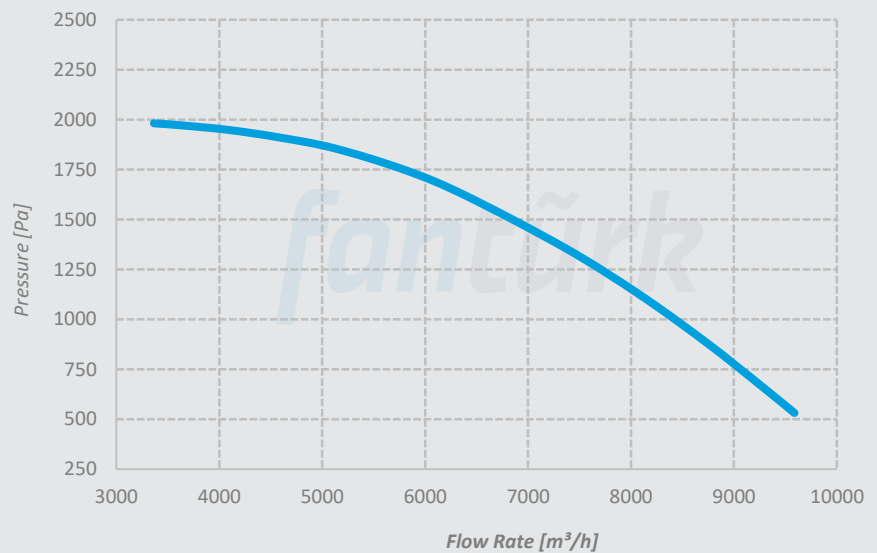

### ABF 280/5,5

Voltage 380 V  
Frequency 50 Hz  
Motor Power 5,5 kW  
Motor Speed 2900 rpm  
Sound Pressure Level 82 dBA  
Weight 102 kg

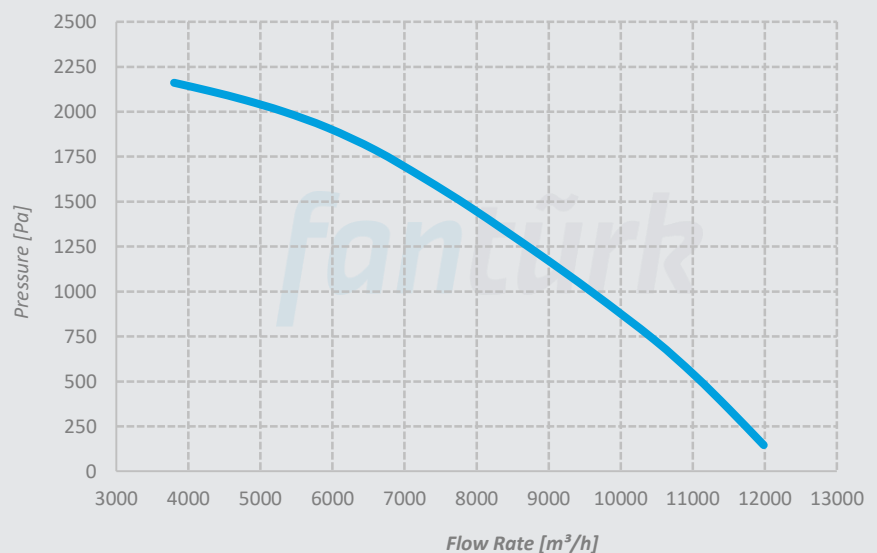

## Performance Curves

### ABF 315/1,1

Voltage 380 V  
Frequency 50 Hz  
Motor Power 1,1 kW  
Motor Speed 1390 rpm  
Sound Pressure Level 70 dBA  
Weight 94 kg

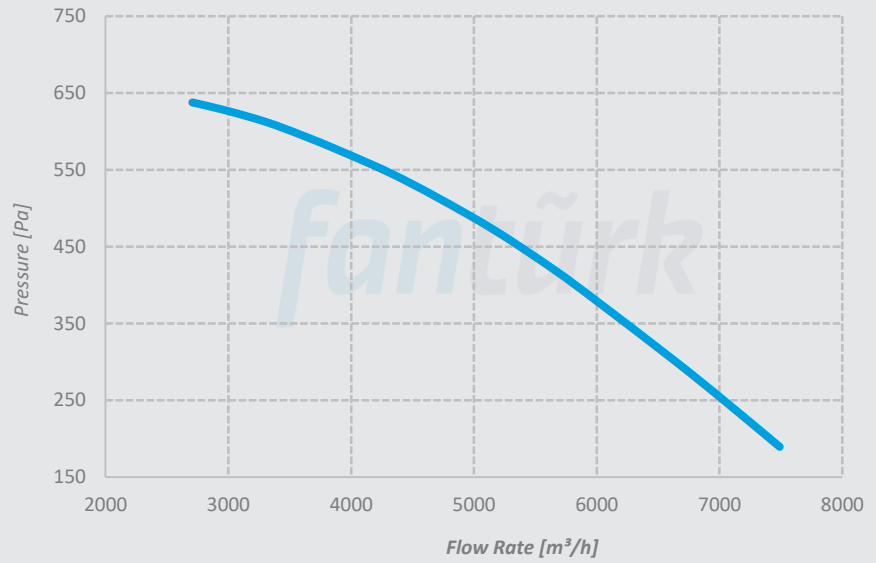

### ABF 315/7,5

Voltage 380 V  
Frequency 50 Hz  
Motor Power 7,5 kW  
Motor Speed 2900 rpm  
Sound Pressure Level 84 dBA  
Weight 125 kg

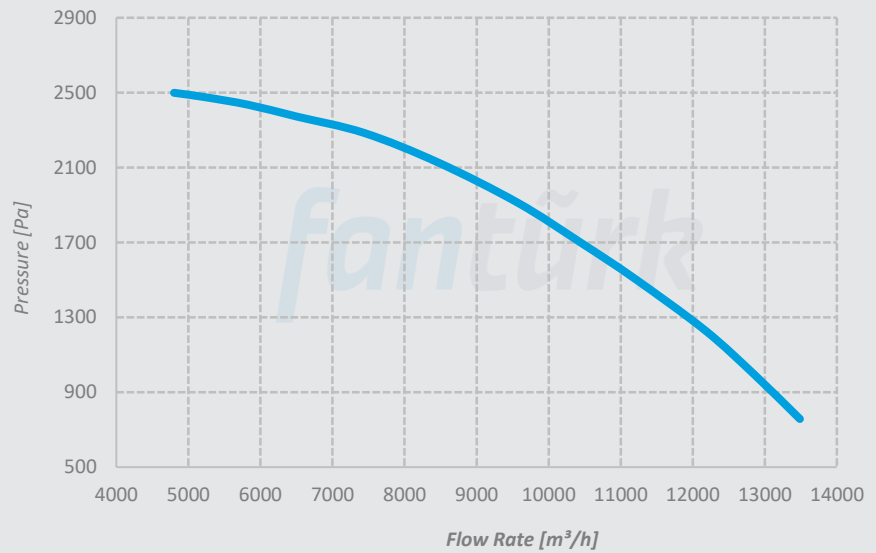

### ABF 315/11

Voltage 380 V  
Frequency 50 Hz  
Motor Power 11 kW  
Motor Speed 2930 rpm  
Sound Pressure Level 85 dBA  
Weight 166 kg

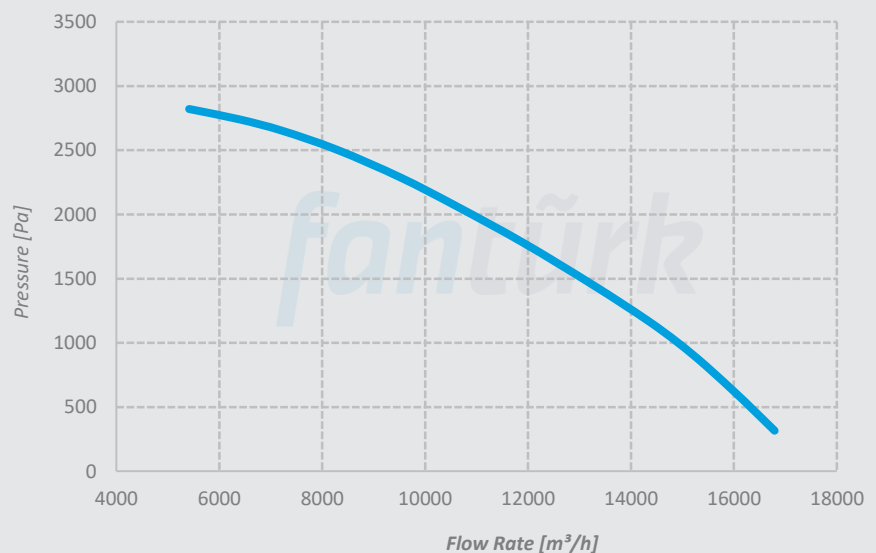

## Performance Curves

### ABF 355/0,37

Voltage 380 V  
Frequency 50 Hz  
Motor Power 0,37 kW  
Motor Speed 930 rpm  
Sound Pressure Level 60 dBA  
Weight 123 kg

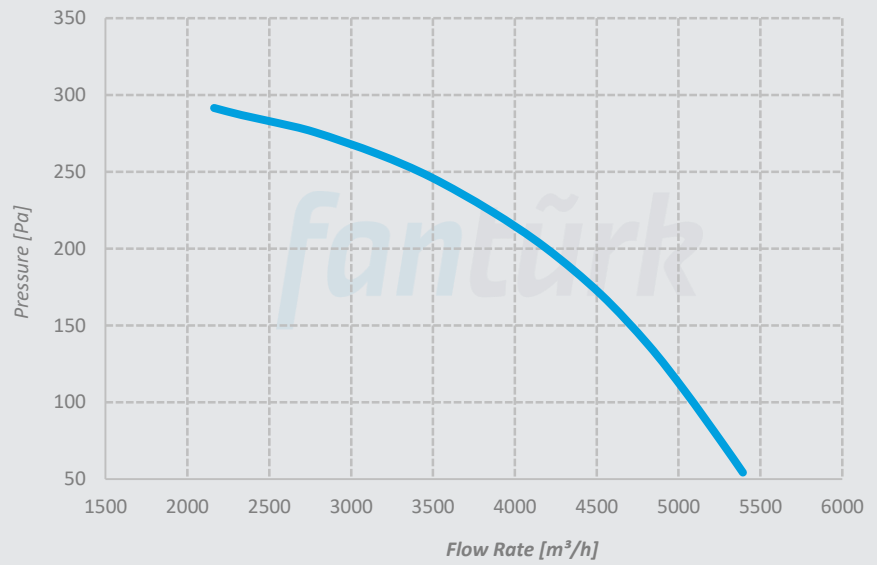

### ABF 355/0,55

Voltage 380 V  
Frequency 50 Hz  
Motor Power 0,55 kW  
Motor Speed 930 rpm  
Sound Pressure Level 62 dBA  
Weight 124 kg

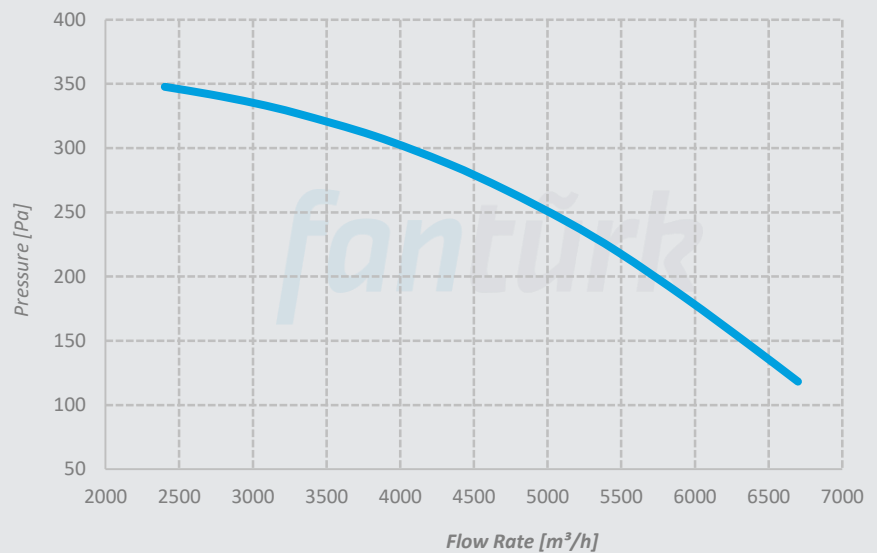

### ABF 355/2,2

Voltage 380 V  
Frequency 50 Hz  
Motor Power 2,2 kW  
Motor Speed 1420 rpm  
Sound Pressure Level 72 dBA  
Weight 137 kg

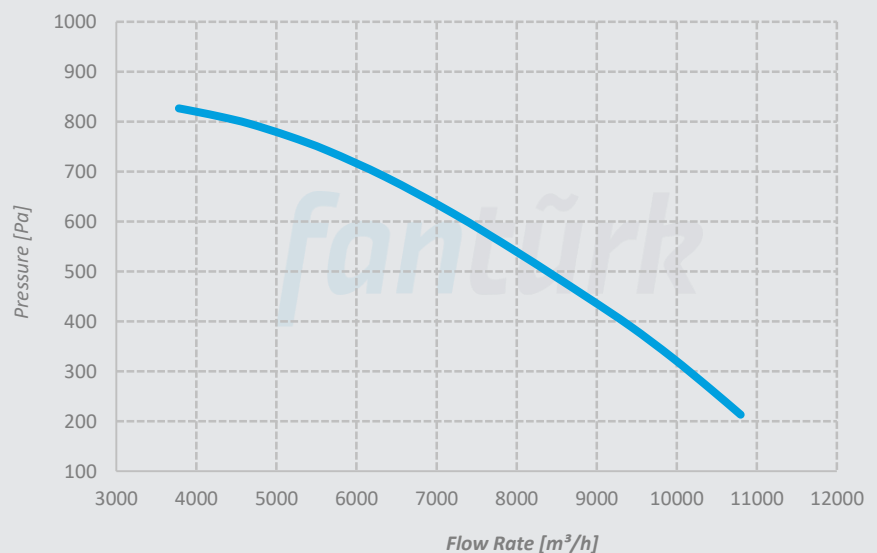



## Performance Curves

### ABF 355/15

Voltage 380 V  
Frequency 50 Hz  
Motor Power 15 kW  
Motor Speed 2935 rpm  
Sound Pressure Level 79 dBA  
Weight 204 kg

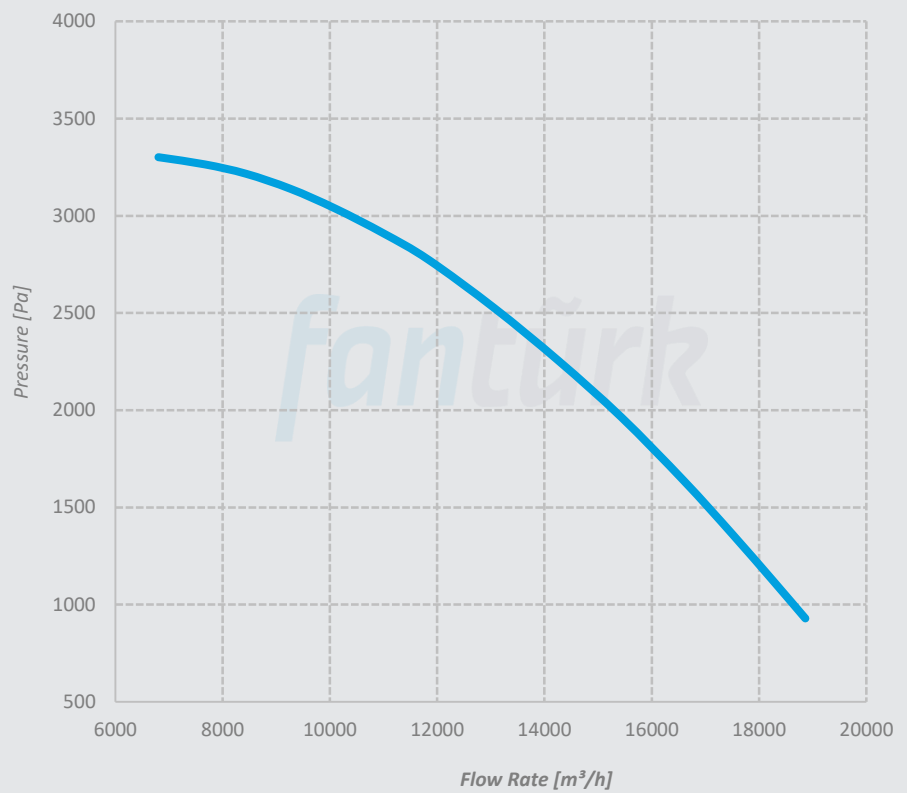

### ABF 355/18,5

Voltage 380 V  
Frequency 50 Hz  
Motor Power 18,5 kW  
Motor Speed 2935 rpm  
Sound Pressure Level 82 dBA  
Weight 237 kg

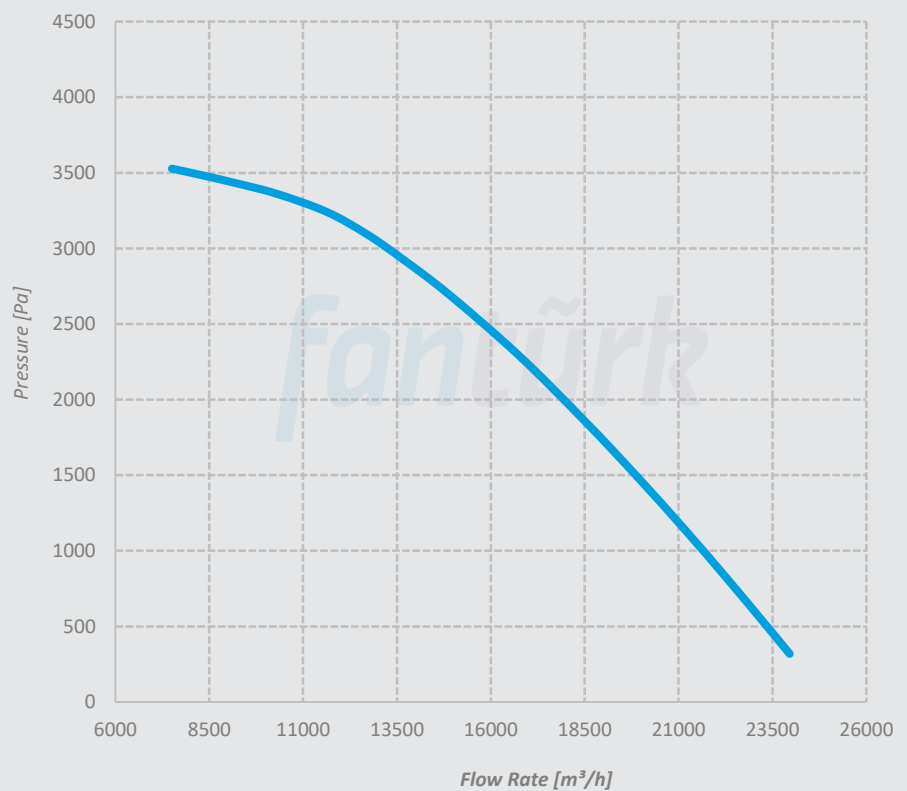

## Performance Curves

### ABF 400/1,1

Voltage 380 V  
Frequency 50 Hz  
Motor Power 1,1 kW  
Motor Speed 930 rpm  
Sound Pressure Level 65 dBA  
Weight 130 kg

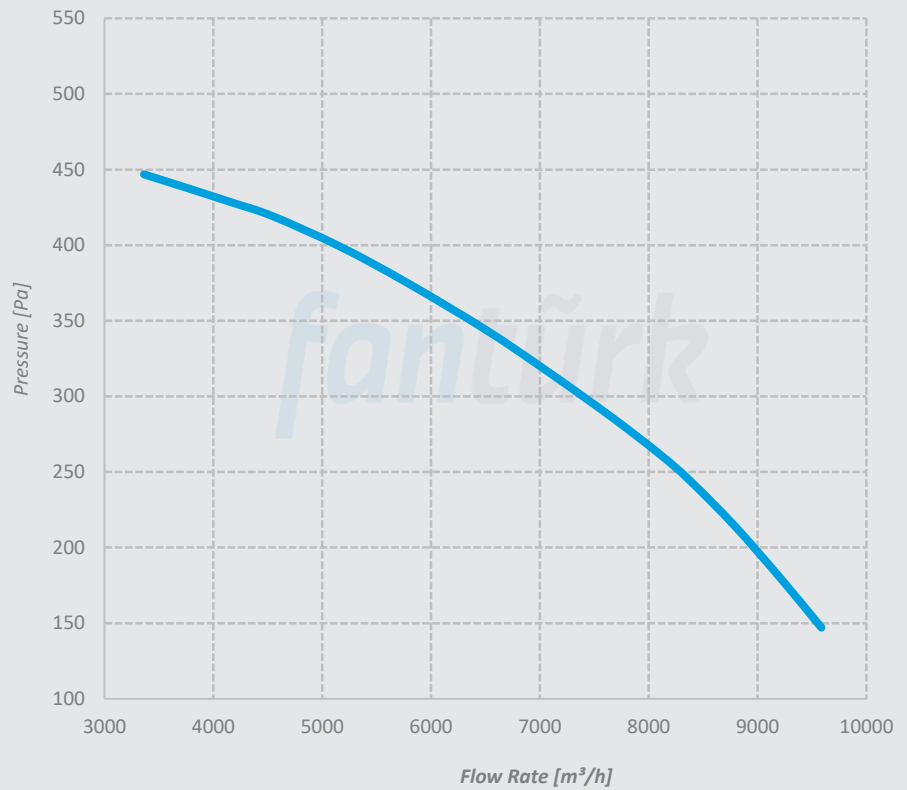

### ABF 400/4

Voltage 380 V  
Frequency 50 Hz  
Motor Power 4 kW  
Motor Speed 1430 rpm  
Sound Pressure Level 73 dBA  
Weight 151 kg

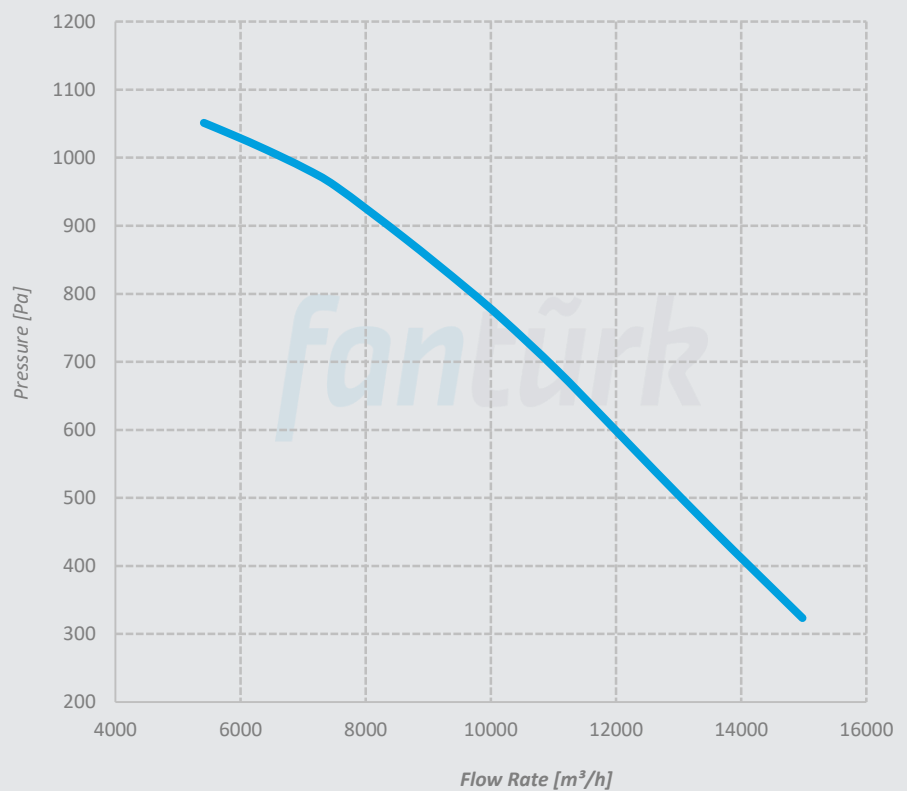

## Performance Curves

### ABF 450/2,2

Voltage 380 V  
Frequency 50 Hz  
Motor Power 2,2 kW  
Motor Speed 950 rpm  
Sound Pressure Level 68 dBA  
Weight 181 kg

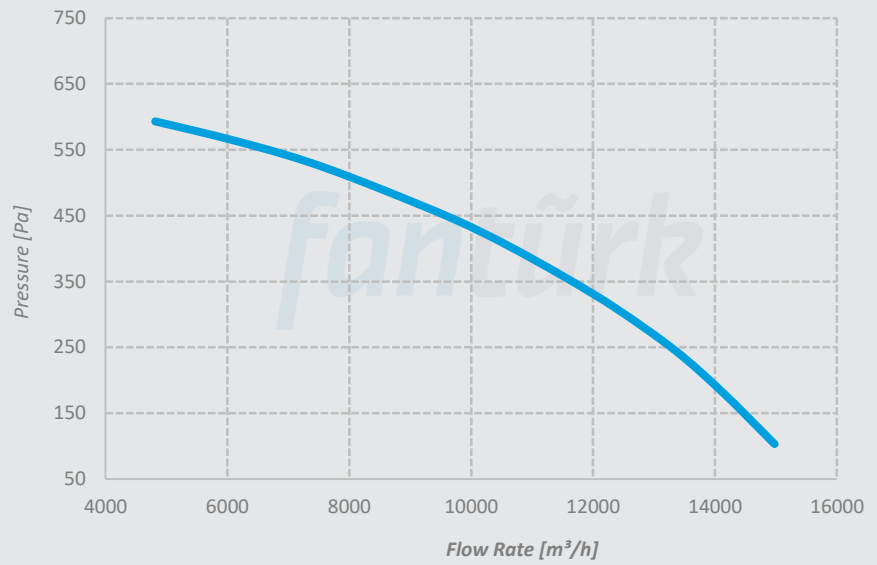

### ABF 450/5,5

Voltage 380 V  
Frequency 50 Hz  
Motor Power 5,5 kW  
Motor Speed 1440 rpm  
Sound Pressure Level 75 dBA  
Weight 198 kg

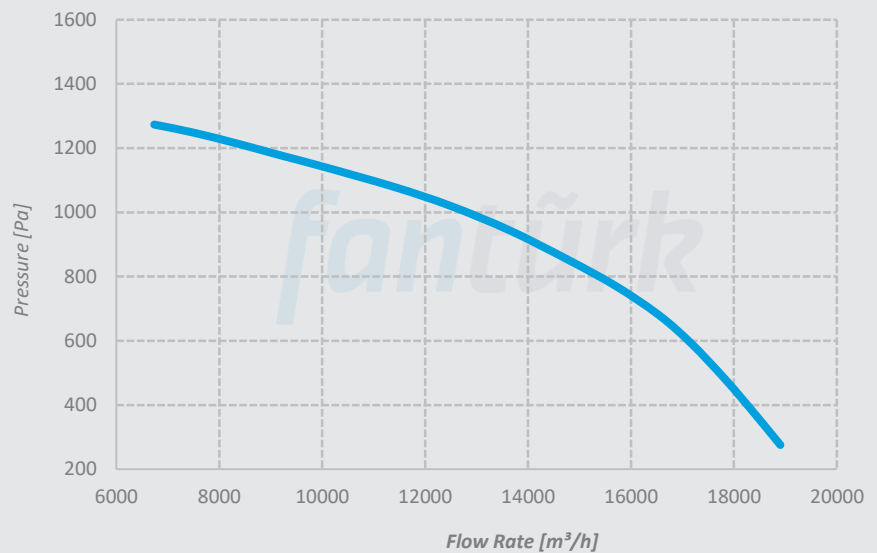

### ABF 450/7,5

Voltage 380 V  
Frequency 50 Hz  
Motor Power 7,5 kW  
Motor Speed 1450 rpm  
Sound Pressure Level 76 dBA  
Weight 208 kg

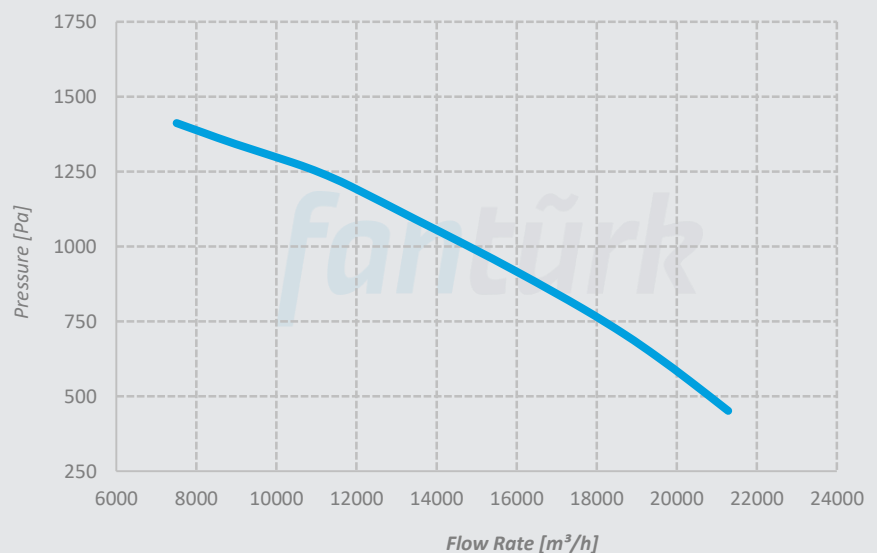

## Performance Curves

### ABF 500/4

Voltage 380 V  
Frequency 50 Hz  
Motor Power 4 kW  
Motor Speed 960 rpm  
Sound Pressure Level 71 dBA  
Weight 246 kg

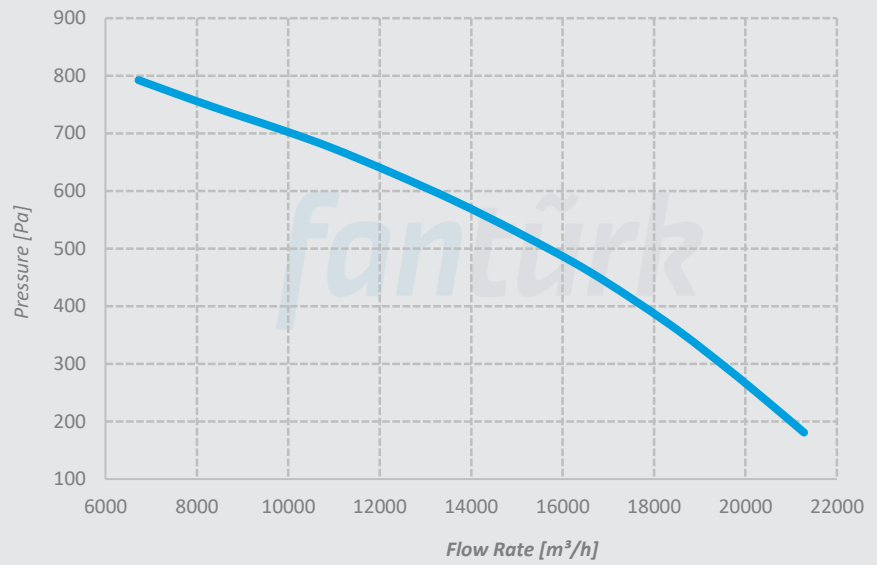

### ABF 500/11

Voltage 380 V  
Frequency 50 Hz  
Motor Power 11 kW  
Motor Speed 1460 rpm  
Sound Pressure Level 78 dBA  
Weight 296 kg

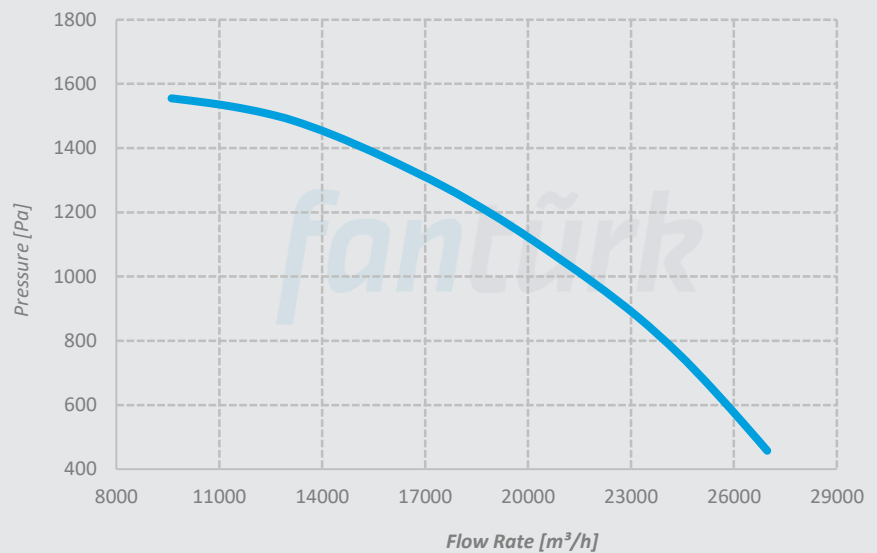

### ABF 500/15

Voltage 380 V  
Frequency 50 Hz  
Motor Power 15 kW  
Motor Speed 1460 rpm  
Sound Pressure Level 79 dBA  
Weight 302 kg

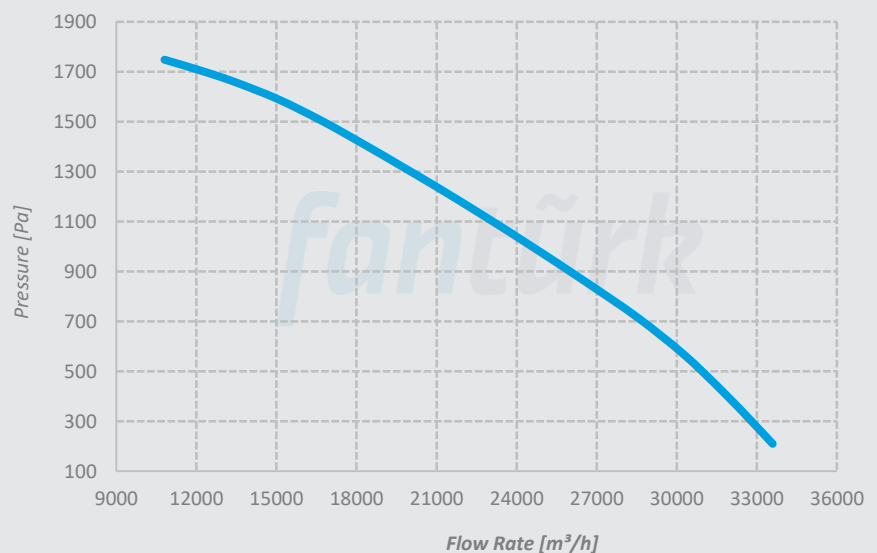

## Performance Curves

### ABF 560/5,5

Voltage 380 V  
Frequency 50 Hz  
Motor Power 5,5 kW  
Motor Speed 950 rpm  
Sound Pressure Level 74 dBA  
Weight 315 kg

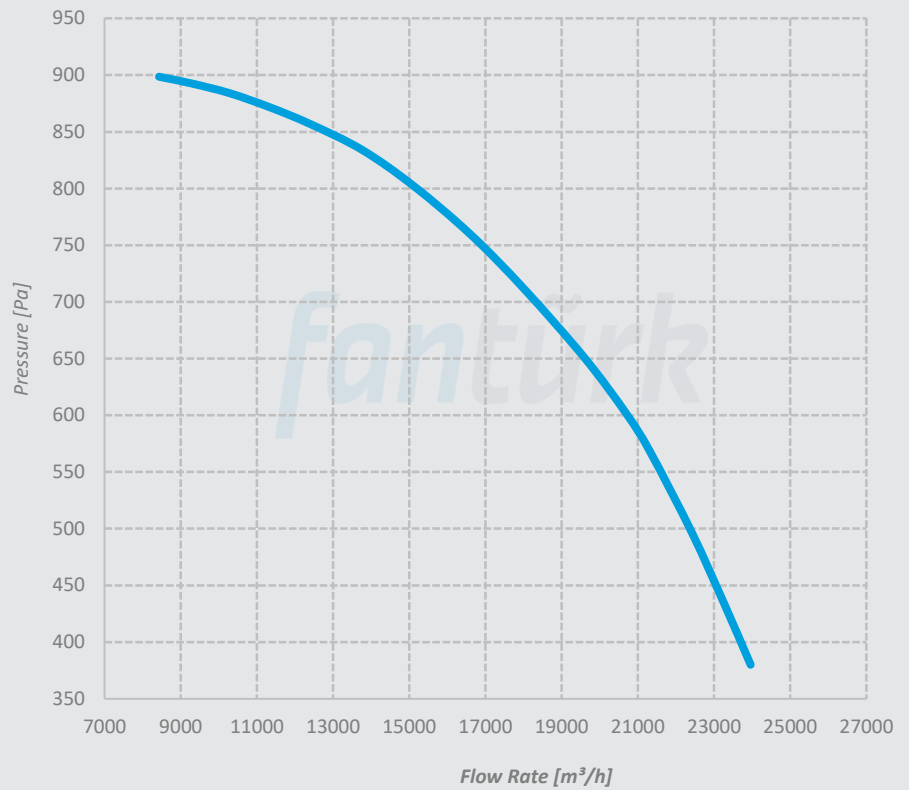

### ABF 560/7,5

Voltage 380 V  
Frequency 50 Hz  
Motor Power 7,5 kW  
Motor Speed 960 rpm  
Sound Pressure Level 75 dBA  
Weight 349 kg

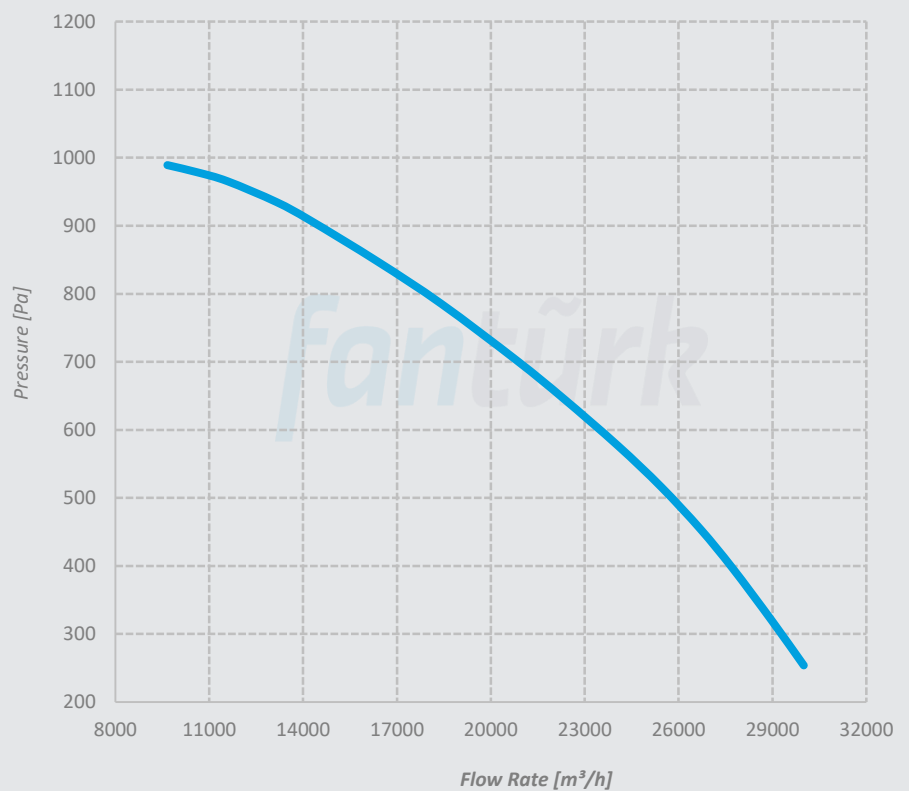

## Performance Curves

### ABF 560/18,5

Voltage 380 V  
Frequency 50 Hz  
Motor Power 18,5 kW  
Motor Speed 1460 rpm  
Sound Pressure Level 82 dBA  
Weight 416 kg

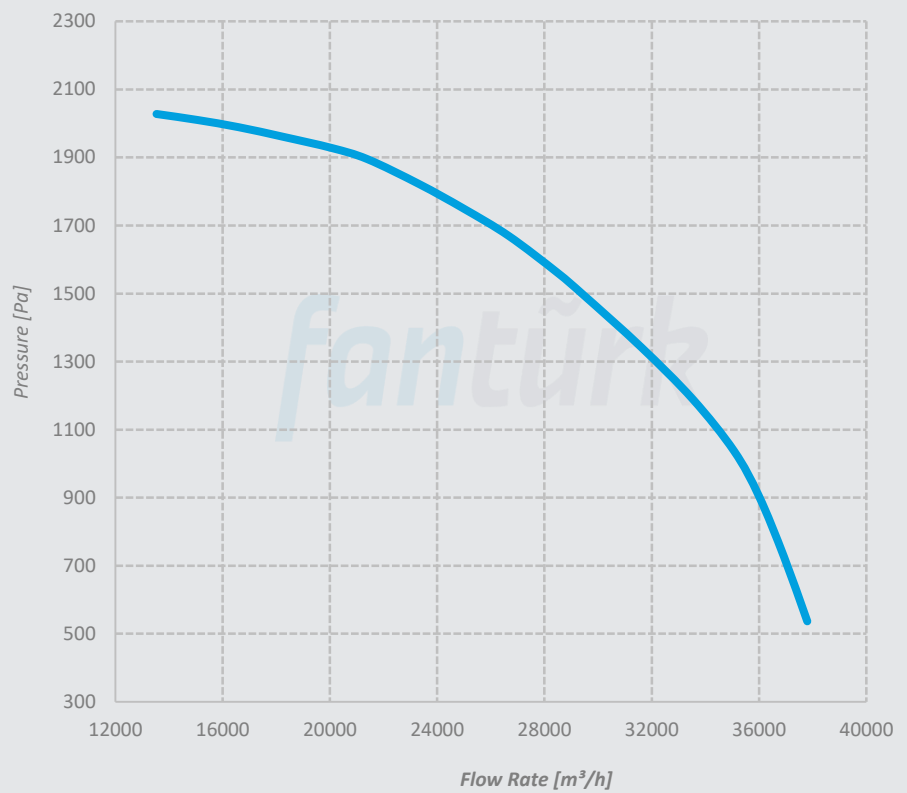

### ABF 560/22

Voltage 380 V  
Frequency 50 Hz  
Motor Power 22 kW  
Motor Speed 1460 rpm  
Sound Pressure Level 83 dBA  
Weight 426 kg

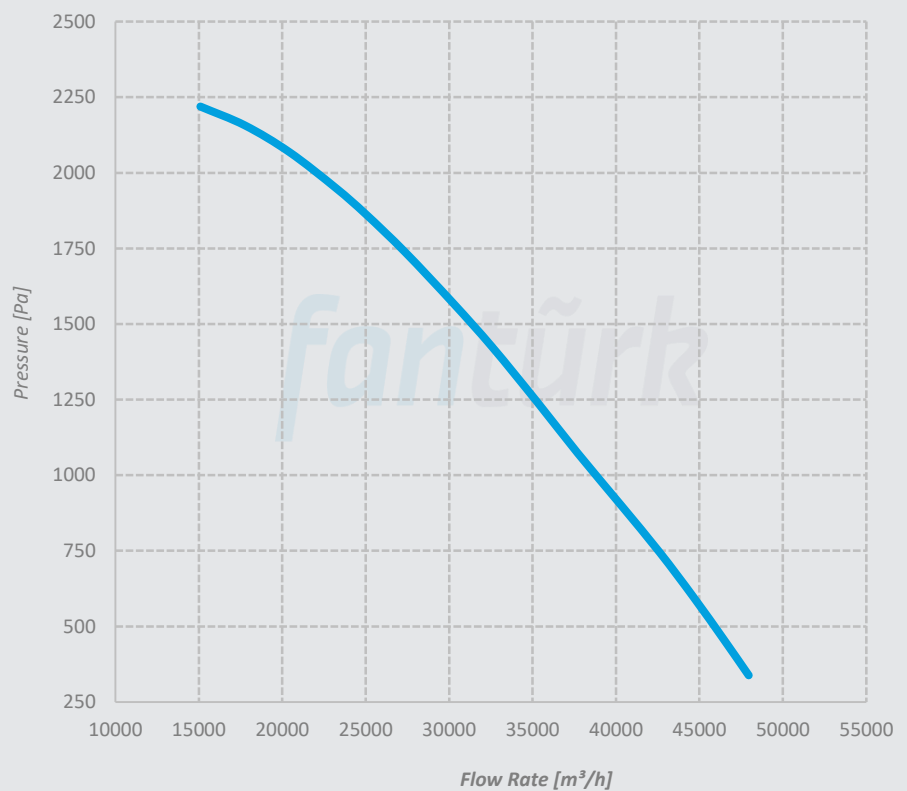



# OBF Medium Pressure Centrifugal Fan



## Technical Specifications

# MEDIUM PRESSURE CENTRIFUGAL FAN

OBF series are single suction high efficiency and low noise fans. The maximum temperature of the suction fluid should be 120 ° C. In order to work at a higher temperature, modifications to the fan manufacturing are required.

Made of high quality corrosion resistant S355 steel and coated with epoxy paint. Can be made of stainless steel for corrosive and high temperature environments. Fans are radial fans with backward curved blades. It is possible to drive the fan with belt pulley, direct coupling or elastic coupling.

Optionally, it can be manufactured with Ex-Proof feature.

### Usage Areas

It is suitable for use in dusty air suction, ventilation, drying, mechanical extraction, dust, sawdust or any kind of ventilation systems with toxic gas systems.

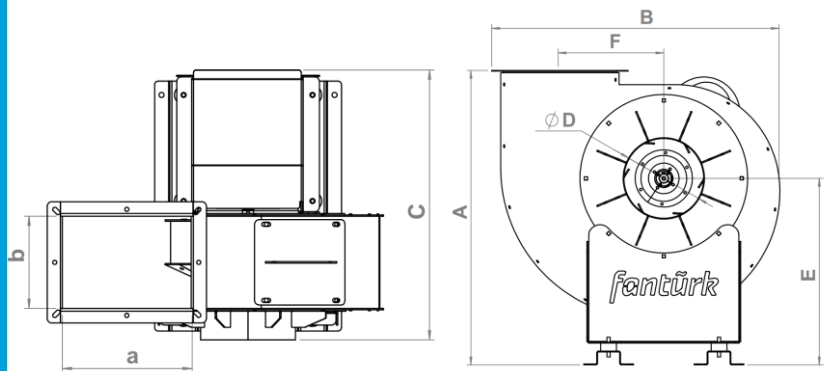

MODEL	A	B	C	Inlet ØD	Outlet a x b	E	F	VOLTAGE V	FREQUENCY Hz	MOTOR POWER kW	CURRENT A	MOTOR SPEED rpm	SOUND P. LEVEL dBA	WEIGHT kg
	mm	mm	mm	mm	mm	mm	mm							
OBF 100	440	415	395	105	140X100	263	135	380	50	0,18	0,55	2820	62	27
OBF 140	540	523	424	120	200x140	335	175	380	50	0,37	1,1	2800	65	39
OBF 160	605	588	460	150	225x160	375	205	380	50	0,55	1,3	2780	68	41
OBF 180	655	645	535	155	250x180	400	225	380	50	1,1	2,3	2900	72	48
OBF 200	746	778	585	206	280x200	472	263	380	50	2,2	4,5	2900	73	74
OBF 224	830	825	635	215	315x224	511	295	380	50	4	7,9	2910	77	100
OBF 250	903	913	716	225	355x250	562	327	380	50	7,5	13,6	2910	82	128
OBF 280	1005	1025	875	240	400x280	635	370	380	50	11	19,5	2945	84	173
OBF 315	1095	1145	900	340	450x315	702	407	380	50	18,5	32,3	2950	87	233



## Fan Directions



The centrifugal fan direction must be specified when ordering.

To determine the fan direction, one of the following options is selected when looking from the motor side.



<b>Counter Clockwise</b>	<b>TR</b> Top Right	<b>TR45</b> Top Right 45°	<b>LT</b> Left Top	<b>LT45</b> Left Top 45°
	<b>BL</b> Bottom Left	<b>BL45</b> Bottom Left 45°	<b>RB</b> Right Bottom	<b>RB45</b> Right Bottom 45°
<b>Clockwise</b>	<b>TL</b> Top Left	<b>TL45</b> Top Left 45°	<b>RT</b> Right Top	<b>RT45</b> Right Top 45°
	<b>BR</b> Bottom Right	<b>BR45</b> Bottom Right 45°	<b>LB</b> Left Bottom	<b>LB45</b> Left Bottom 45°

## Performance Curves

### OBF 100/0,18

Voltage 380 V  
Frequency 50 Hz  
Motor Power 0,18 kW  
Motor Speed 2820 rpm  
Sound Pressure Level 62 dBA  
Weight 27 kg

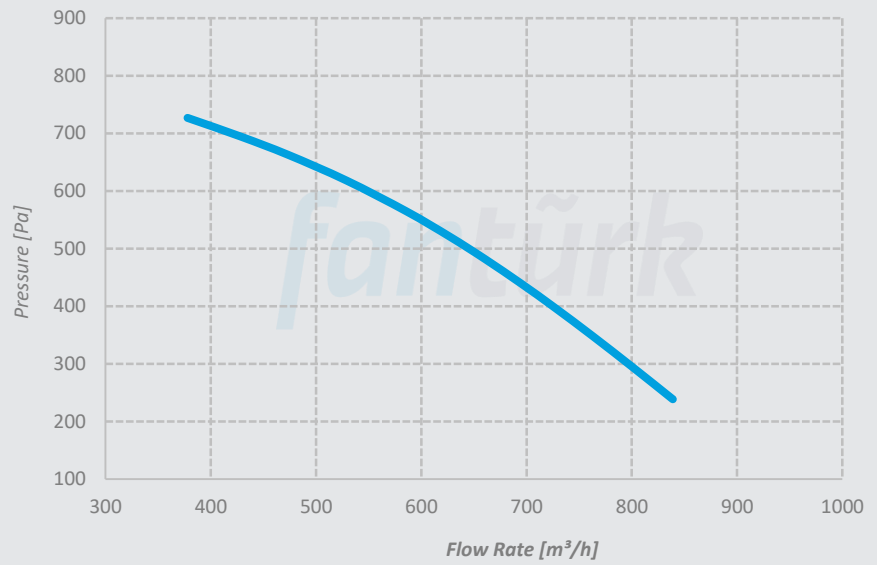

### OBF 140/0,37

Voltage 380 V  
Frequency 50 Hz  
Motor Power 0,37 kW  
Motor Speed 2800 rpm  
Sound Pressure Level 65 dBA  
Weight 39 kg

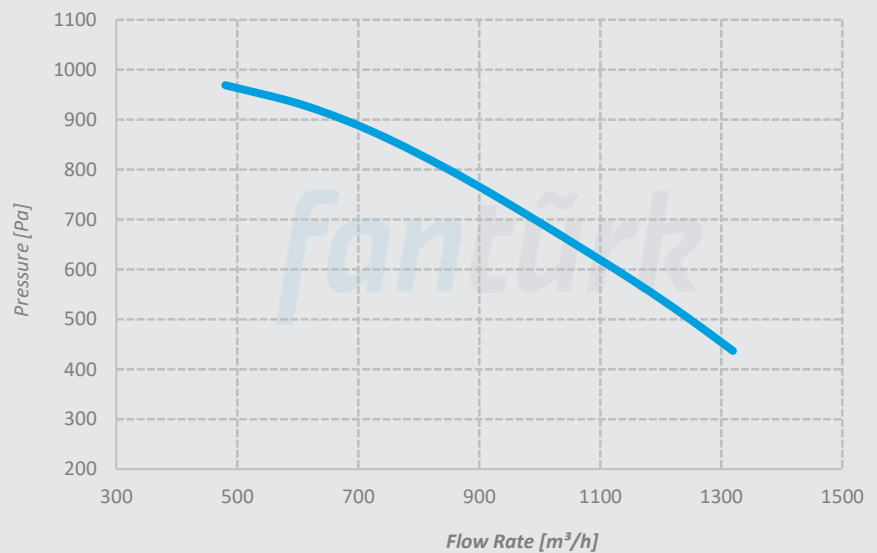

### OBF 160/0,55

Voltage 380 V  
Frequency 50 Hz  
Motor Power 0,55 kW  
Motor Speed 2780 rpm  
Sound Pressure Level 68 dBA  
Weight 41 kg

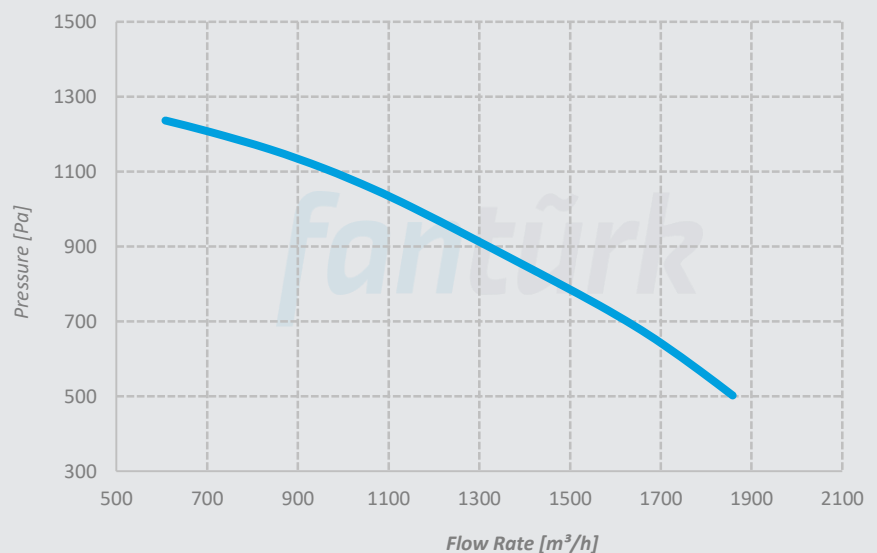

## Performance Curves

### OBF 180/1,1

Voltage 380 V  
Frequency 50 Hz  
Motor Power 1,1 kW  
Motor Speed 2900 rpm  
Sound Pressure Level 72 dBA  
Weight 48 kg

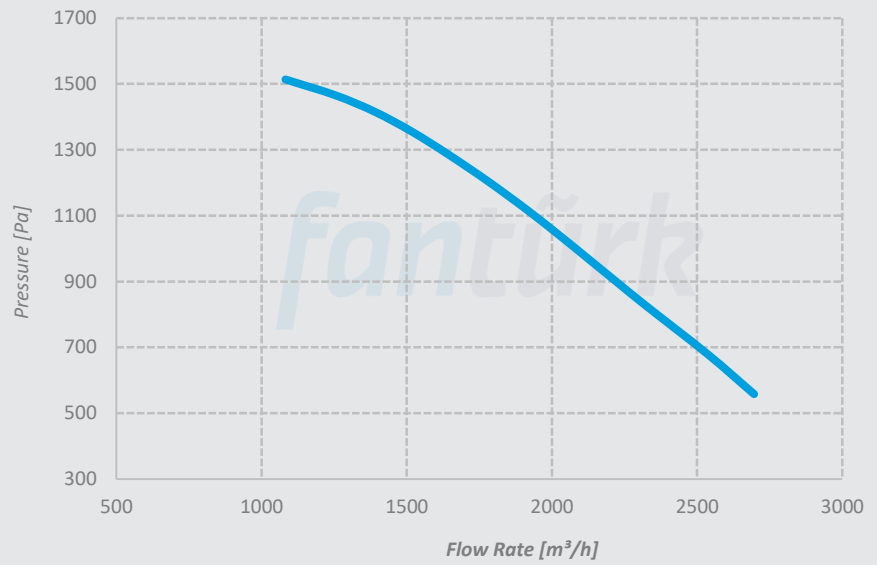

### OBF 200/2,2

Voltage 380 V  
Frequency 50 Hz  
Motor Power 2,2 kW  
Motor Speed 2900 rpm  
Sound Pressure Level 73 dBA  
Weight 74 kg

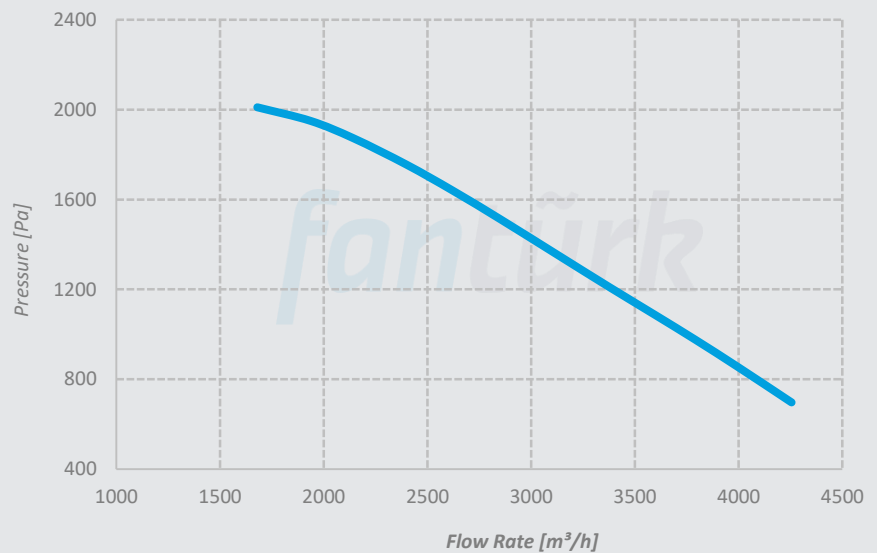

### OBF 224/4

Voltage 380 V  
Frequency 50 Hz  
Motor Power 4 kW  
Motor Speed 2910 rpm  
Sound Pressure Level 77 dBA  
Weight 100 kg

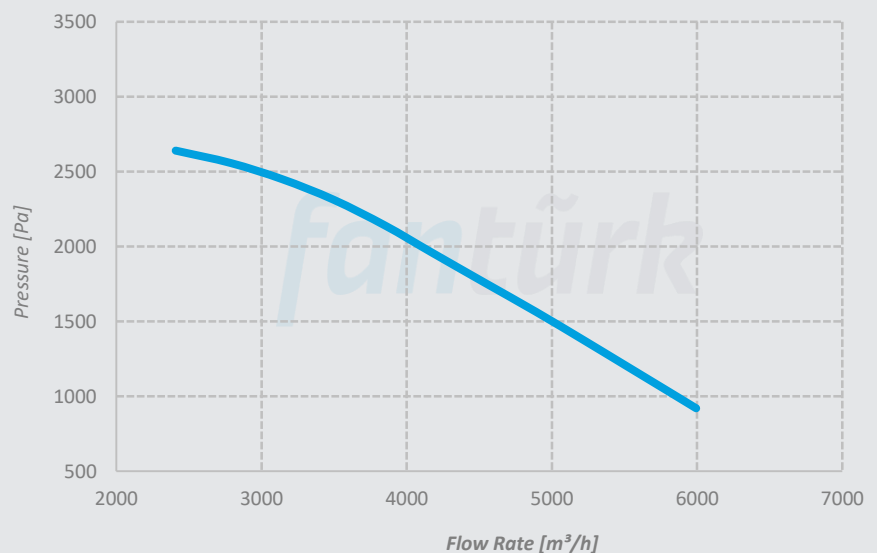

## Performance Curves

### OBF 250/7,5

Voltage 380 V  
Frequency 50 Hz  
Motor Power 7,5 kW  
Motor Speed 2910 rpm  
Sound Pressure Level 82 dBA  
Weight 128 kg

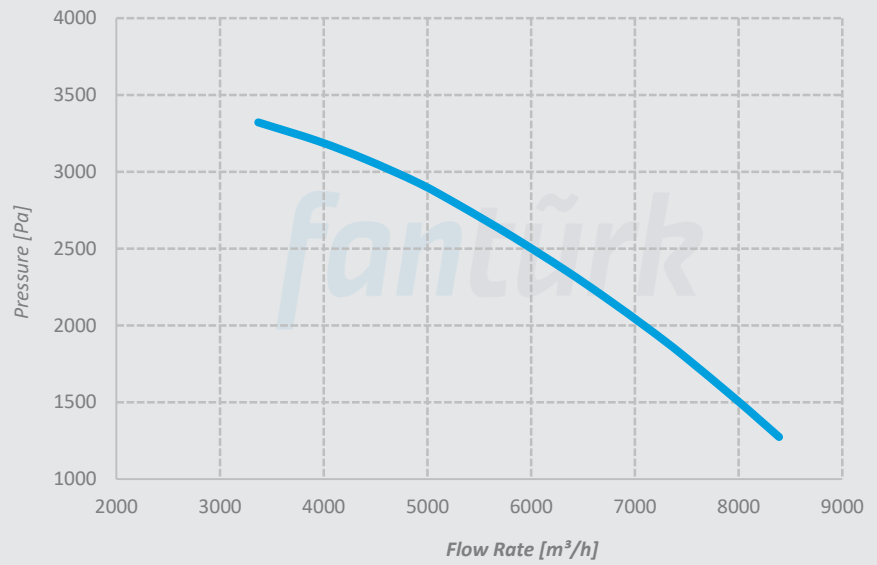

### OBF 280/11

Voltage 380 V  
Frequency 50 Hz  
Motor Power 11 kW  
Motor Speed 2945 rpm  
Sound Pressure Level 84 dBA  
Weight 173 kg

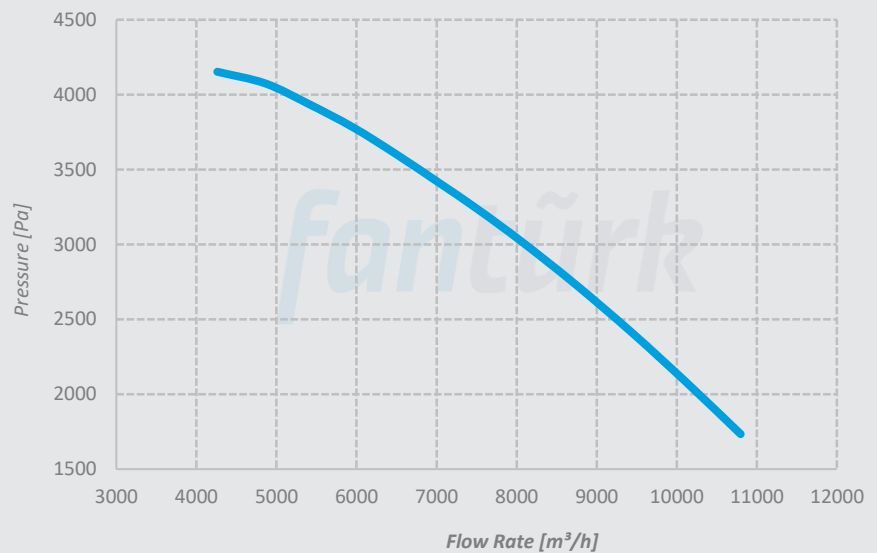

### OBF 315/18,5

Voltage 380 V  
Frequency 50 Hz  
Motor Power 18,5 kW  
Motor Speed 2950 rpm  
Sound Pressure Level 87 dBA  
Weight 233 kg

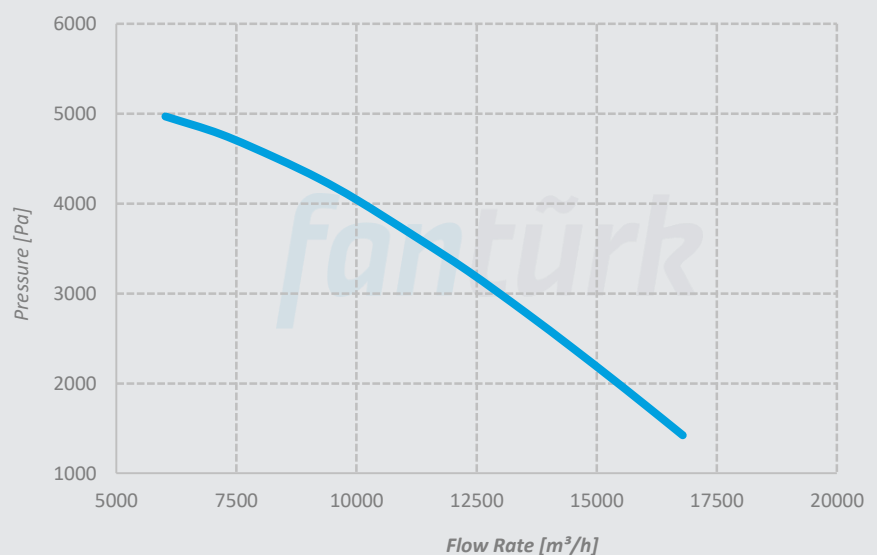



*R-APA  
Radial  
Unit Heater*



## Technical Specifications

# RADIAL UNIT HEATER

R-APA Series radial unit heaters are the ideal fans to meet the heating needs of high ceiling areas. Thanks to their compact construction, they can be mounted directly on the wall. R-APA radial units have high performance, trouble-free operation.

As a standard, with 90/70 °C hot water working regime, produced in the capacity of 5.000 – 60.000 kcal/h. Upon request, can be produced according to working conditions with superheated water or steam.

Made of high quality corrosion resistant galvanized steel. Directly coupled backward curved bladed radial fan is used for air blowing. Heater coil is manufactured as copper pipe aluminum finned. It is manufactured as standard (380 V - 50 Hz) or other voltages and frequencies. Motors can be single-speed or double speed and have Class H, S1, IP55 insulation.

### Usage Areas

It can be used in closed areas, warehouses, hangars, workshops, gyms, garages, production facilities with a ceiling height exceeding 4m.

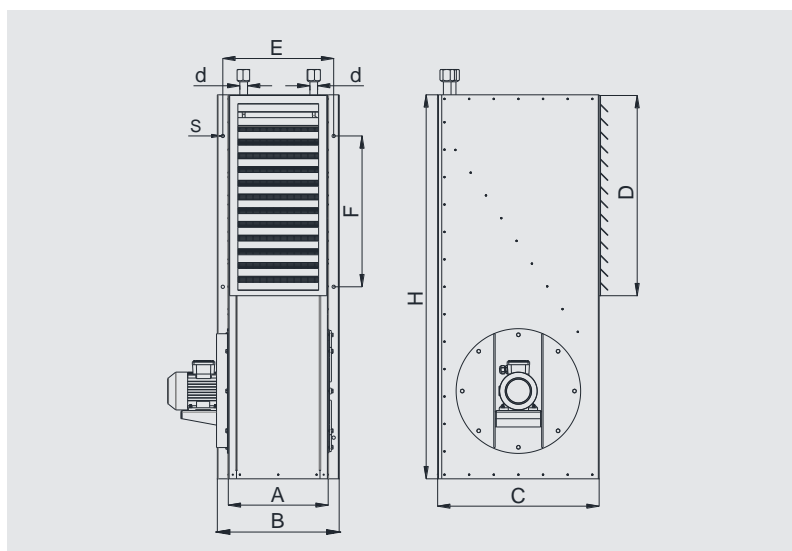

MODEL	A	B	C	D	E	F	H	S	d	VOLTAGE	FREQUENCY	MOTOR POWER	MOTOR SPEED	FLOW RATE	HEATER CAPACITY	SOUND PRESSURE LEVEL	WEIGHT	
	mm	mm	mm	mm	mm	mm	mm	mm	mm	V	Hz	kW	rpm	m <sup>3</sup> /h	kcal/h	kW	dBa	kg
R-APA-5	260	340	520	510	300	320	940	12	¾"	380	50	0,25	1380	1300	5000	5,8	72	66
R-APA-6	260	340	520	510	300	320	940	12	¾"	380	50	0,25	1380	1300	6000	7,0	72	66
R-APA-8	260	340	520	510	300	320	940	12	¾"	380	50	0,25	1380	1300	8000	9,3	72	78
R-APA-10	260	340	520	510	300	320	940	12	¾"	380	50	0,25	1380	1300	10000	11,6	72	78
R-APA-12	350	430	520	590	390	420	1135	12	1"	380	50	0,25	1380	2200	12000	14,0	74	96
R-APA-18	350	430	520	590	390	420	1135	12	1"	380	50	0,25	1380	2200	16000	18,6	74	116
R-APA-20	350	430	520	590	390	420	1135	12	1"	380	50	0,25	1380	2200	20000	23,3	74	133
R-APA-24	365	445	590	730	405	550	1400	12	1"	380	50	0,37	1390	3300	24000	27,9	75	149
R-APA-28	365	445	590	730	405	550	1400	12	1"	380	50	0,37	1390	3300	28000	32,6	75	149
R-APA-32	365	445	590	730	405	550	1400	12	1"	380	50	0,37	1390	3300	32000	37,2	75	172
R-APA-40	455	530	640	1010	490	690	1680	12	1 ¼"	380	50	0,75	1370	5300	40000	46,5	76	223
R-APA-50	455	530	640	1010	490	690	1680	12	1 ¼"	380	50	0,75	1370	5300	50000	58,1	76	261
R-APA-60	455	530	640	1010	490	690	1680	12	1 ¼"	380	50	0,75	1370	5300	60000	69,8	76	265



# A-APA Axial Unit Heater



## Technical Specifications

# AXIAL UNIT HEATER

A-APA series axial unit heaters are the ideal fans to meet the heating needs of high ceiling areas. A wall-mounted construction is used for mounting. A-APA axial units have high performance, trouble-free operation.

As a standard, with 90/70 °C hot water working regime, produced in the capacity of 4.100 – 24.200 kcal/h. Upon request, can be produced according to working conditions with superheated water or steam.

Made of high quality corrosion resistant galvanized steel. Directly coupled backward curved bladed radial fan is used for air blowing. Heater coil is manufactured as copper pipe aluminum finned. It is manufactured as standard (380 V - 50 Hz) or other voltages and frequencies. Motors can be single-speed or double speed and have Class F, S1, IP55 insulation.

### Usage Areas

Can be used in closed areas, warehouses, hangars, workshops, gyms, garages, production facilities with a ceiling height exceeding 4m.

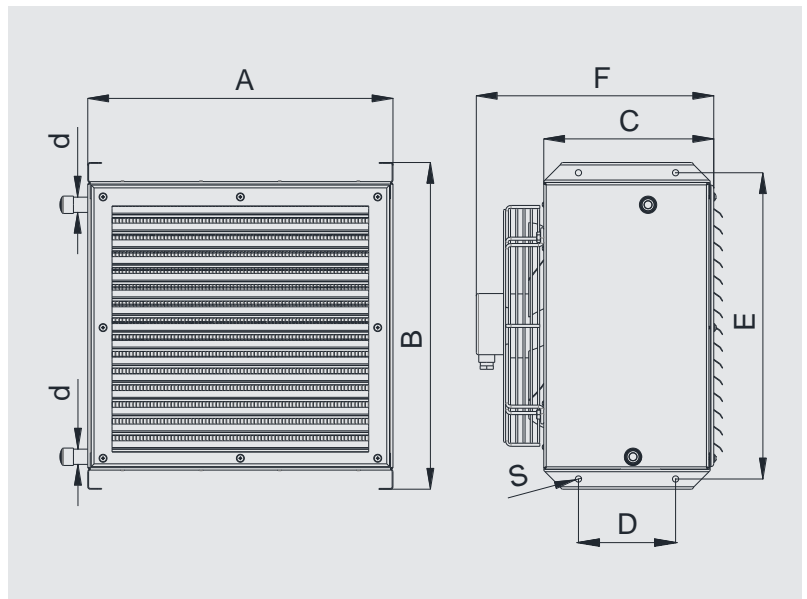
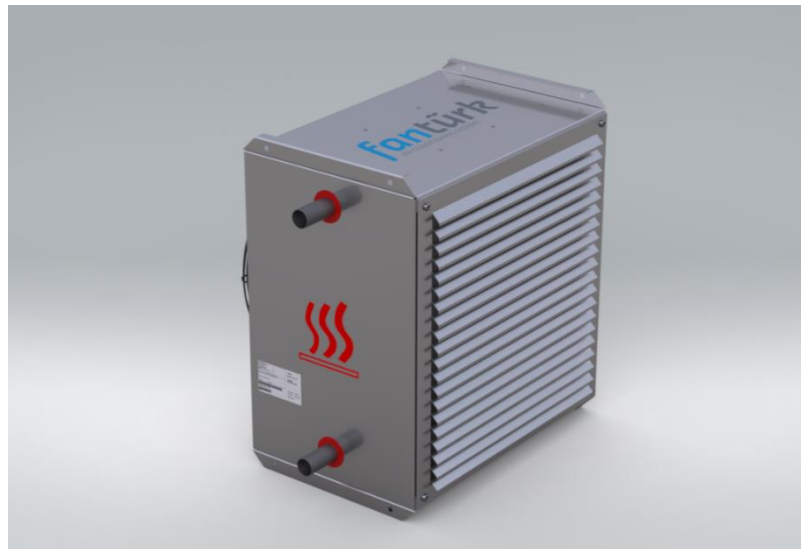

MODEL	A	B	C	D	E	F	S	d	VOLTAGE	FREQUENCY	MOTOR POWER	FLOW RATE	HEATER CAPACITY	SOUND PRESSURE LEVEL	WEIGHT	
	mm	mm	mm	mm	mm	mm	mm	inç	V	Hz	W	m <sup>3</sup> /h	kcal/h	kW	dBa	kg
A-APA 6	460	475	230	140	443	325	4,5	¾"	230	50	50	800	4100	4,8	55	17
A-APA 10	460	475	230	140	443	325	4,5	¾"	230	50	90	1200	6000	7,0	60	19
A-APA 12	460	475	230	140	443	325	4,5	¾"	230	50	90	1400	8600	10,0	52	20
A-APA 16	460	475	230	140	443	325	4,5	¾"	230	50	138	1600	11000	12,8	53	22
A-APA 20	460	475	230	140	443	325	4,5	¾"	230	50	138	1725	12700	14,8	60	22
A-APA 24	555	565	300	160	535	425	4,5	1"	230	50	138	1800	16400	19,1	62	27
A-APA 32	555	565	300	160	535	425	4,5	1"	230	50	138	1900	20600	24,0	64	28
A-APA 40	555	565	300	160	535	425	4,5	1"	230	50	180	2450	24200	28,1	65	29



# INDUSTRIAL AIR CURTAIN

The new generation of industrial air curtains absorbs the conditioned air in the environment with the help of centrifugal fans and acts as a curtain between the outdoor environment and the indoor environment.

## Usage Areas

Can be used the doors of large volumes such as workshop, factory, production area, hangar, warehouse.

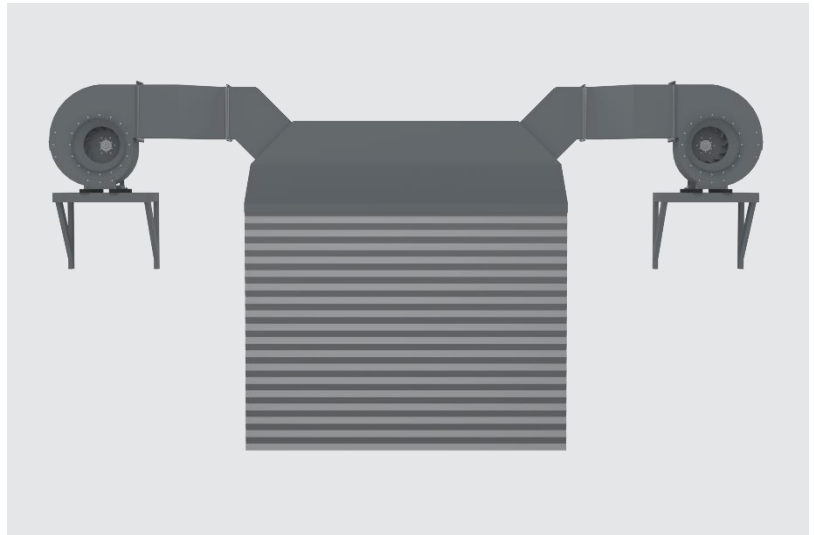

- It provides energy saving by preventing the passage of cold or hot air to the indoor environment and the passage of conditioned air to the outdoor environment.
- Particularly in food factories where hygiene requirements are sought, the passage of unwanted foreign substances is prevented.
- Shipment is safer.
- The vibration isolators and flexible connection in the system ensure a robust and quiet working environment.
- The inlet of the centrifugal fans covered for work safety.
- Thanks to PLC control, it works automatically with automatic door.



# DUST COLLECTION SYSTEM

Jet-Pulse system automatically removes the dusts. The Jet-Pulse Bag Filter Units are specially designed for demanding filtration conditions. All cabin body, chassis and carrier legs are produced with proper sheet thickness with bolt nut connectors. High efficient automatic cleaning system reduces compressed air consumption and increases filter life.

## Usage Areas

It is suitable for dust and chip collection systems of workshops such as workshops, factories, carpenter workshops.

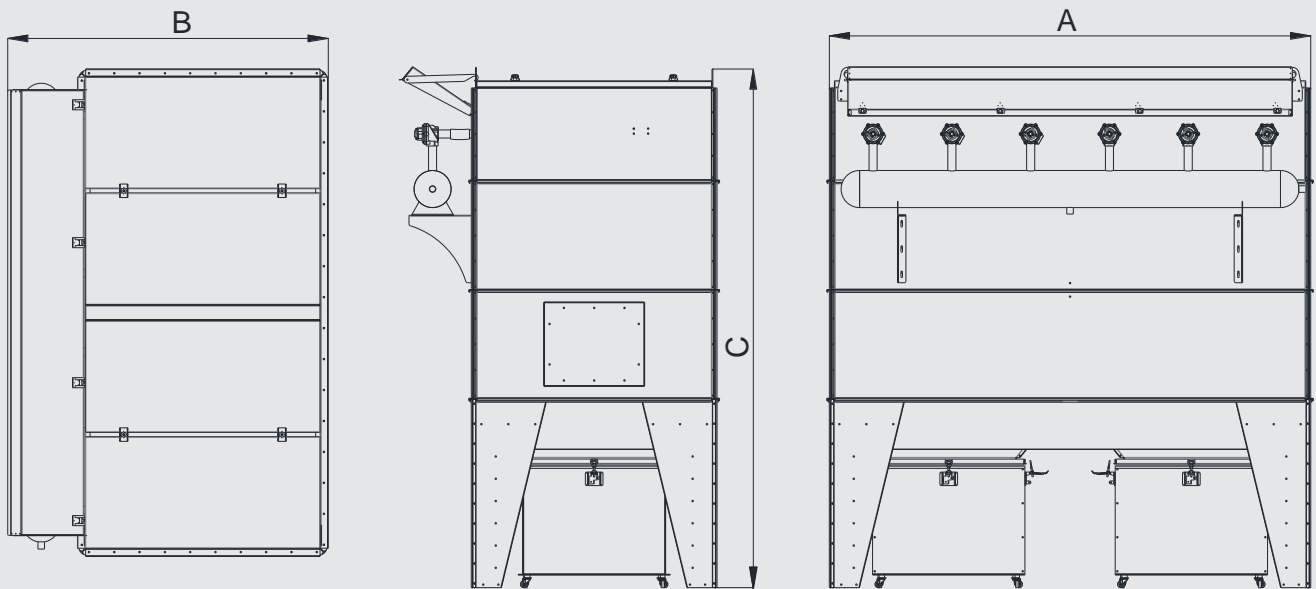

	A	B	C	TOTAL FILTER VOLUME	BUCKET VOLUME
MODEL	mm	mm	mm	m <sup>2</sup>	m <sup>3</sup> x pcs.
TT-10.000	1490	1900	3050	252	0,46 x 1
TT-20.000	2890	1900	3050	380	0,46 x 2

# Certificates



**FKS**  
Air Handling Units  
TSE-K Certificate



**IGK**  
Heat Recovery Unit  
TSE-K Certificate



**SHS**  
Duct Type Shelter Unit  
TSE-K Certificate



**TSE-K 453 Certificate**



**J-FWA**  
Axial Jet Fan  
F400 2H EN 12101-3



**R-FWA**  
Radial Jet Fan  
F400 2H EN 12101-3



**Y-FWA**  
Axial Smoke Exhaust Fan  
F400 2H EN 12101-3



**Ç-FWA**  
Rooftype Axial Smoke Fan  
F400 2H EN 12101-3



**T-FWA**  
Tunnel Jet Fan  
F400 2H EN 12101-3

# Certificates



ISO 9001:2015 Certificate



ISO 14001:2015 Certificate



ISO 45001:2018 Certificate

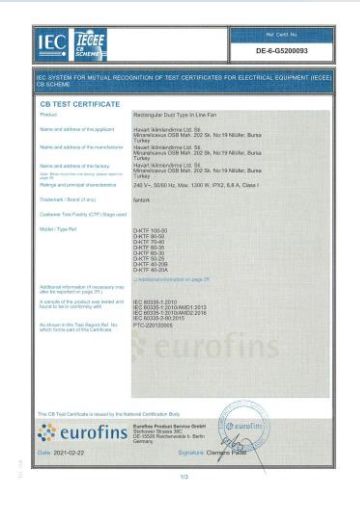

IECEE 60335-2 CB Test Certificate 220V ~ 240V

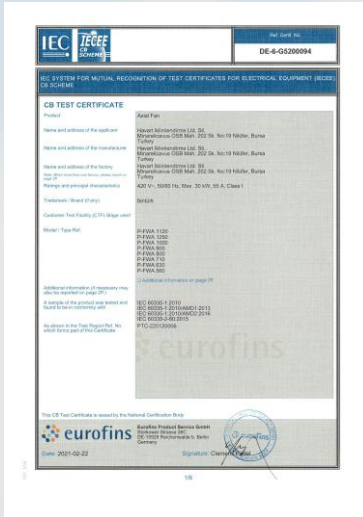

IECEE 60335-2 CB Test Certificate 380V ~ 415V



CE Certificates 220V ~ 240V

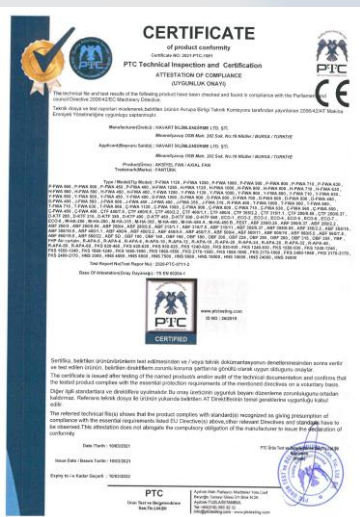

CE Certificates 380V ~ 415V



LVD Reports 220V ~ 240V



LVD Reports 380V ~ 415V

# Certificates



GOST Certificate



ATEX Certificate

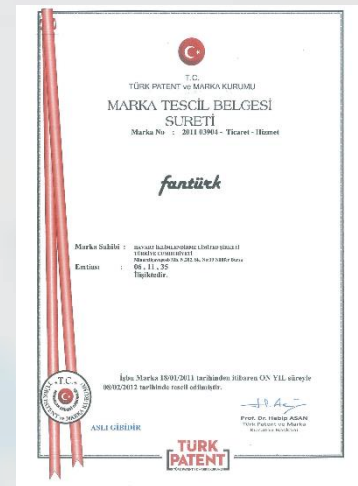

Fantürk Trademark Registration Certificate

*Headquarter: Beşevler Mah. Yıldırım Cad. No336 Nilüfer/Bursa Türkiye*

*Factory: Pamucak OSB Mah. 2. Cadde No: 14 Pazaryeri/Bilecik Türkiye*

*T: 90(224)482 2969 E: info@fanturk.com.tr*

*fanturk.com.tr*